

10G Ethernet SFP+ Active Optical Cable (AOC)

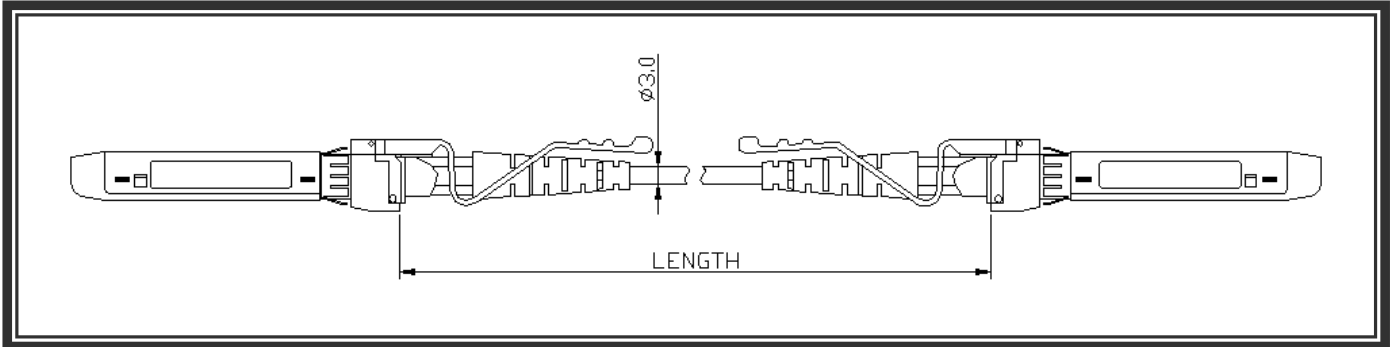

Description

The FIT Technologies' 2GACSM-00*G-EF Active Optical Cable (AOC) is part of a family of SFP+ products to serve 10Gb Ethernet (10GbE) applications. The 2GACSM-00*G-EF AOC enables 10GbE equipment designs with very high port density based on the new electrical and mechanical specification enhancements to the well known SFP specifications developed by the SFF Committee. The specifications are referred to as "SFP+" to represent the enhancements over previous SFP specifications. The SFP+ AOC have a cable length up to 20m. These AOCs can be used as an alternative solution to SFP+ passive and active copper cables, while providing improved signal integrity, longer distances, superior electromagnetic immunity and better bit error rate performance.

FIT P/N	Length	Description
2GACSM-X006G-EF	0.5M	SFP+ Active Optical Cable
2GACSM-A001G-EF	1M	SFP+ Active Optical Cable
2GACSM-X003G-EF	1.5M	SFP+ Active Optical Cable
2GACSM-X001G-EF	2M	SFP+ Active Optical Cable
2GACSM-X004G-EF	2.5M	SFP+ Active Optical Cable
2GACSM-B001G-EF	3M	SFP+ Active Optical Cable
2GACSM-X005G-EF	3.5M	SFP+ Active Optical Cable
2GACSM-C001G-EF	5M	SFP+ Active Optical Cable
2GACSM-X002G-EF	7M	SFP+ Active Optical Cable
2GACSM-D002G-EF	10M	SFP+ Active Optical Cable
2GACSM-E001G-EF	15M	SFP+ Active Optical Cable
2GACSM-L007G-EF	30M	SFP+ Active Optical Cable

Features

- Proven High Reliability 850 nm technology: FIT VCSEL transmitter and FIT PIN receiver
- Maximum power dissipation 350mW per Active Optical Cable end
- FIT SFP+ package design enables equipment EMI performance in high port density applications with margin to Class B limits

Specifications

- Electrical specifications per SFF-8431 Specifications for Enhanced Small Form Factor Pluggable Module SFP+
- 0 to 70°C case temperature operating range
- Rx_LOS and Tx_DISABLE supported
- Mechanical specifications per SFF Committee SFF 8432 Improved Pluggable Form factor "IPF"

- Compliant to Restriction on Hazardous Substances (RoHS) per EU and China requirements
- Class 1 eye safe per requirement of EN 60825-1 2007,EN 60825-2 A2 2010
- 1E-12 BER performance

Applications

- 1/10 Gigabit Ethernet (1/10GbE)
- 1/2/4/8G Fibre Channel (1/2/4/8GFC), Fibre Channel over Ethernet (FCoE)
- InfiniBand (QDR/DDR/SDR)
- Data Center Networking
 - Converged Enhanced Ethernet Data Centers
 - Data Center Bridging
- Networked storage systems
- High Performance Computing
- Proprietary Interconnects

Installation

The 2GACSMM-*00*G-EF Active Optical Cable package is compliant with the SFF-8432 Improved Pluggable Form factor housing specification for the SFP+. It can be installed in any INF-8074 or SFF-8431/2 compliant Small Form. Pluggable (SFP) port regardless of host equipment operating status The 2GACSMM-*00*G-EF is hot-pluggable, allowing both Active Optical Cable ends to be installed while the host system is operating and on-line. Upon insertion, the housing makes initial contact with the host board SFP cage, mitigating potential damage due to Electro-Static Discharge (ESD).

Digital Interface and Serial Identification

The two-wire interface protocol and signaling detail are based on SFF-8431. Conventional EEPROM memory, bytes 0-255 at memory address 0xA0, is organized in compliance with SFF-8431. The EEPROM contents of 2GACSMM-*00*G-EF are such that it can directly replace the Active Copper Cable.

Transmitter Section

The transmitter section includes an 850 nm VCSEL (Vertical Cavity Surface Emitting Laser) light source designed and manufactured by FIT Technologies. The VCSEL is driven by an IC which uses the incoming differential high speed logic signal to modulate the laser diode driver current. This Tx laser driver circuit regulates the optical power at a constant level provided the incoming data pattern is DC balanced. DC blocking capacitors are located inside the AOC package and are not required on the system board.

Transmitter Disable (TX-DISABLE)

Each end of the 2GACSMM-*00*G-EF AOC has a TX_DISABLE hardware pin, which accepts an input LVTTTL compatible control signal that shuts down the transmitter optical output. A logic high signal implements the transmitter disable function, while a low signal allows normal transmitter operation. An internal pull up resistor disables the transmitter until the host pulls the input low.

Receiver Section

The receiver section includes a PIN photodiode and custom amplification and quantization IC. DC blocking capacitors are located inside the AOC package and are not required on the system board.

Receiver Loss of Signal (Rx_LOS)

The Rx portion of the IC includes detection circuitry which monitors the average input Rx optical power and provides a LVTTTL/CMOS compatible status signal to the host via the Rx_LOS pin. A logic high status on this Rx_LOS output pin indicates a loss of signal, indicating a link failure such as a broken fiber, or the far-end cable-end is not plugged in, or the far-end Tx has failed or has been disabled.

Functional Data I/O

The 2GACSM-00G-EF interfaces with the host circuit board through the twenty contact SFP+ electrical connector. See Table 2 for contact descriptions. The device edge connector is shown in Figure 2. The 2GACSM-00G-EF high speed transmit and receive interfaces require SFF-8431 compliant signal lines on the host board. The TX_DISABLE and RX_LOS signals require LVTTTL signals on the host board (per SFF-8431) if used. If an application does not take advantage of these functions, care must be taken to ground TX_DISABLE to enable normal operation.

Application Support

An Evaluation Kit and Reference Designs are available to assist in evaluation of the 2GACSM-00G-EF. Please contact your local Field Sales representative for availability and ordering details.

Caution

There are no user serviceable parts nor maintenance requirements for the 2GACSM-00G-EF. All mechanical adjustments are made at the factory prior to shipment. Tampering with, modifying, misusing or improperly handling the 2GACSM-00G-EF will void the product warranty. It may also result in improper operation and possibly overstress the device. Performance degradation or device failure may result. Operating above maximum operating conditions or in a manner inconsistent with its design and function may result in exposure to hazardous light radiation and may constitute an act of modifying or manufacturing a laser product. Persons performing such an act are required by law to recertify and re-identify the laser product under the provisions of U.S. 21 CFR (Subchapter J) and TUV.

Customer Manufacturing Processes

This AOC is pluggable and is not designed for aqueous wash, IR reflow, or wave soldering processes.

Regulatory Compliance

The 2GACSM-00G-EF complies with all applicable laws and regulations as detailed in Table 1. Certification level is dependent on the overall configuration of the host equipment. The AOC performance is offered as a figure of merit to assist the designer.

Electrostatic Discharge (ESD)

The 2GACSM-00-G-EF is compatible with ESD levels found in typical manufacturing and operating environments as described in Table 1. In the normal handling and operation of optical cables, ESD is of concern in two circumstances.

The first case is during handling of the AOC prior to insertion into an SFP+ compliant cage. To protect the device, it's important to use normal ESD handling pre-cautions. These include use of grounded wrist straps, work-benches and floor wherever a optical cable is handled. The second case to consider is static discharges to the exterior of the host equipment chassis after installation. If the optical interface is exposed to the exterior of host equipment cabinet, the optical cable may be subject to system level ESD requirements.

Electromagnetic Interference (EMI)

Equipment incorporating 10 gigabit transceivers or active optical cables is typically subject to regulation by the FCC in the United States, CENELEC EN55022 (CISPR 22) in Europe and VCCI in Japan. The 2GACSM-00-G-EF enables equipment compliance to these standards detailed in Table 1. The metal housing and shielded design of the 2GACSM-00-G-EF minimizes the EMI challenge facing the equipment designer. For superior EMI performance it is recommended that equipment designs utilize SFP+ cages per SFF 8432.

RF Immunity (Susceptibility)

The EMI immunity of the 2GACSM-00-G-EF exceeds typical industry standards.

Eye Safety Flammability

The 2GACSM-00-G-EF provides Class 1 (single fault tolerant) eye safety by design and has been tested for compliance with the requirements listed in Table 1. The eye safety circuit continuously monitors the optical output power level and will disable the transmitter upon detecting a condition beyond the scope of Class 1 certification. Such conditions can be due to inputs from the host board (Vcc fluctuation, unbalanced code) or a fault within the transceiver. US CDRH and EU TUV certificates are listed in table 1.

Flammability

The 2GACSM-00-G-EF optical cable is made of metal and high strength, heat resistant, chemical resistant and UL 94V-0 flame retardant plastic.

Table 1. Regulatory Compliance

Feature	Test Method	Performance
Electrostatic Discharge (ESD) to the Electrical Contacts	MIL-STD-883C Method 3015.4	Class 1 (> 2000 Volts)
Life Traffic ESD Immunity	IEC 61000-4-2	10 contacts of 8 kV on the electrical faceplate with device inserted into a panel.
Life Traffic ESD Immunity	IEC 61000-4-2	Air discharge of 15 kV (min.) contact to connector without damage.
Electromagnetic Interference (EMI)	FCC Class B CENELEC EN55022 Class B (CISPR 22A) VCCI Class A	System margins are dependent on customer board and chassis design.
RF Immunity	IEC 61000-4-3	Typically shows no measurable effect from a 10 V/m field swept from 80MHz to 1 GHz
Laser Eye Safety and Equipment Type Testing	EN 60825-1 2007, EN 60825-2 A2:2010	P _{out} : IEC AEL & US FDA CDRH Class 1
		
Component Recognition	Underwriters Laboratories and Canadian Standards Association Joint Component Recognition for Information Technology Equipment including Electrical Business Equipment	
RoHS Compliance	RoHS Directive 2002/95/EC and its amendment directives 6/6	SGS Test Report No. LPC/13392 (AD-1)/07 CTS Ref. CTS/07/3283/Avago
Flammability	Module: UL 94V-0 Cable: OFNR	

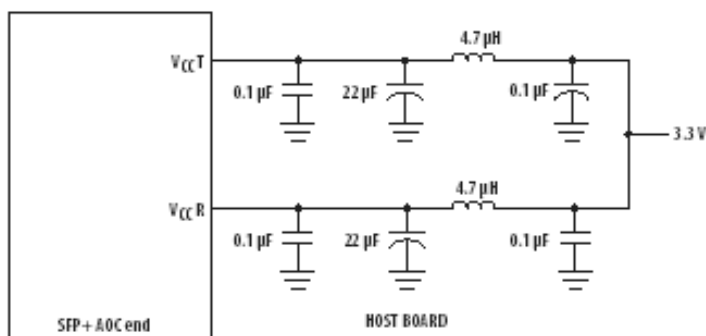

NOTE: INDUCTORS MUST HAVE LESS THAN 1% SERIES RESISTANCE TO LIMIT VOLTAGE DROP TO THE SFP MODULE.

Figure 1. Recommended power supply filter

Table 2. Contact Description

Contact	Symbol	Function/Description	Notes
1	VeeT	Transmitter Signal Ground	Note 1
2	TX_FAULT	Transmitter Fault (LVTTTL-O) – Not used. Grounded inside the module	Note 2
3	TX_DISABLE	Transmitter Disable (LVTTTL-I) – High or open disables the transmitter	Note 3
4	SDA	Two Wire Serial Interface Data Line (LVCMOS – I/O) (same as MOD-DEF 2 in INF-8074)	Note 4
5	SCL	Two Wire Serial Interface Clock Line (LVCMOS – I/O) (same as MOD-DEF 1 in INF-8074)	Note 4
6	MOD_ABS	Module Absent (Output), connected to VeeT or VeeR in the module	Note 5
7	RS0	Rate Select 0 - Not used, Presents high input impedance.	
8	RX_LOS	Receiver Loss of Signal (LVTTTL-O)	Note 2
9	RS1	Rate Select 1 - Not used, Presents high input impedance.	
10	VeeR	Receiver Signal Ground	Note 1
11	VeeR	Receiver Signal Ground	Note 1
12	RD-	Receiver Data Out Inverted (CML-O)	
13	RD+	Receiver Data Out (CML-O)	
14	VeeR	Receiver Signal Ground	
15	VccR	Receiver Power + 3.3 V	
16	VccT	Transmitter Power + 3.3 V	
17	VeeT	Transmitter Signal Ground	Note 1
18	TD+	Transmitter Data In (CML-I)	
19	TD-	Transmitter Data In Inverted (CML-I)	
20	VeeT	Transmitter Signal Ground	Note 1

Notes:

1. The module signal grounds are isolated from the module case.
2. This is an open collector/drain output that on the host board requires a 4.7 kΩ to 10 kΩ pullup resistor to VccHost. See Figure 2.
3. This input is internally biased high with a 4.7 kΩ to 10 kΩ pullup resistor to VccT.
4. Two-Wire Serial interface clock and data lines require an external pullup resistor dependent on the capacitance load.
5. This is a ground return that on the host board requires a 4.7 kΩ to 10 kΩ pullup resistor to VccHost.

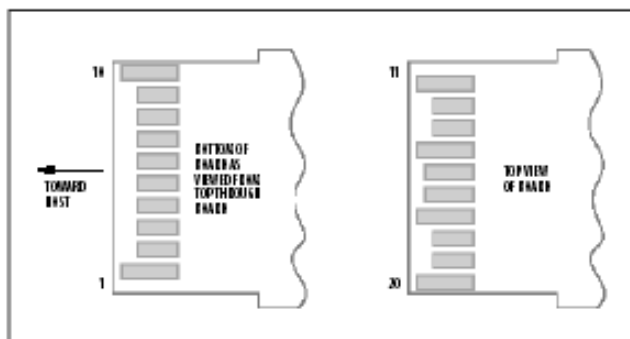

Figure 2. Module edge connector contacts

Table 3. Absolute Maximum Ratings

Stress in excess of any of the individual Absolute Maximum Ratings can cause immediate catastrophic damage to the module even if all other parameters are within Recommended Operating Conditions. It should not be assumed that limiting values of more than one parameter can be applied concurrently. Exposure to any of the Absolute Maximum Ratings for extended periods can adversely affect reliability.

Parameter	Symbol	Minimum	Maximum	Unit	Notes
Storage Temperature	T _S	-40	85	C	
Relative Humidity	RH	5	95	%	
Supply Voltage	V _{ccT} , V _{ccR}	-0.3	3.8	V	Note 1
Low Speed Input Voltage		-0.5	V _{cc} +0.5	V	
Two-Wire Interface Input Voltage		-0.5	V _{cc} +0.5	V	
High Speed Input Voltage, Single Ended		-0.3	V _{cc} +0.5	V	
High Speed Input Voltage, Differential			2.5	V	
Low Speed Output Current		-20	20	mA	

Table 4. Recommended Operating Conditions

Recommended Operating Conditions specify parameters for which the electrical and optical characteristics hold unless otherwise noted. Optical and electrical characteristics are not defined for operation outside the Recommended Operating Conditions, reliability is not implied and damage to the module may occur for such operation over an extended period of time.

Parameter	Symbol	Minimum	Maximum	Unit	Notes
Case Operating Temperature	T _C	0	70	°C	Note 2
Module Supply Voltage	V _{ccT} , V _{ccR}	3.135	3.465	V	Figure 3
Host Supply Voltage	V _{ccHost}	3.14	3.46	V	
Signal Rate 1-10.3125 GBd		-100	100	ppm	
Power Supply Noise Tolerance			66	10Hz to 10MHz	Figure 3
Tx Input Single Ended DC Voltage Tolerance (Ref V _{eeT})	V	-0.3	4.0	V	
Rx Output Single Ended Voltage Tolerance	V	-0.3	4.0	V	
Bend Radius			30	mm	

Table 5. Low Speed Signal Electrical Characteristics

The following characteristics are defined over the Recommended Operating Conditions unless otherwise noted. Typical values are for T_C = 40°C, V_{ccT} and V_{ccR} = 3.3 V.

Parameter	Symbol	Minimum	Typical	Maximum	Unit	Notes
Module Supply Current	I _{CC}		83	107	mA	Note 3
Power Dissipation	P _{DISS}		275	350	mW	Note 4
TX_FAULT, RX_LOS	I _{OH}	-50		+37.5	μA	Note 5
	V _{OL}	-0.3		0.4	V	
TX_DISABLE	V _{IH}	2.0		V _{ccT} + 0.3	V	Note 6
	V _{IL}	-0.3		0.8	V	

Notes:

1. The module supply voltages, V_{ccT} and V_{ccR} must not differ by more than 0.5 V or damage to the device may occur.
2. Ambient operating temperature limits are based on the Case Operating Temperature limits and are subject to the host system thermal design.
3. Supply current includes both V_{ccT} and V_{ccR} connections.
4. Per port
5. Measured with a 4.7 kΩ load to V_{ccHost}.
6. TX_DISABLE has an internal 4.7 kΩ to 10 kΩ pull-up to V_{ccT}

Table 6. High Speed Signal Electrical Characteristics

The following characteristics are defined over the Recommended Operating Conditions unless otherwise noted. Typical values are for $T_c = 40^\circ\text{C}$, V_{ccT} and $V_{ccR} = 3.3\text{ V}$.

Parameter	Symbol	Minimum	Typical	Maximum	Unit	Notes
Tx Input Differential Voltage (TD +/-)	V_I	180		700	mV	Note 1; see Figure 3b
Tx Input Mask						See Figure 3b
Tx Input AC Common Mode Voltage Tolerance				15	mV (RMS)	
Tx Input Differential S-parameter (100 Ω Ref.)	SDD11					Note 3
Tx Input Differential to Common Mode Conversion (25 Ω Ref.)	SCD11			-10	dB	0.01-11.1 GHz
Rx Output Differential Voltage (RD +/-)	V_o	300		850	mV	Note 2
Rx Output Termination Mismatch @ 1MHz	ΔZ_m			5	%	
Rx Output AC Common Mode Voltage				7.5	mV (RMS)	Note 5
Rx Output Output Rise and Fall Time (20% to 80%)	t_r, t_f	28			ps	
Rx Output Total Jitter	TJ			0.70	Ulp-p	Note 7
Rx Output Deterministic Jitter	DJ			0.42	Ulp-p	
Rx Output Differential S-parameter	SDD22					Note 4
Rx Output Common Mode Reflection Coefficient (25 Ω Ref.)	SCC22			Note 6 -3	dB dB	0.01-2.5 GHz 2.5-11.1 GHz
Receiver Output Eye Mask						See Figure 3b

Notes:

1. Internally AC coupled and terminated (100 Ohm differential).
2. Internally AC coupled but requires an external load termination (100 Ohm differential).
3. Maximum reflection coefficient is expressed as $SDD11 = \text{Max}(-12 + 2 \cdot \sqrt{f}, -6.3 + 13 \cdot \log_{10}(f/5.5))$, for f in GHz.
4. Maximum reflection coefficient is expressed as $SDD22 = \text{Max}(-12 + 2 \cdot \sqrt{f}, -6.3 + 13 \cdot \log_{10}(f/5.5))$, for f in GHz.
5. The RMS value is measured by calculating the standard deviation of the histogram for one UI of the common mode signal.
6. Maximum reflection coefficient given by equation $SCC22(\text{dB}) < -7 + 1.6 \times f$, with f in GHz.
7. TJ measured at 1e-12

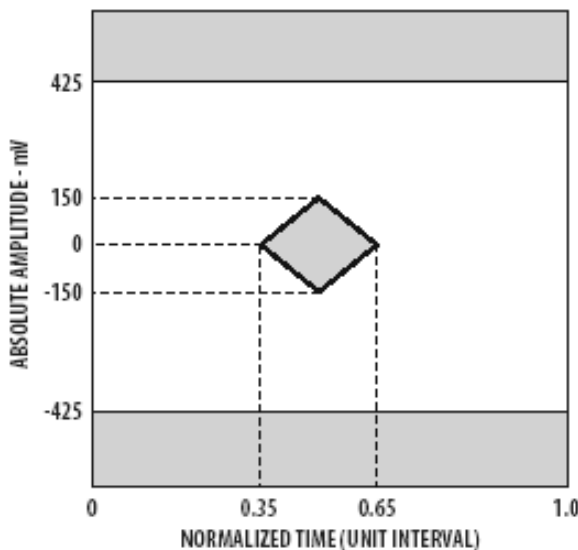

Figure 3a. Receiver Electrical Optical Eye Mask Definition

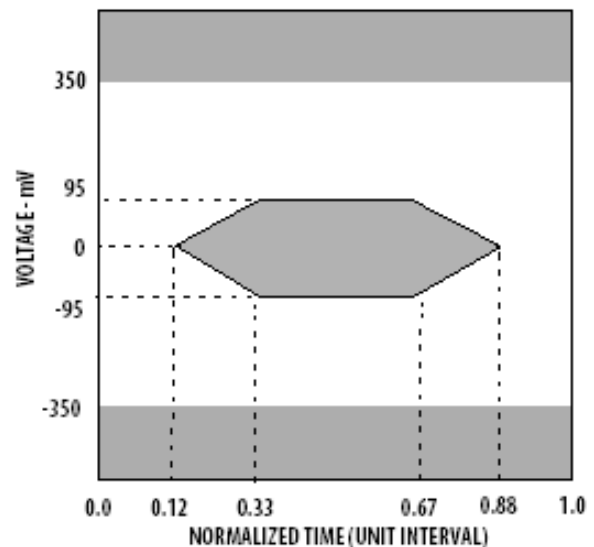

Figure 3b. Transmitter Differential Input Compliance Mask at B

Table 7. Two-Wire Interface Electrical Characteristics

Parameter	Symbol	Minimum	Maximum	Unit	Conditions
Host Vcc Range	VccHTWI	3.135	3.465	V	
SCL and SDA	V _{OL}	0.0	0.40	V	Rp ^[1] pulled to VccHTWI, measured at host side of connector
	V _{OH}	VccHTWI - 0.5	VccHTWI + 0.3	V	
SCL and SDA	V _{IL}	-0.3	VccT*0.3	V	
	V _{IH}	VccT*0.7	VccT + 0.5	V	
Input Current on the SCL and SDA Contacts	I _I	-10	10	μA	
Capacitance on SCL and SDA Contacts	C _i ^[2]		14	pF	
Total bus capacitance for SCL and for SDA	C _b ^[3]		100	pF	At 400 kHz, 3.0 kΩ Rp, max At 100 kHz, 8.0 kΩ Rp, max
			290	pF	At 400 kHz, 1.1 kΩ Rp, max At 100 kHz, 2.75 kΩ Rp, max

Notes:

1. Rp is the pull up resistor. Active bus termination may be used by the host in place of a pullup resistor. Pull ups can be connected to various power supplies, however the host board design shall ensure that no module contact has voltage exceeding VccT or VccR by 0.5 V nor requires the module to sink more than 3.0 mA current.
2. C_i is the capacitance looking into the module SCL and SDA contacts
3. C_b is the total bus capacitance on the SCL or SDA bus.

Table 8. Control Functions: Low Speed Signals Timing Characteristics

Parameter	Symbol	Maximum	Units	Notes
Time to Initialize	t_inti	300	ms	Note 1
TX_DISABLE Assert + RX_LOS Assert Time	t_los_on	110	us	Note 2
TX_DISABLE Negate + RX_LOS Deassert Time	t_los_off	2.1	ms	Note 3

Notes:

1. Time from power on or falling edge of TX_DISABLE to when the modulated optical output rises above 90% of nominal (not measurable in the Active Optical Cable) and the Two-Wire interface is available.
2. The maximum time between (a) when the near-end AOC-end has TX_DISABLE asserted until (b) RX_LOS is declared/asserted on the far-end AOC-end. There is also a small delay for the signal transit time through the optical cable, however, this is a small effect: light propagating through fiber ~ 5ns per meter. A 10 ms interval between assertions of TX_DISABLE is required.
3. The maximum time between (a) when the near-end AOC-end has TX_DISABLE negated until (b) RX_LOS is deasserted on the far-end AOC-end. There is also a small delay for the signal to transit time through the optical cable, however, this is a small effect: light propagating through fiber ~ 5 ns per meter

Table 9. EEPROM Serial ID Memory Contents – Address A0h
Page A0h only, per SFF-8472 Revision 11.0

Byte # Decimal	Byte # Hex	Default Value (Hex)	Notes	Type
0	0	03	Physical Device SFP/SFP+ = "03h"	Read-Only
1	1	04	Two Wire Serial Interface Function = "04h"	Read-Only
2	2	21	Copper pigtail	Read-Only
3	3	00	Not Applicable	Read-Only
4	4	00	Not Applicable	Read-Only
5	5	00	Not Applicable	Read-Only
6	6	00	Not Applicable	Read-Only
7	7	00	Unspecified	Read-Only
8	8	08	Active cable	Read-Only
9	9	00	Unspecified	Read-Only
10	A	00	Unspecified	Read-Only
11	B	00	Unspecified	Read-Only
12	C	67	10312.5 MB/s nominal rate = "67h"	Read-Only
13	D	00	Rate Select not implemented	Read-Only
14	E	00	Not Applicable	Read-Only
15	F	00	Not Applicable	Read-Only
16	10	00	Not Applicable	Read-Only
17	11	00	Not Applicable	Read-Only
18	12		Link length cable, units of meters (decimal)	Read-Only
19	13	00	Not Applicable	Read-Only
20	14	41	"A" - Vendor Name ASCII character	Read-Only
21	15	56	"V" - Vendor Name ASCII character	Read-Only
22	16	41	"A" - Vendor Name ASCII character	Read-Only
23	17	47	"G" - Vendor Name ASCII character	Read-Only
24	18	4F	"O" - Vendor Name ASCII character	Read-Only
25	19	20	"" - Vendor Name ASCII character	Read-Only
26	1A	20	"" - Vendor Name ASCII character	Read-Only
27	1B	20	"" - Vendor Name ASCII character	Read-Only
28	1C	20	"" - Vendor Name ASCII character	Read-Only
29	1D	20	"" - Vendor Name ASCII character	Read-Only
30	1E	20	"" - Vendor Name ASCII character	Read-Only
31	1F	20	"" - Vendor Name ASCII character	Read-Only
32	20	20	"" - Vendor Name ASCII character	Read-Only
33	21	20	"" - Vendor Name ASCII character	Read-Only
34	22	20	"" - Vendor Name ASCII character	Read-Only
35	23	20	"" - Vendor Name ASCII character	Read-Only
36	24	00	Not Used	Read-Only
37	25	00	Hex Byte of Vendor OUI[1]	Read-Only
38	26	17	Hex Byte of Vendor OUI[1]	Read-Only
39	27	6A	Hex Byte of Vendor OUI[1]	Read-Only

Table 9. EEPROM Serial ID Memory Contents – Address A0h (Cont.)

Byte # Decimal	Byte # Hex	Default Value (Hex)	Notes	Type
40	28	41	"A" - Vendor Part Number ASCII character	Read-Only
41	29	46	"F" - Vendor Part Number ASCII character	Read-Only
42	2A	42	"B" - Vendor Part Number ASCII character	Read-Only
43	2B	52	"R" - Vendor Part Number ASCII character	Read-Only
44	2C	2D	"-" - Vendor Part Number ASCII character	Read-Only
45	2D	32	"2" - Vendor Part Number ASCII character	Read-Only
46	2E	43	"C" - Vendor Part Number ASCII character	Read-Only
47	2F	41	"A" - Vendor Part Number ASCII character	Read-Only
48	30	52	"R" - Vendor Part Number ASCII character	Read-Only
49	31		x Cable Length in meters - Vendor Part Number ASCII character	Read-Only
50	32		x Cable Length in meters - Vendor Part Number ASCII character	Read-Only
51	33	5A	"Z" - Vendor Revision Number ASCII character	Read-Only
52	34	20	" " - Vendor Part Number ASCII character	Read-Only
53	35	20	" " - Vendor Part Number ASCII character	Read-Only
54	36	20	" " - Vendor Part Number ASCII character	Read-Only
55	37	20	" " - Vendor Part Number ASCII character	Read-Only
56	38	20	" " - Vendor Revision Number ASCII character	Read-Only
57	39	20	" " - Vendor Revision Number ASCII character	Read-Only
58	3A	20	" " - Vendor Revision Number ASCII character	Read-Only
59	3B	20	" " - Vendor Revision Number ASCII character	Read-Only
60	3C	04	Compliant to SFF-8431 Limiting = "04h"	Read-Only
61	3D	00	Not Applicable	Read-Only
62	3E	00	Not Used	Read-Only
63	3F		Checksum (Hex LSB Only) Bytes 0-62[2]	Read-Only
64	40	00	Uncooled Laser. Power Level 1 operation (1.0 Watt max). Limiting receiver output. = "00h"	Read-Only
65	41	12	Tx_Disable implemented & SFP Rx_LOS implemented = "12h"	Read-Only
66	42	00	Not Specified	Read-Only
67	43	00	Not Specified	Read-Only
68-83	44-53		Vendor Serial Number ASCII characters[3]	Read-Only
84-91	54-5B		Vendor Date Code ASCII characters[4]	Read-Only
92	5C	00	No Diagnostics = "00h"	Read-Only
93	5D	00	No Enhanced Options = "00h"	Read-Only
94	5E	00	Unspecified	Read-Only
95	5F		Checksum (Hex LSB Only) Bytes 64-94[2]	Read-Only
96-255	60-FF	00	VENDOR SPECIFIC ID FIELDS	Read-Only

Notes:

1. The IEEE Organizationally Unique Identifier (OUI) assigned to Avago Technologies is 00-17-6A (3 bytes hex).
2. Addresses 63 and 95 are checksums calculated (per SFF-8472) and stored prior to product shipment.
3. Addresses 68-83 specify the AFBR-2CARxxZ ASCII serial number and will vary on a per unit basis.
4. Addresses 84-91 specify the AFBR-2CARxxZ ASCII date code and will vary on a per date code basis.

FIT

Fiber-Optic SFP+ AOC
DOCUMENT NO:EB6-TBD

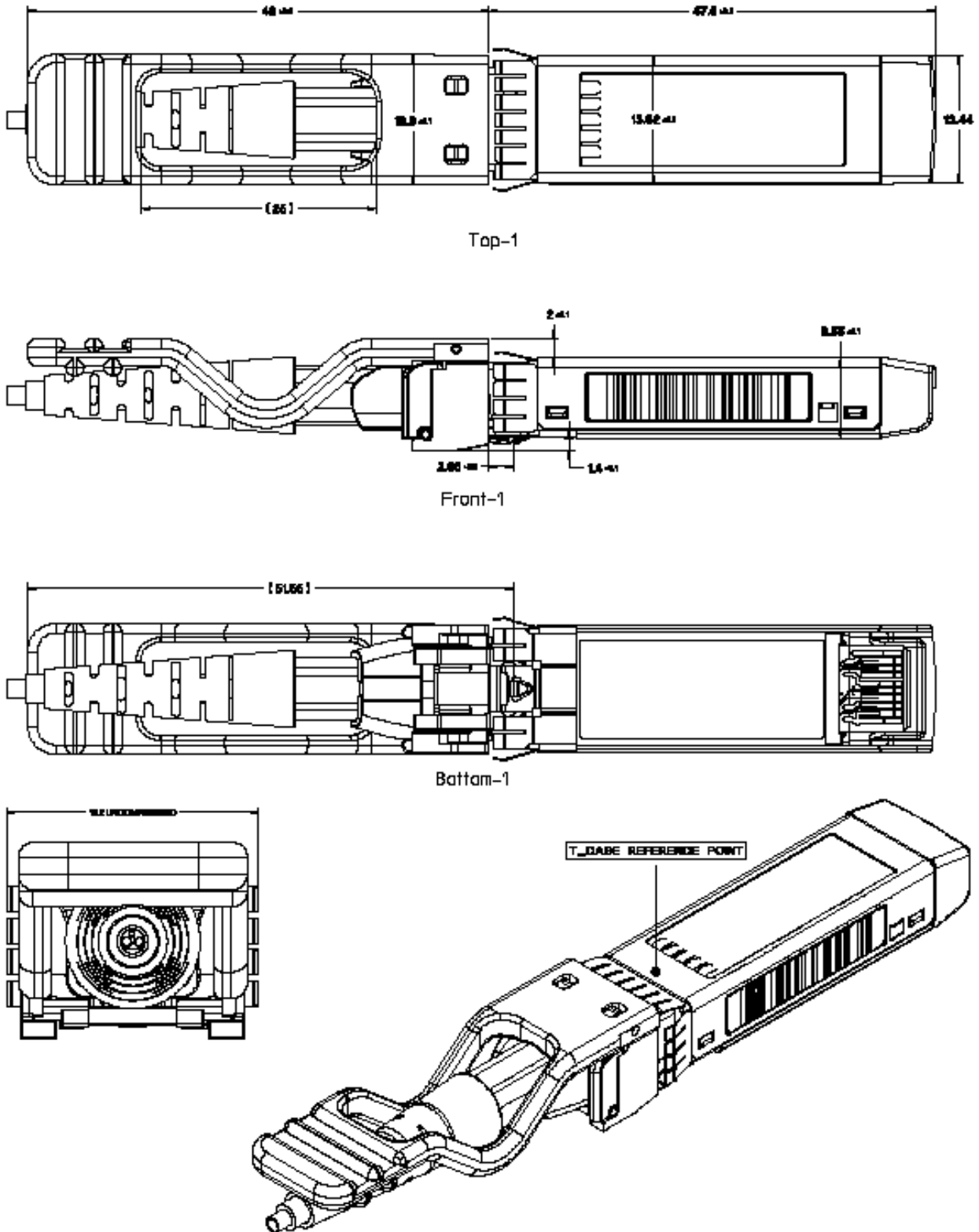

Figure 4. Module drawing

Measurement	Minimum	Maximum	Units	Comments
Insertion	0	18	N	
Extraction	0	12.5	N	
Retention	90	170	N	No functional damage to device below 90N

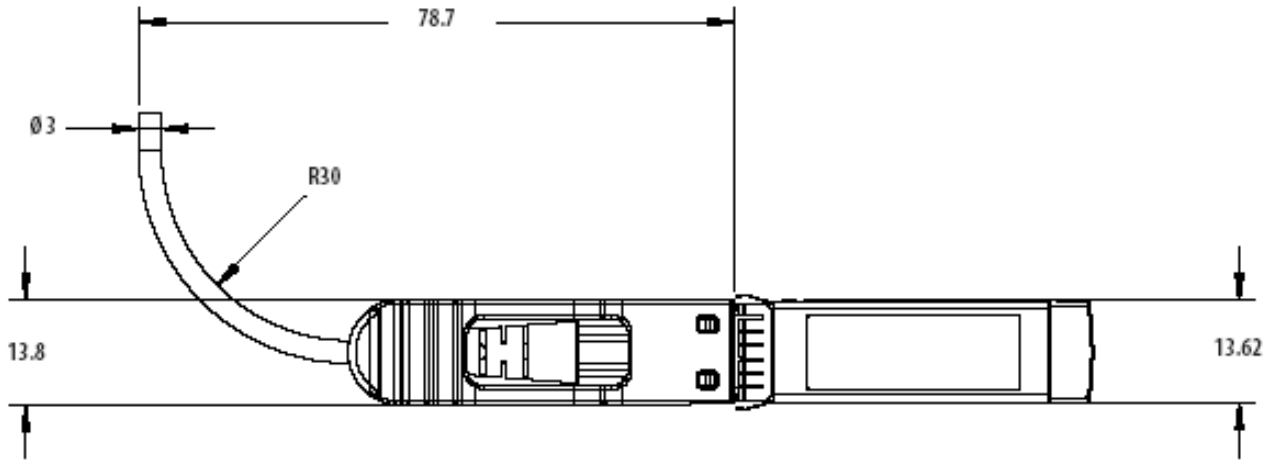

Figure 5. Bend Radius Definition

Table 10. SFP+ AOC Cable Assembly Length Tolerances

Length	Cable Length Tolerance
1 m	+20/-0 cm
2 m	+20/-0 cm
3 m	+20/-0 cm
5 m	+20/-0 cm
7 m	+20/-0 cm
10 m	+20/-0 cm
15 m	+2%/-0 cm
20 m	+2%/-0 cm

Note:

Cable Length is defined as the length of the fiber only (not including the SFP+ module-ends).

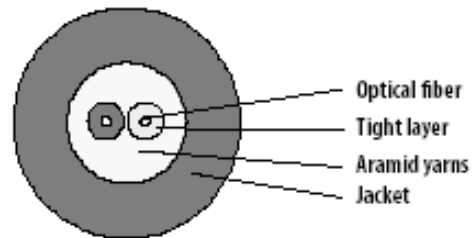

Figure 6. Optical fiber details

Table 11. Optical Fiber Specifications

Parameter	Specification
Tight buffer color	orange, yellow
Tight buffer material	PVC
Tight buffer diameter mm	0.60 ± 0.05
Fiber type	62.5/125 (OFS) Bandwith:160 MHz.KM @ 850 nm
Strength member	Aramid yarns
Jacket color	Orange
Jacket material	PVC
Cable diameter mm	3.0 ± 0.1
Cable weight Kg/km	7.0
Min. bending radius mm	30
Attenuation dB/km	≤ 3.5 at 850 nm ≤ 1.5 at 1300 nm
Short tension N	120
Short crush N/100mm	500
Operation temperature °C	-20~70