

IGBT MODULE (S series) 600V / 100A / PIM



■ Features

- Low $V_{CE(sat)}$
- Compact package
- P.C. board mount
- Converter diode bridge, Dynamic brake circuit

■ Applications

- Inverter for motor drive
- AC and DC servo drive amplifier
- Uninterruptible power supply

■ Maximum ratings and characteristics

● Absolute maximum ratings ($T_c=25^{\circ}\text{C}$ unless without specified)

| Item | Symbol | Condition | Rating | Unit | |
|---|---------------------------------|---------------|----------------------------------|--------------------|----------------------|
| Inverter | Collector-Emitter voltage | V_{CES} | 600 | V | |
| | Gate-Emitter voltage | V_{GES} | ± 20 | V | |
| | Collector current | I_C | Continuous | 100 | A |
| | | I_{CP} | 1ms | 200 | A |
| | | $-I_C$ | | 100 | A |
| Collector power dissipation | P_C | 1 device | 400 | W | |
| Brake | Collector-Emitter voltage | V_{CES} | 600 | V | |
| | Gate-Emitter voltage | V_{GES} | ± 20 | V | |
| | Collector current | I_C | Continuous | 50 | A |
| | | I_{CP} | 1ms | 100 | A |
| | Collector power dissipation | P_C | 1 device | 200 | W |
| Converter | Repetitive peak reverse voltage | V_{RRM} | 600 | V | |
| | Repetitive peak reverse voltage | V_{RRM} | 800 | V | |
| | Average output current | I_O | 50Hz/60Hz sine wave | 100 | A |
| | Surge current (Non-Repetitive) | I_{FSM} | $T_j=150^{\circ}\text{C}$, 10ms | 700 | A |
| | I^2t (Non-Repetitive) | I^2t | half sine wave | 2450 | A^2s |
| Operating junction temperature | T_j | | +150 | $^{\circ}\text{C}$ | |
| Storage temperature | T_{stg} | | -40 to +125 | $^{\circ}\text{C}$ | |
| Isolation between terminal and copper base *2 voltage between thermistor and others *3 | V_{iso} | AC : 1 minute | AC 2500 | V | |
| | | | AC 2500 | V | |
| Mounting screw torque | | | 3.5 *1 | N·m | |

*1 Recommendable value : 2.5 to 3.5 N·m (M5)

*2 All terminals should be connected together when isolation test will be done.

*3 Terminal 8 and 9 should be connected together. Terminal 1 to 7 and 10 to 24 should be connected together and shorted to copper base.

● Electrical characteristics (Tj=25°C unless otherwise specified)

| Item | Symbol | Condition | Characteristics | | | Unit | | |
|------------------------------|--------------------------------------|--------------------|-------------------------|----------|-------|------|------|-----|
| | | | Min. | Typ. | Max. | | | |
| Inverter | Zero gate voltage collector current | ICES | VCE=600V, VGE=0V | | 1.0 | mA | | |
| | Gate-Emitter leakage current | IGES | VCE=0V, VGE=±20V | | 0.2 | µA | | |
| | Gate-Emitter threshold voltage | VGE(th) | VCE=20V, Ic=100mA | | 5.5 | 7.8 | 8.5 | V |
| | Collector-Emitter saturation voltage | VCE(sat) | VGE=15V, Ic=100A | chip | 1.8 | | V | |
| | | | | terminal | 2.15 | 2.6 | | |
| | Input capacitance | Cies | VGE=0V, VCE=10V, f=1MHz | | 10000 | | pF | |
| | Turn-on time | ton | VCC=300V | | 0.45 | 1.2 | µs | |
| | | tr | Ic=100A | | 0.25 | 0.6 | | |
| | | tr(i) | VGE=±15V | | 0.08 | | | |
| | Turn-off | toff | RG=24Ω | | 0.40 | 1.0 | | |
| tf | | | | 0.05 | 0.35 | | | |
| Forward on voltage | VF | IF=100A | chip | 1.6 | | V | | |
| | | | terminal | 1.95 | 2.7 | | | |
| Reverse recovery time of FRD | trr | IF=100A | | | 0.3 | µs | | |
| Brake | Zero gate voltage collector current | ICES | VCEs=600V, VGE=0V | | 1.0 | mA | | |
| | Gate-Emitter leakage current | IGES | VCE=0V, VGE=±20V | | 0.2 | µA | | |
| | Collector-Emitter saturation voltage | VCE(sat) | Ic=50A, VGE=15V | chip | 1.8 | | V | |
| | | | | terminal | 2.05 | 2.5 | | |
| | Turn-on time | ton | VCC=300V | | 0.45 | 1.2 | µs | |
| | | tr | Ic=50A | | 0.25 | 0.6 | | |
| | Turn-off time | toff | VGE=±15V | | 0.40 | 1.0 | | |
| | | tf | RG=51Ω | | 0.05 | 0.35 | | |
| | Reverse current | Irrm | VR=600V | | | 1.0 | mA | |
| | Converter | Forward on voltage | VFM | IF=100A | chip | 1.1 | V | |
| terminal | | | | | 1.2 | 1.5 | | |
| Reverse current | Irrm | VR=800V | | | 1.0 | mA | | |
| Thermistor | Resistance | R | T=25°C | | 5000 | Ω | | |
| | | | T=100°C | | 465 | | 495 | 520 |
| | B value | B | T=25/50°C | | 3305 | 3375 | 3450 | K |

● Thermal resistance Characteristics

| Item | Symbol | Condition | Characteristics | | | Unit |
|---------------------------------|----------|-----------------------|-----------------|------|------|------|
| | | | Min. | Typ. | Max. | |
| Thermal resistance (1 device) | Rth(j-c) | Inverter IGBT | | | 0.31 | °C/W |
| | | Inverter FWD | | | 0.70 | |
| | | Brake IGBT | | | 0.63 | |
| | | Converter Diode | | | 0.47 | |
| Contact thermal resistance * | Rth(c-f) | With thermal compound | | 0.05 | | |

* This is the value which is defined mounting on the additional cooling fin with thermal compound

■ Equivalent Circuit Schematic

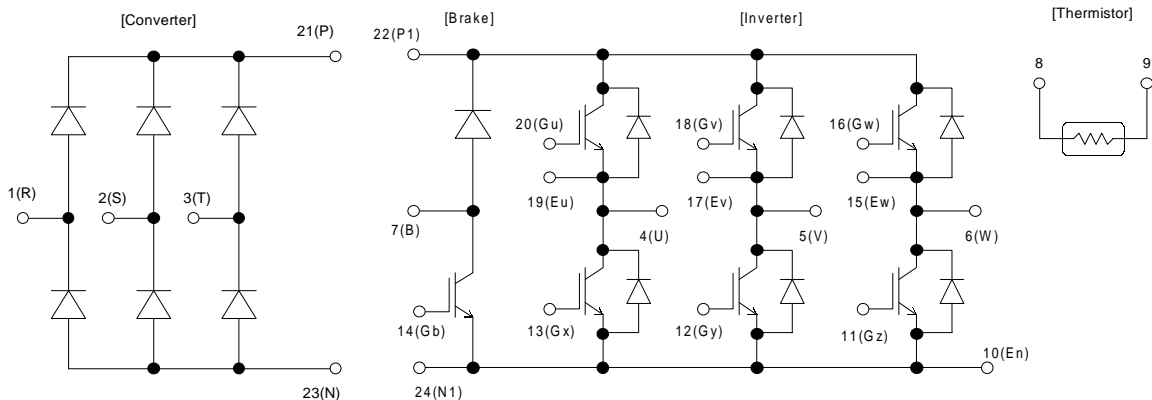

■ Characteristics (Representative)

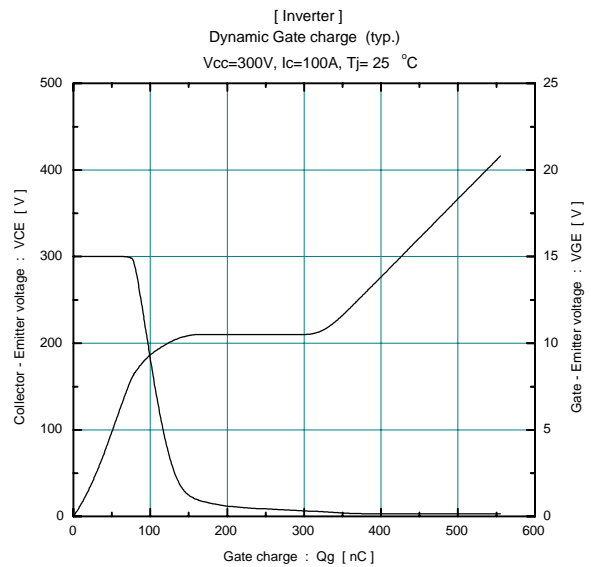
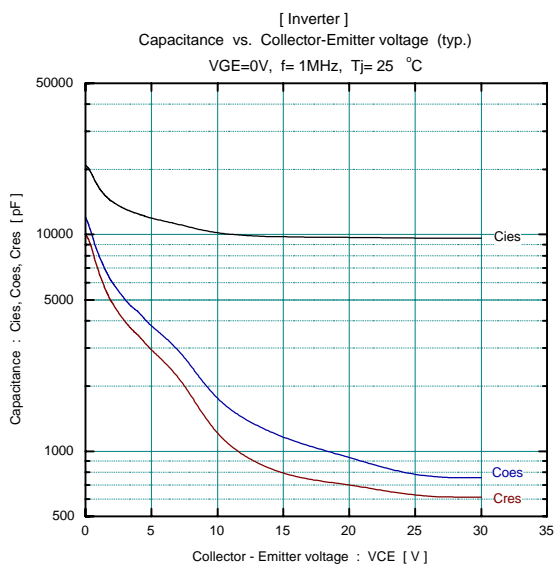
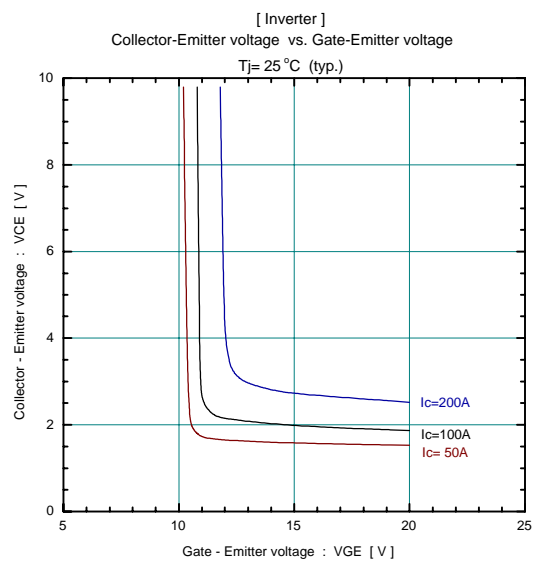
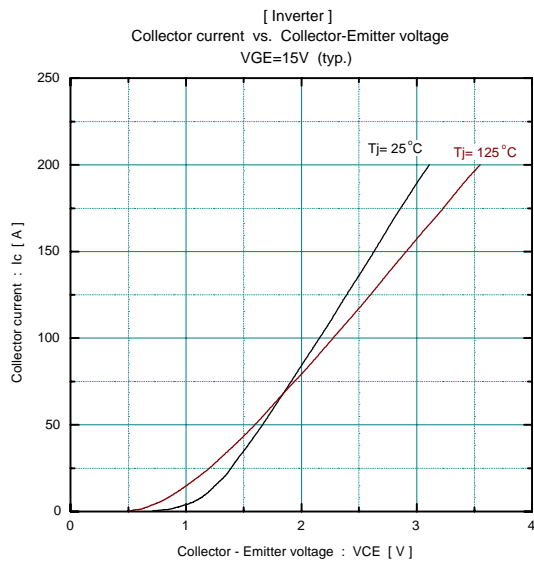
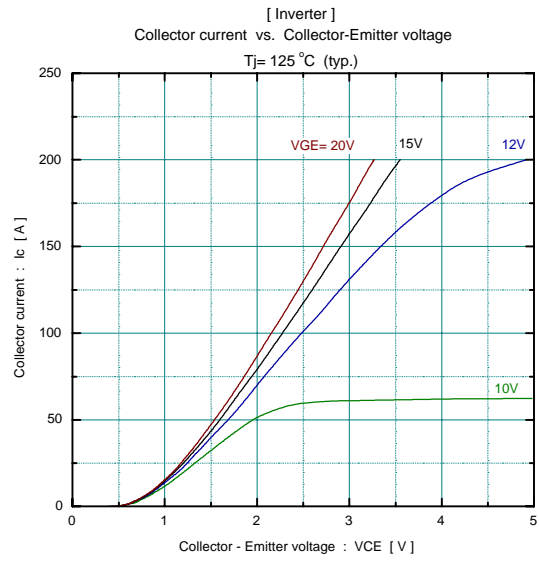
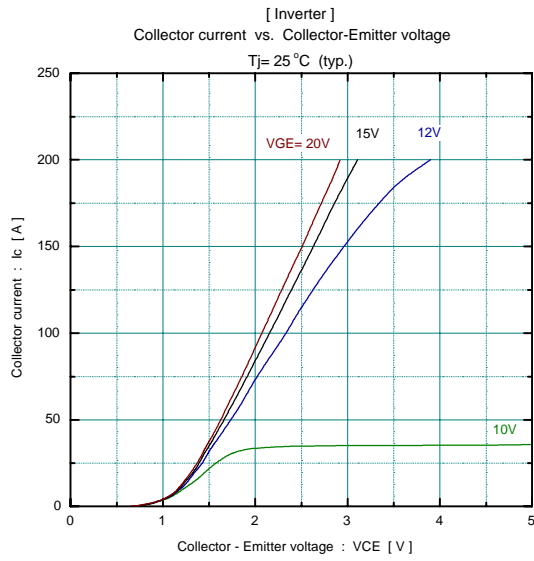

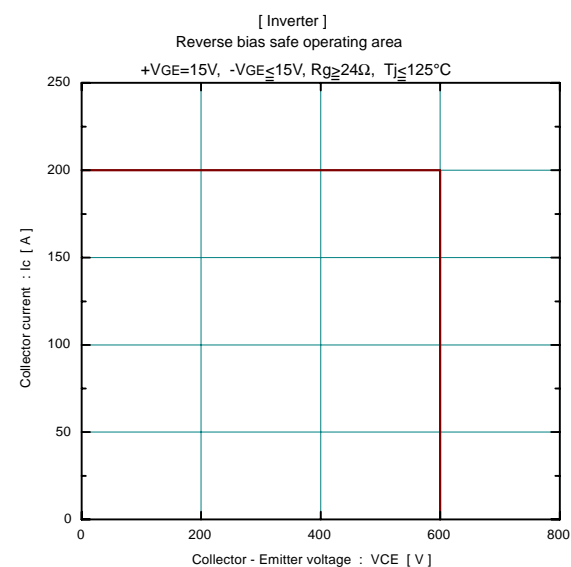
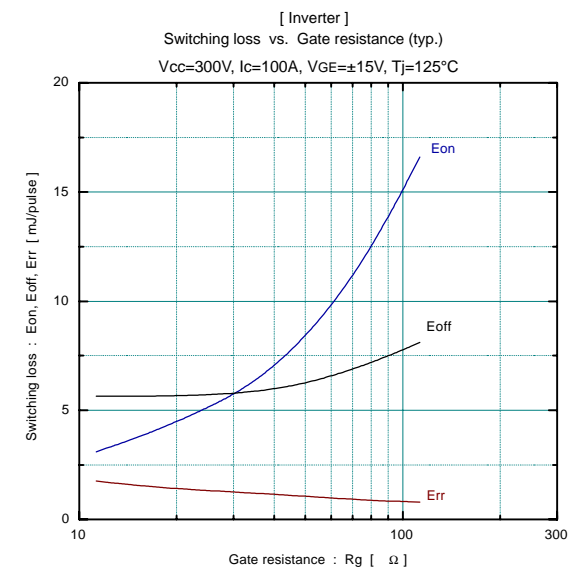
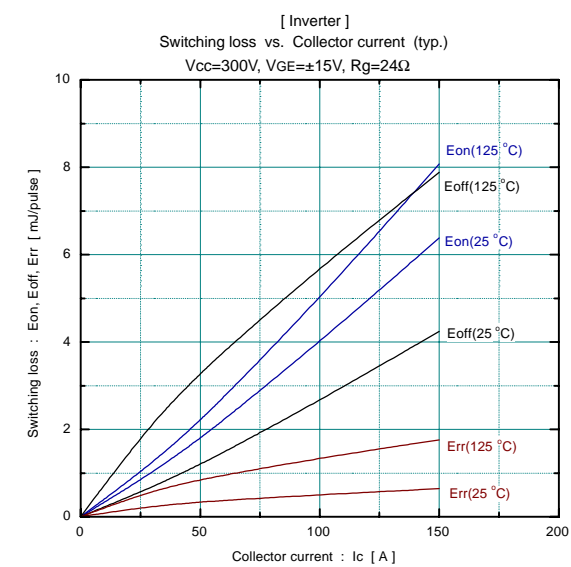
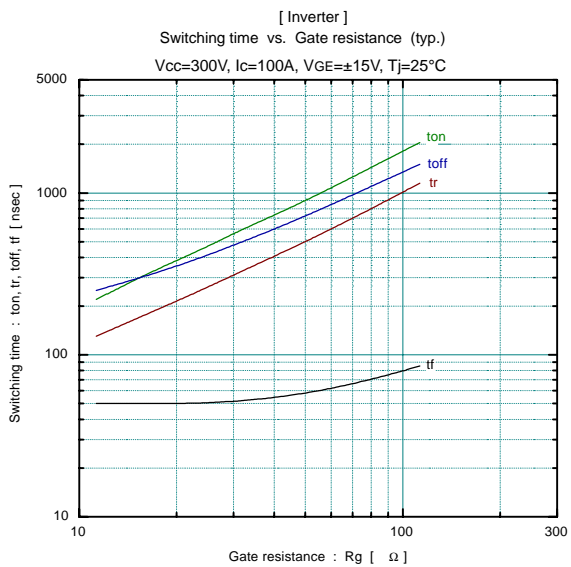
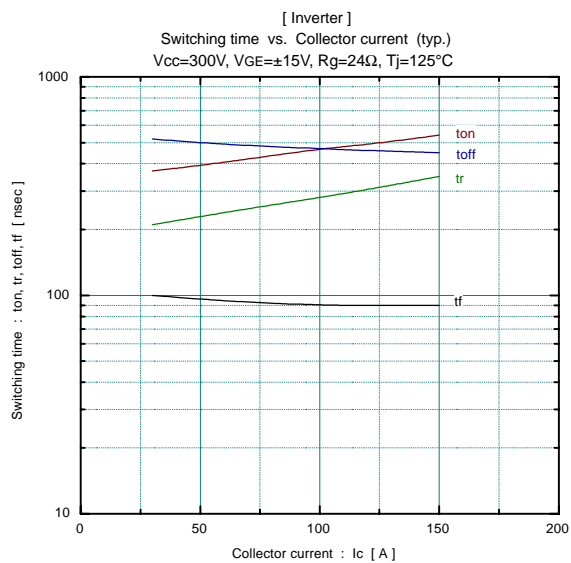
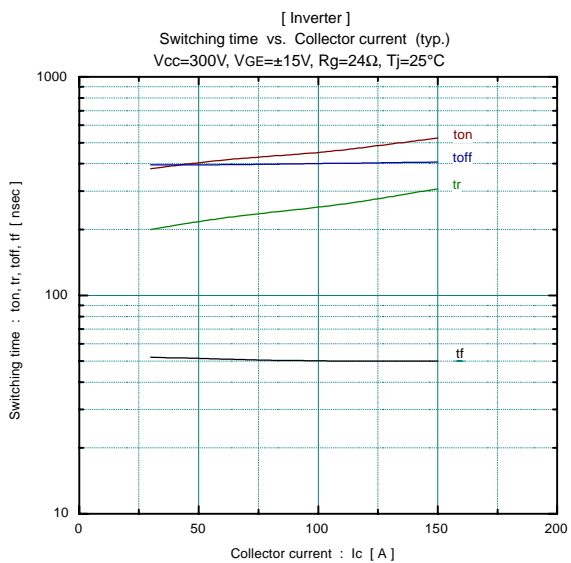

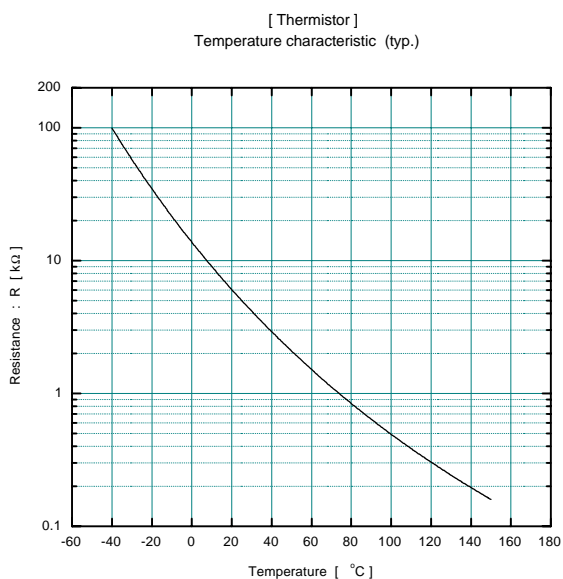
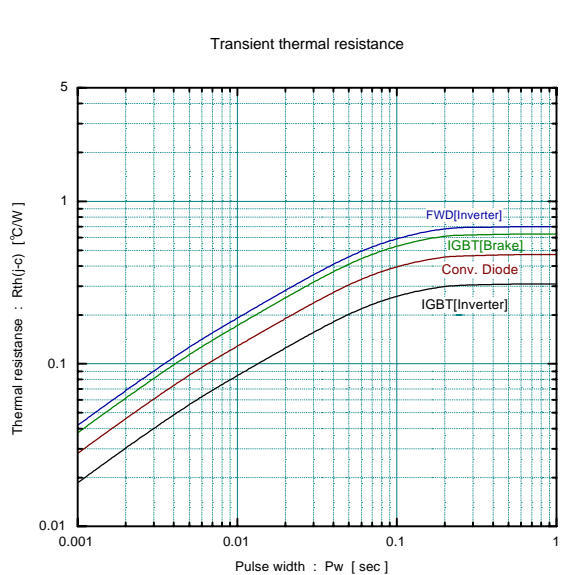
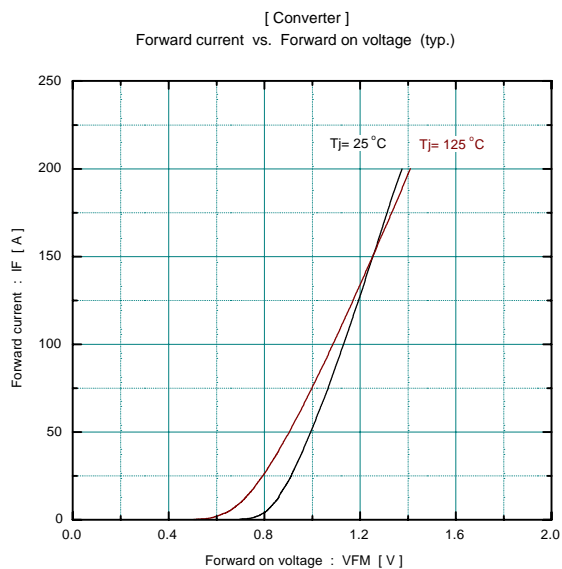
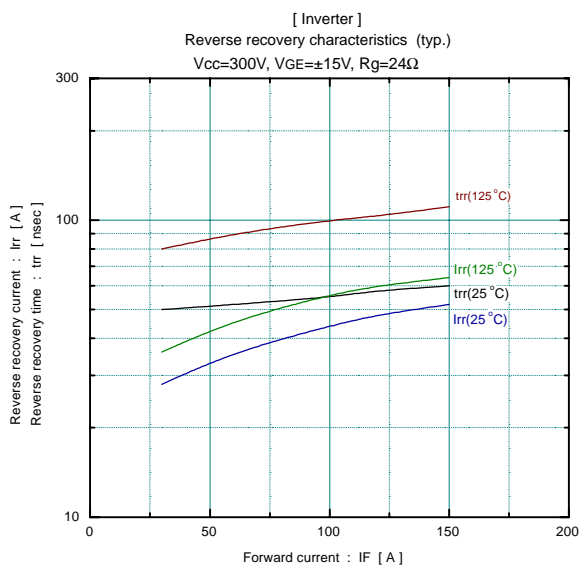
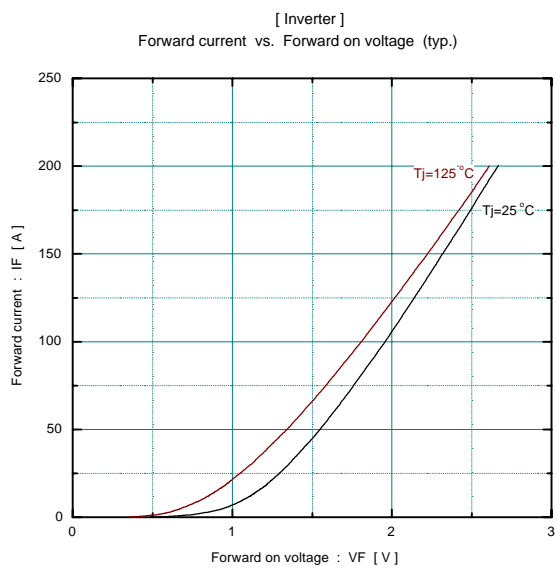

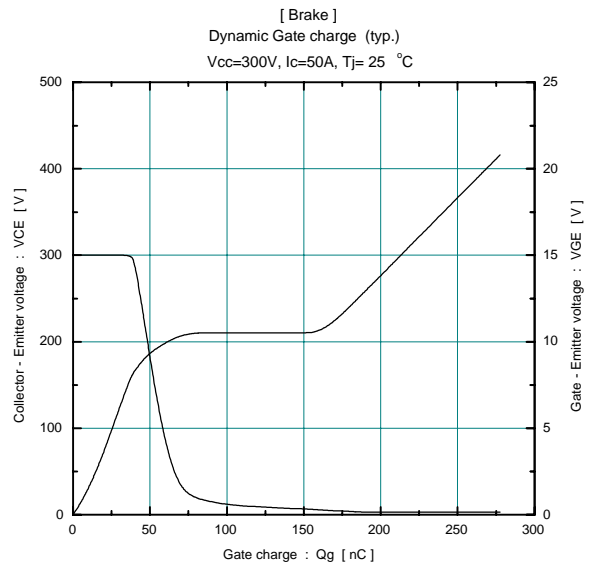
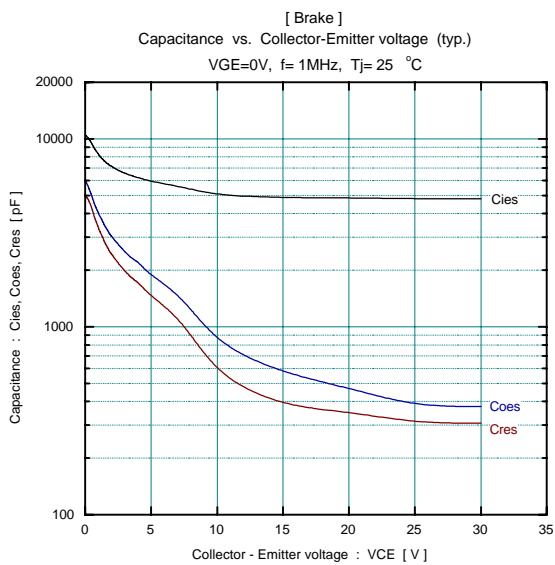
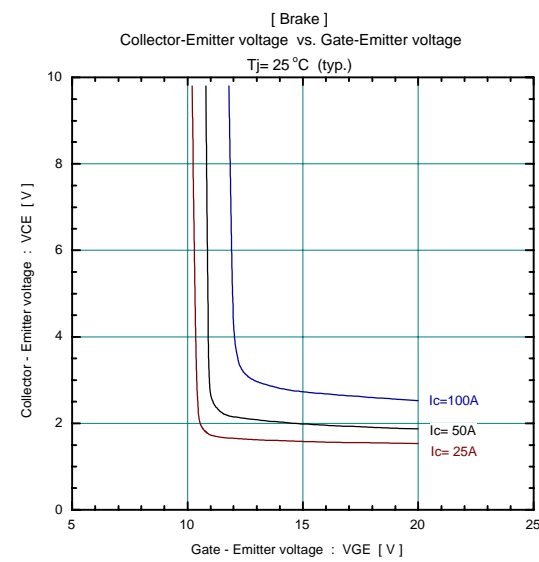
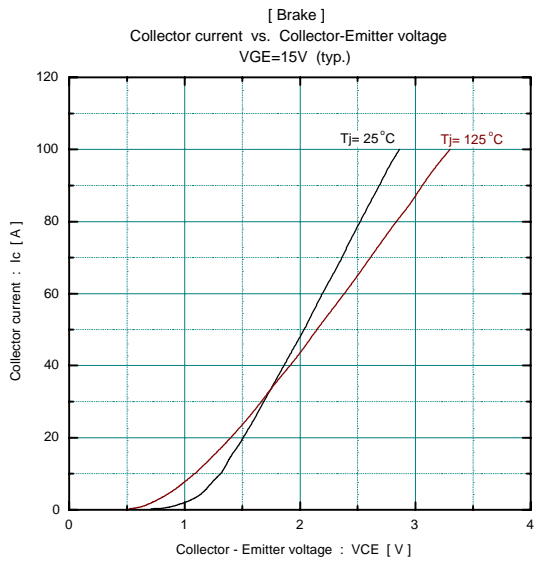
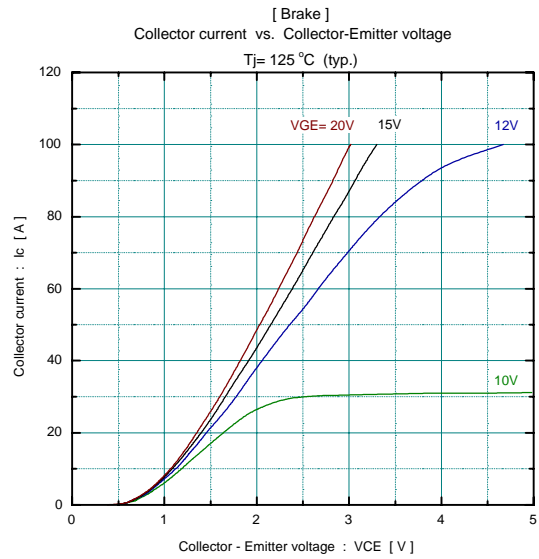
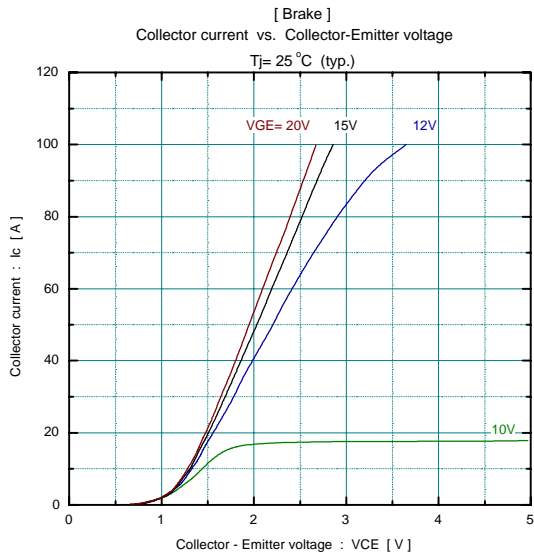

■ Outline Drawings, mm

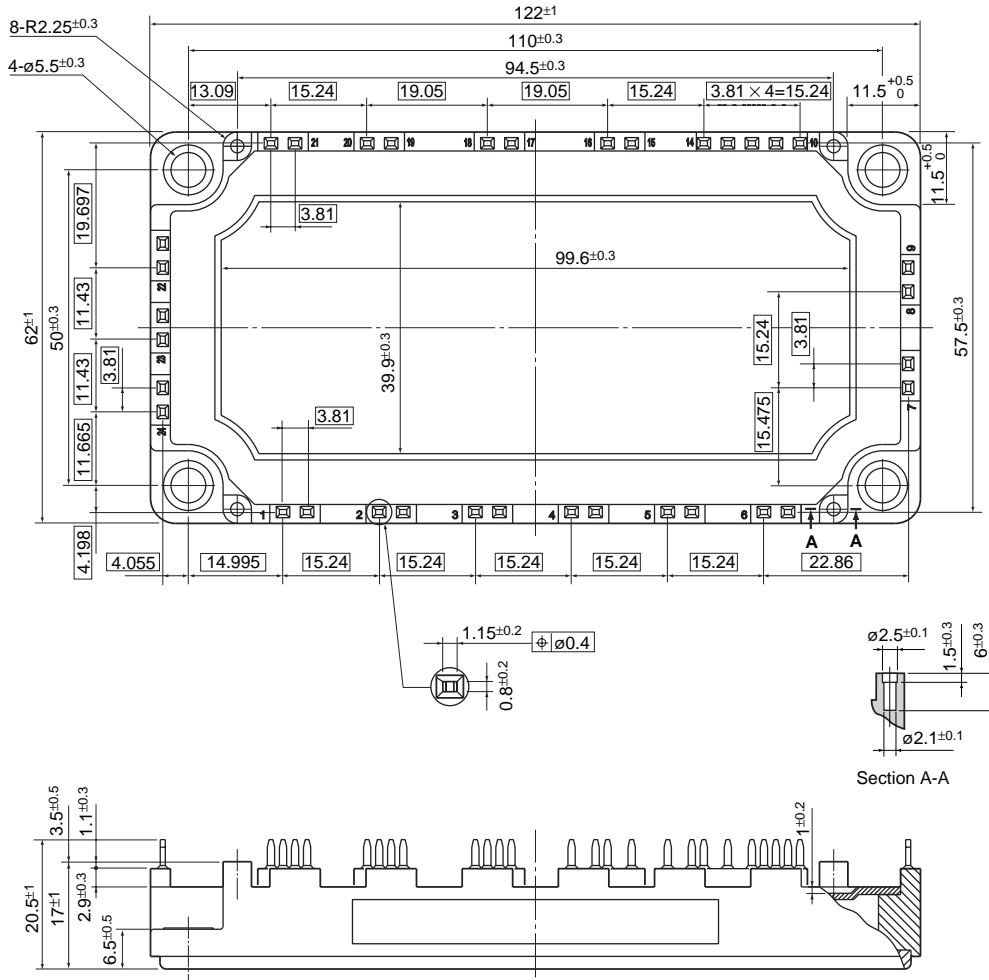

□ Shows theory dimensions