MARINE

Drives for electrically driven marine offshore winches and hoists



ACS880 Offshore Control Program +N5800 (Smart winch)

Reduced costs matter. A special purpose electric drive for winch and hoist applications.

Integrated controls built inside the ACS880 industrial drives:

- AHC (Active Heave Compensation) for LARS (Launch And Recovery System), and oceanographic for deep sea operations
- Tug escort mode using auto payout and haul, and tug push mode using constant tension
- Rope line length and speed measurement with control
- Rope line force (tension) and payout measurement with control, and Tether control for ROV (Remote Operated Vehicle) cables by maintaining constant tension that includes inertia and friction compensation



Active heave compensation

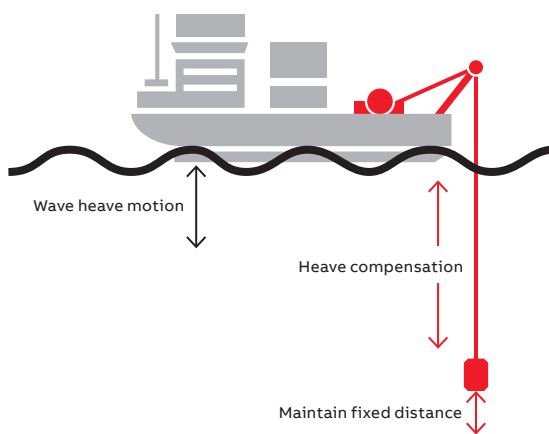

Towing for tugboats

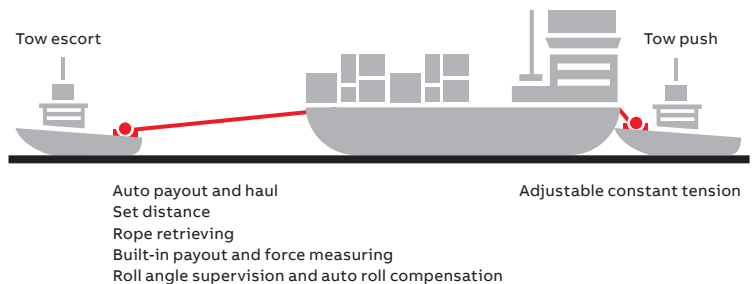

The all-compatible ACS880 industrial drive series

One platform for multiple applications in offshore winches and hoists

ELECTRICAL BRAKING OPTIONS

Dynamic Braking

(ACS880 single drives)

- Brake chopper on DC Bus where power is dumped into brake resistor

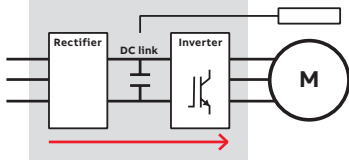

Regenerative Braking

(ACS880 single drives)

- Active Front End (AFE) where power is regenerated back to supply

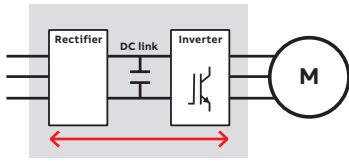

Regenerative Braking

(ACS880 multidrives)

- Multidrive configuration with supply unit, DC bus and multiple inverters

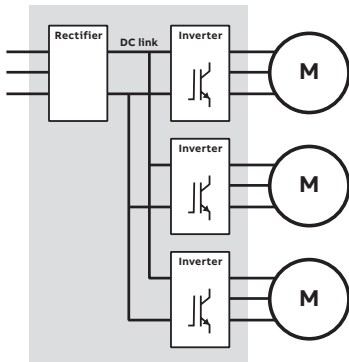

OPERATING PRINCIPAL

- Operation of the marine offshore application is based on the principle that the electric winch motor is always active during all processes of load winding, unwinding and the holding position. The mechanical brake is only used as a failsafe option or when the electric winch motor is not active.
- The system actively calculates the drum turns and diameter from the encoder signals based on application-based data. This information is then used to calculate the accurate length of rope. The same information is used to calculate force (tension) on the rope, taking into account forces due to friction, mass inertia of the motor rotor, gearing, drum, and the real time mass of the existing rope on the drum.

COMPACT AND COST EFFECTIVE DESIGN

Control algorithm built-in drive hardware

- The system has the control algorithm embedded in the ACS880 drive resulting in a compact and cost effective system.

Rope force (tension) measure built-in

- The system uses ABB DTC (Direct Torque Control™) technology for accurate motor torque to work out the accurate force (tension) on the rope, including friction and inertia compensation.

Rope length (scope) and speed measure built-in

- The system computes the drum effective layer and radius to work out the rope length and speed.

COMMON HARDWARE

- The ACS880 all-compatible platform is used for all applications resulting in a common platform for setup, troubleshooting, and maintenance.
- Fulfills marine and offshore requirements, and the design and operation comply with regulations from all major classification societies, including ABS, BV, CCS, ClassNK, DNV GL, KRS, Lloyd's Register, RINA and RMRS. You can download the marine type approval certificates issued for ACS880 drives from our website: new.abb.com/drives/segments/marine/marine-type-approvals



ACS880 wall-mounted drives
IP21 (also available as IP55)
0.75 to 250 kW



ACS880 drive modules
IP00 or IP20 for cabinet design
55 to 710 kW



ACS880 cabinet-built drives
(air-cooled or liquid-cooled)
IP54 or IP55, 55 to 2800 kW



Removable memory unit
including all software

Dedicated built-in offshore winch functionalities to minimize your engineering time

Overview of a typical winch drum and drive

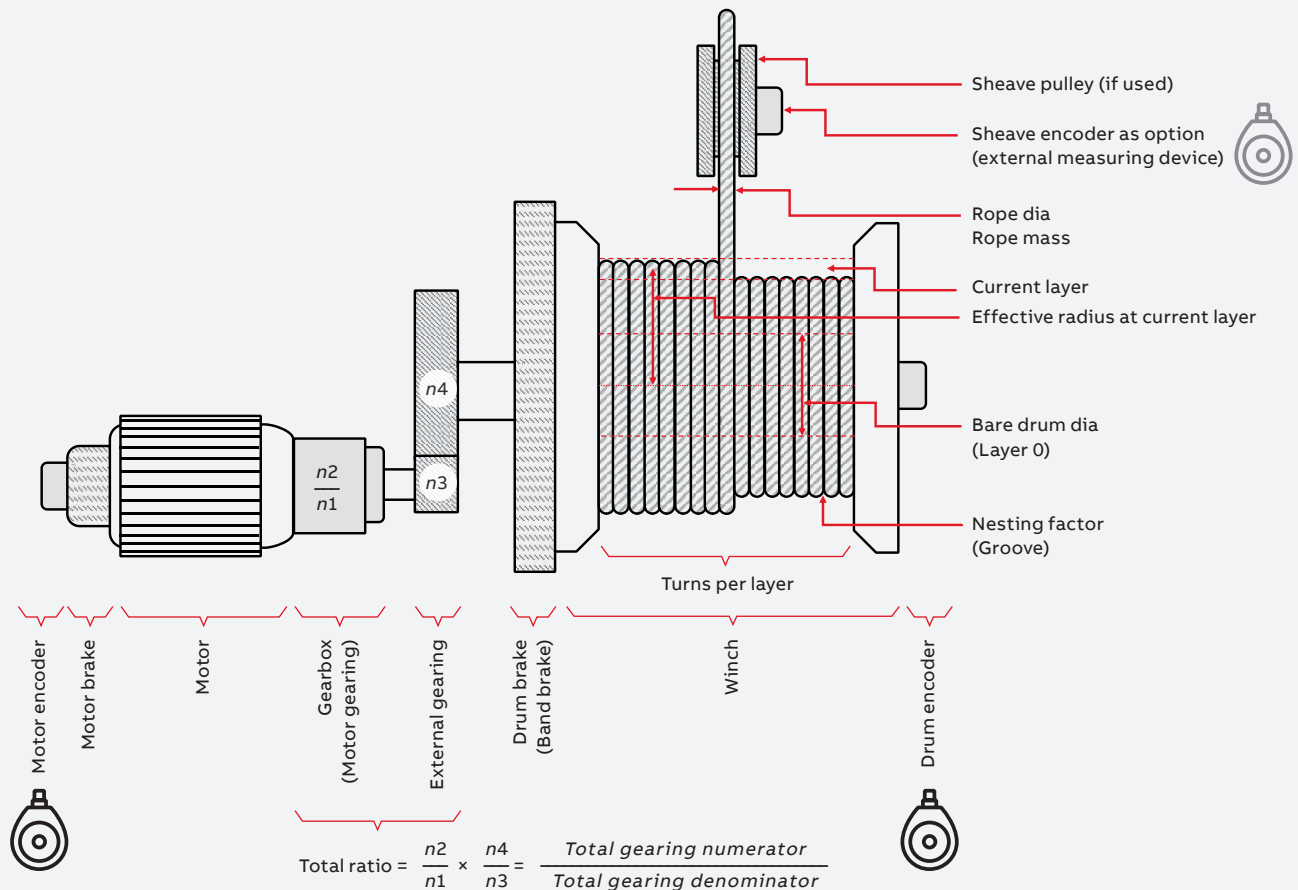

Encoder on motor or drum shaft



The encoder can be mounted on a motor shaft or a winch drum shaft, and the system automatically configures the process parameters using the total gear ratio between the motor and drum shaft.

The incremental encoder must have dual channels.

The option exists for TTL or HTL type signals. The system keeps the drum turns in an internal nonvolatile memory when the power is turned off.

The absolute encoder is not necessary as the system saves drum turns in an internal nonvolatile memory when power is turned off. The absolute encoder is rarely recommended in situations where a winch may be mechanically rotated during drive power off stage and it is not feasible to carry out Reset count and Payout calibrate after power is restored to the drive.

External measuring device option



Normally payout is calculated using the encoder on the motor or drum based on drum turns, layer and effective diameter. However the smart winch offers the choice of payout measure from an extra encoder mounted on an external measuring device such as a sheave pulley.

The encoder has to be incremental and the system saves the payout in an internal nonvolatile memory when power is turned off.

This option is preferred when the winch or hoist spooling is not symmetrical or nested properly, and/or higher payout accuracy is required.

MRU and Master follower

The MRU (Motion Reference Unit) has a gyro and accelerometer to sense rotational orientation and linear motion. The MRU heave amplitude signal is used as a position reference to control the AHC and the MRU roll angle signal is used for roll alert with auto roll compensation. All controls are embedded in the ACS880 drives.

MRU (Motion Reference Unit)



The Interface with MRU can be either direct via Ethernet (Modbus TCP), fieldbus communications or a 4-20 mA analog signal.

Selected MRU suppliers can provide units with inbuilt **ABB Smart Winch Protocol Modbus TCP** so that a direct Ethernet link can be made to the Smart Winch.

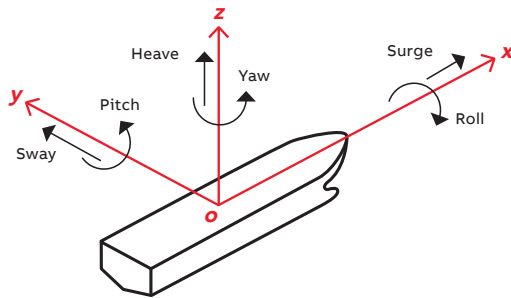

Embedded Ethernet Module (Slot 1)
Modbus TCP FENA-21 or FMBT21



Default Rate 40 ms (25 Hz)



MRU Signals

- Heave amplitude (used in AHC)
- Roll angle (used in Roll Alert/Auto roll compensation)

Scaling

- Fully scalable with offset

Remote Heave Signal

- Integrated in select MRUs or via separate control

Master/Follower

The multimotor functionality is supported for up to 10 drives. This includes one master drive and up to 9 follower drives that form a system together.

The drives in the Master/ Follower system are linked together via the built-in D2D (drive-to-drives) link.

Master/Follower Torque

The motors are connected mechanically to each other, e.g. using a winch driven by multiple motors with the same gearbox.

Master/Follower Position Synchronisation

The motors in the Master and Follower system are not mechanically connected together, e.g. multiple winches.

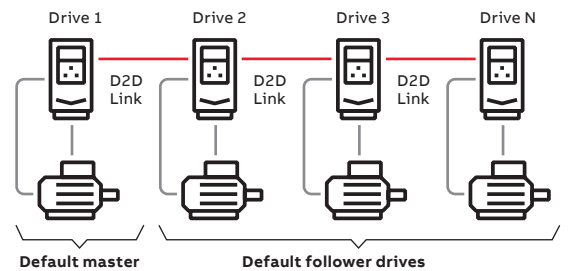

- Default follower drives**
- Option potential masters for redundancy +N5800
 - Encoder on motor or drum

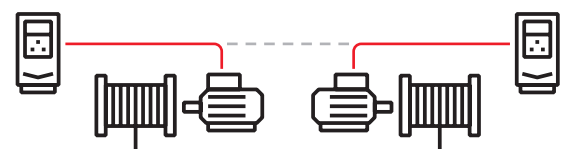
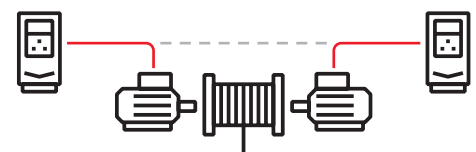

Active Heave Compensation (AHC)

Active Heave Compensation is a technology used on marine winch hoisting equipment to reduce the effect of water waves during offshore operations.

The built-in AHC software actively compensates movement change using ACS880 industrial drives as a control system measured by a MRU (motion reference unit) sensor.

The electrical winch system with ACS880 drives and motors compensate the wave movement by automatically controlling the winch in the opposite direction at the same speed.

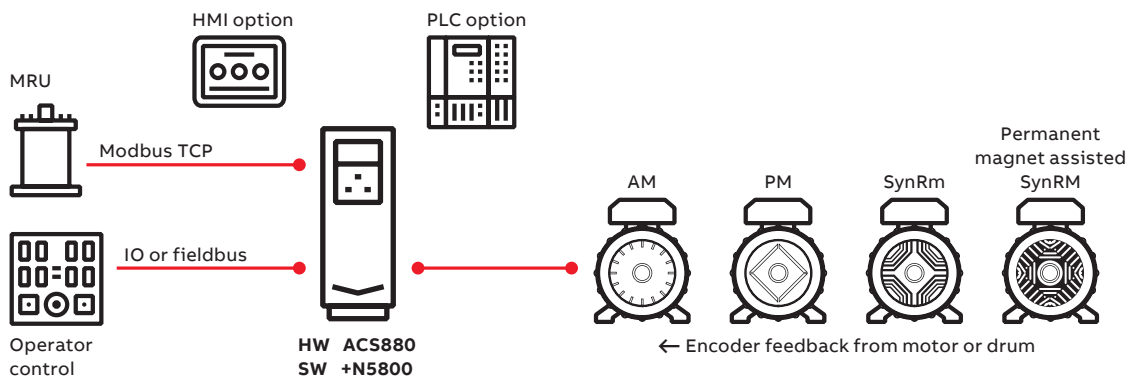
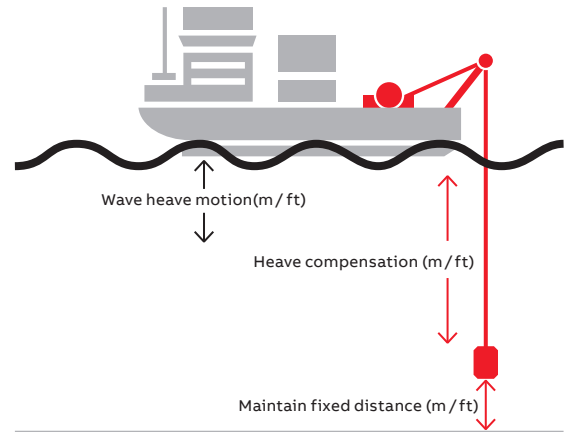

Task AHC (Active Heave Compensation) and Soft Transition

The AHC control keeps the load stable regardless of vessel motion due to sea waves can be enabled with AHC soft transition feature that allows an adjustable transition time to synchronize the winch with the MRU signal.

Task manual control/operator override

The winch operator can on the fly while running the winch change and correct the position of the load in AHC operation, typically with a joystick.

AHC reference ramp and correction limit functions

The AHC reference ramp and limit functions for safe operation when large and fast amplitude corrections occur.

AHC payout (scope) error

Payout error monitoring between commanded payout and actual payout.

Force (Tension) limit functions

The Rope Force (Tension) limit function ensures maximum line force limit, and this limit can be in terms of torque limit or actual force in kgs/pounds/tons.

True force calculation (friction and inertia compensation)

Friction and inertia compensation gives accurate force on rope.

AHC simulation

Variable amplitude and time wave simulation tests system performance without MRU variations.

Preset payout

Payout to a fixed length with minimum and maximum force limits monitoring in case line gets stuck during payout or haul. Preset payout available with or without AHC activated.

Towing for tugboats and other types of loads

Towing controls the tow of other vessels or loads that can include trawler nets and ocean sensors.

Towing – Escort

The winch acts as a brake with force limitation and tries to maintain the tow distance. The Task Tow Escort is usually initiated after the operator has set the rope length as the tow distance. The mechanical brake is disengaged.

At any time during Task Tow Escort, the operator can intervene to haul or payout the rope and the system accepts the new rope length as the set tow distance. The operator sets the maximum force limit via the force potentiometer or overriding controller.

Towing – Push

The winch maintains constant force (tension) on the rope and is always pulling the rope in wind direction with low a force set by the operator. The mechanical brake is disengaged.

The purpose of the Task Tow Push (constant tension) is to maintain a constant tension on the rope so that the rope can be wound or unwound without interfering with the operations. The operator sets the wind force limit via the force potentiometer or by overriding controller.

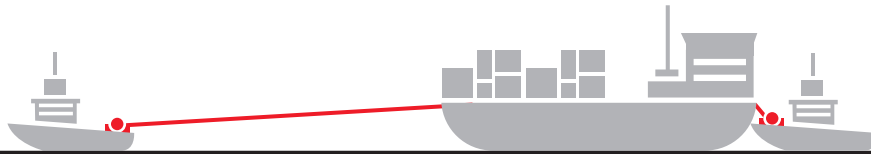

Towing winch's main task is to manage the process of towing (escorting) the load and pushing (constant tension).

Line force (Tension) limit with auto payout and Haul

When the operator set maximum line force (tension) limit is exceeded, the drive automatically lets the winch payout (render), and when the force is reduced within the operator set limit, the winch auto hauls (retrieves).

Friction and inertia compensation for force (Tension)

Friction and inertia compensation to give accurate force on the rope.

Tow distance maintenance

Constantly monitors and maintains the set tow distance whenever the rope force (tension) is within the set limits.

Slack rope prevention

When the tow load moves towards the winch with the Slack Rope feature active, then as soon as the force (tension) falls below the slack rope activation force, the winch winds to maintain the minimum set tension.

Roll alert and auto roll compensation

To mitigate vessel roll (heel) angle issues, the roll alert and auto roll compensation features can be enabled in the Smart winch if a MRU (Motion Reference Unit) is used. With Roll compensation enabled, the line force (tension) limit is automatically decreased or increased in proportion to the roll angle value.

Umbilical cable or tether winch

The umbilical winch manages the process of keeping the force (tension) on the cable constant for ROV or Subsea equipment. The built-in winch turn layer and true force calculation maintain stable tension in terms of true metric or imperial force units instead of the motor torque.

Umbilical cable winch

The winch maintains a constant force on the cable and always pulls the cable to wind with force set by the operator. The mechanical brake is disengaged.

- When the vessel heaves up the **Cable** unwinds the winch and has to provide force for system inertia and friction and hence the force or tension increases on the cable. With compensation on the drive automatically calculates the correct reduction in the motor torque necessary to compensate and maintain the set tension.
- When the vessel heaves down the **Motor** winds the winch and has to provide force for system inertia and friction and hence the force or tension decreases on the cable. With compensation on the drive automatically calculates the correct increase in the motor torque necessary to compensate and maintain the set tension.

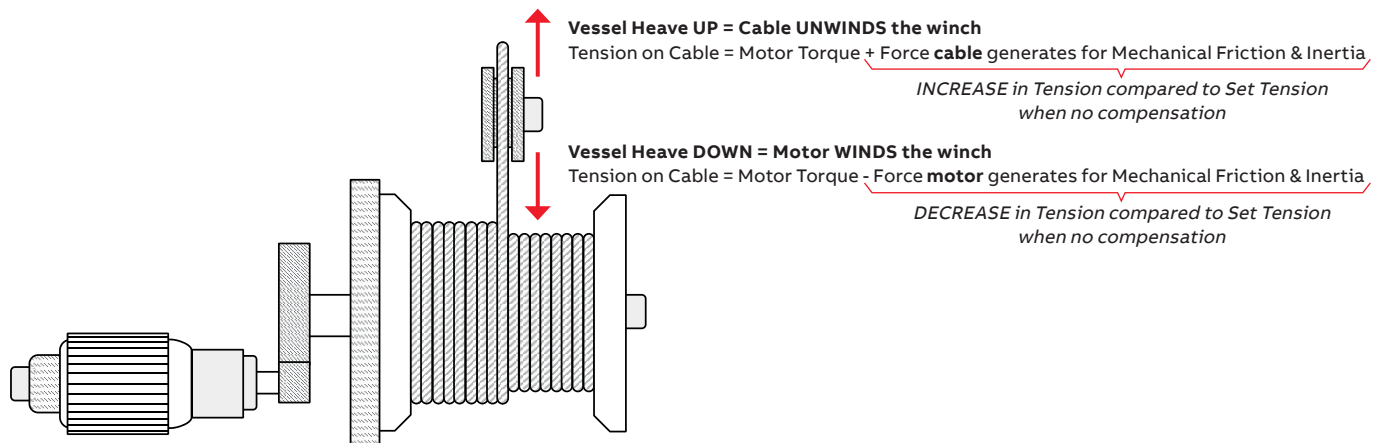

ABB's ACS880 connects to various components used to control and run the winch optimally

Connectivity

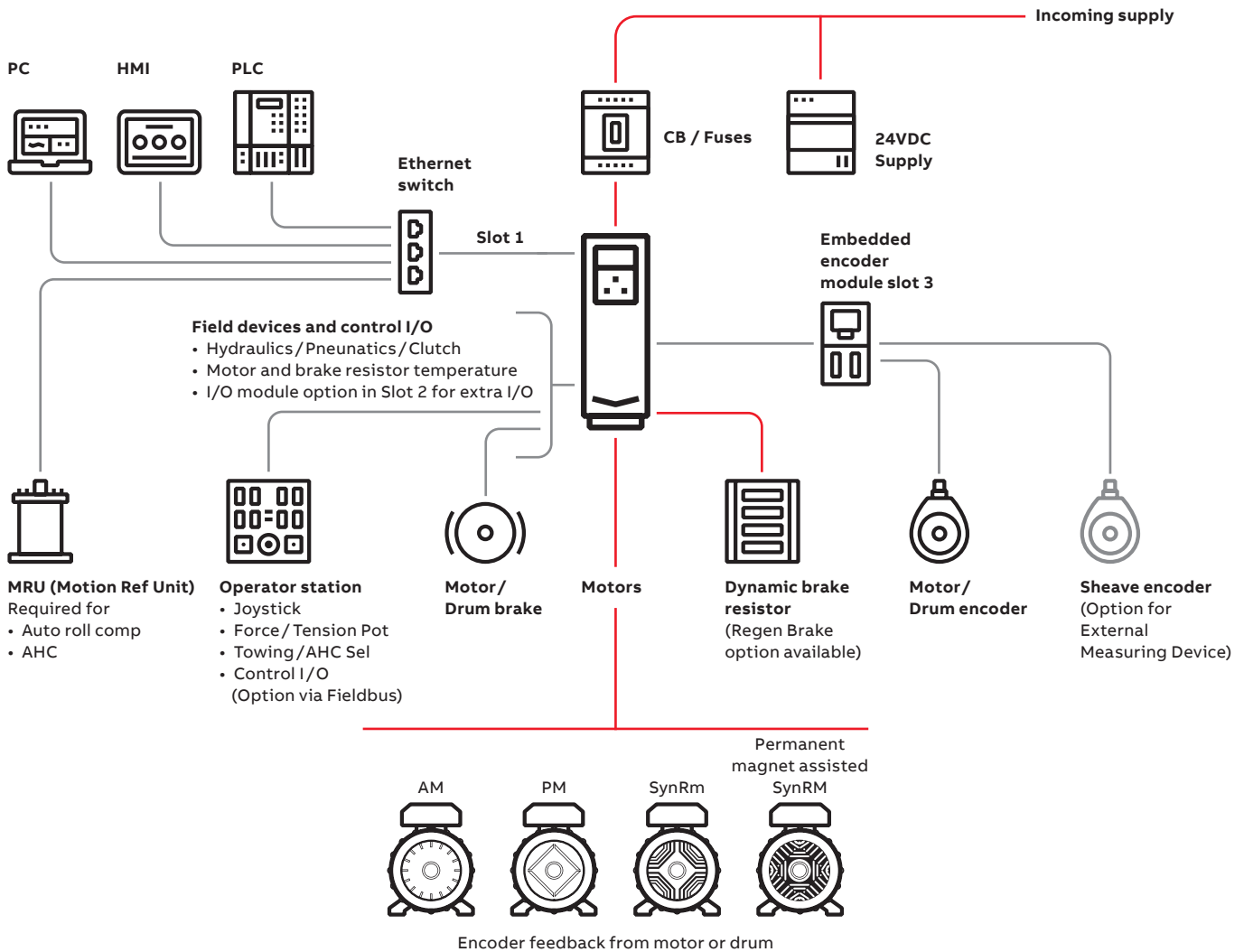

All necessary control I/O connections are embedded and can also be controlled over fieldbus

- Joystick control for manual operations
- Force (Tension) set potentiometer
- Precision speed (Reduced Speed Mode)
- Preset payout with or without AHC activated
- MRU (Motion Reference Unit) analog or fieldbus input
- Mechanical brake control and acknowledgement
- Task selection
- Motor temperature
- Feathering (light drive braking) during very fast unwind with light load to avoid birds' nest
- Brake resistor for dynamic brake with temperature input
- Field device(s) control output
- Payout calibrate and reset count for rope turns
- E Stop (STO – Safe Torque Off)
- Bypass in-built minimum wraps and length limits
- Reset fault
- Encoder(s)
- Fieldbus

PC tools

—
01
Drive Composer pro
PC tool

The **Drive Composer pro** PC tool offers a fast and harmonized setup, and commissioning and monitoring for ABB's all-compatible drives. The free version of the tool, **Drive Composer Entry**, provides startup and maintenance capabilities, and includes support for adaptive programming. It also gathers all drive information, such as parameter loggers, faults, backups and event lists, into a support diagnostics file.



—
01

The **Drive Composer pro** provides additional features, such as:

- graphical reference and control chain diagrams
- possibility to connect to several drives simultaneously over Ethernet or panel bus
- graphical interface for configuring functional safety features

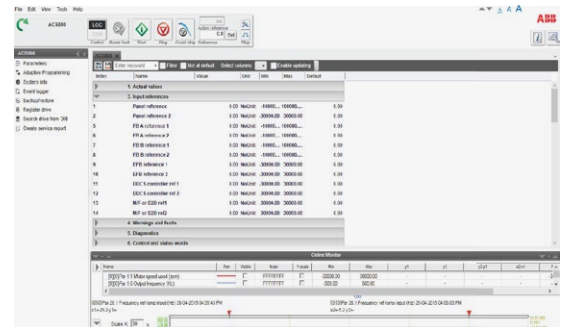





—
For more information, please contact
your local ABB representative or visit

new.abb.com/drives/segments/winches
new.abb.com/motors-generators/segments/marine