

REF 542plus

Technical Reference Manual

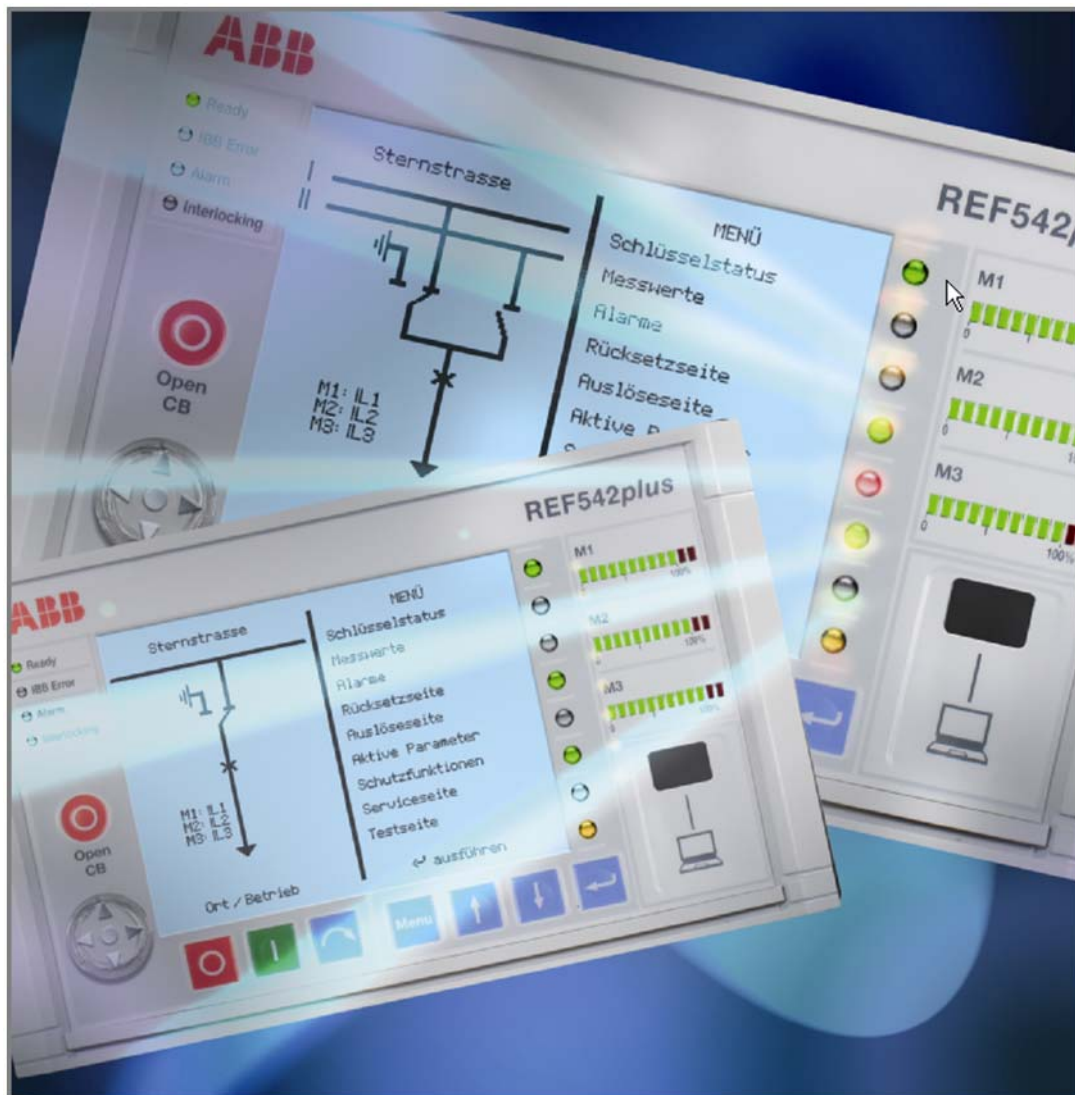

Contents

Copyrights	5
1. Introduction	7
1.1. This manual	7
1.2. Use of symbols	7
1.3. Intended audience	7
1.4. Product documentation	8
1.5. Document revisions	8
2. Safety information	9
3. General	11
4. Functions	19
4.1. Configuration	19
4.2. Measurement	19
4.2.1. Directly measured values	20
4.2.2. Calculated values	20
4.2.3. Other values	20
4.2.4. Monitoring and self-diagnosis	21
4.3. Protection	21
4.4. Control	23
4.5. Event recording	23
4.6. Fault recorder	24
4.7. Time synchronization	24
4.8. Interface to the primary process	25
4.8.1. Analog inputs	25
4.8.2. Binary inputs and outputs	27
4.9. Interfacing a station automation system	27
4.10. Embedded Web Server	28
4.11. CAN Open (only for ABB switchgear companies)	29
4.12. ABB Product Data Registration	30
5. Construction	31
5.1. Base unit versions	31
5.2. Mounting and installation	34
5.3. HMI	34
6. Technical data	37
6.1. Analog inputs	37
6.1.1. Measurements	37
6.1.2. Protection	37
6.1.3. Analog input modules	38
6.1.4. Reaction time	38
6.2. Protection functions' technical data	39

6.3.	Configuration restriction	45
6.4.	Binary inputs and outputs.....	46
6.4.1.	BIO module with mechanical output relays (version3)	46
6.4.2.	BIO module with static outputs.....	47
6.5.	Interfaces	48
6.6.	Power supply	49
6.7.	Environmental conditions	50
6.8.	Protection degree	50
6.9.	Tests	50
7.	Ordering.....	53
8.	Connections	61
8.1.	Connector plates	61
8.2.	Binary input and output connections	65
8.3.	Typical connection schemes	67
8.3.1.	Generic outgoing feeder.....	67
8.3.2.	Feeder with differential protection	68
8.3.3.	Incoming feeder with synchrocheck.....	69
9.	Abbreviations	71

Copyrights

The information in this document is subject to change without notice and should not be construed as a commitment by ABB Oy. ABB Oy assumes no responsibility for any errors that may appear in this document.

In no event shall ABB Oy be liable for direct, indirect, special, incidental or consequential damages of any nature or kind arising from the use of this document, nor shall ABB Oy be liable for incidental or consequential damages arising from the use of any software or hardware described in this document.

This document and parts thereof must not be reproduced or copied without written permission from ABB Oy, and the contents thereof must not be imparted to a third party nor used for any unauthorized purpose.

The software or hardware described in this document is furnished under a license and may be used, copied or disclosed only in accordance with the terms of such license.

© Copyright 2010 ABB Oy

All rights reserved.

Trademarks

ABB is a registered trademark of ABB Group. All other brand or product names mentioned in this document may be trademarks or registered trademarks of their respective holders.

Guarantee

Please inquire about the terms of guarantee from your nearest ABB representative.

1. Introduction

1.1. This manual

This manual provides thorough information on the protection relay REF 542plus and its applications, focusing on giving a technical description of the relay.

1.2. Use of symbols

This publication includes the following icons that point out safety-related conditions or other important information:



The electrical warning icon indicates the presence of a hazard which could result in electrical shock.



The warning icon indicates the presence of a hazard which could result in personal injury.



The caution icon indicates important information or warning related to the concept discussed in the text. It might indicate the presence of a hazard which could result in corruption of software or damage to equipment or property.



The information icon alerts the reader to relevant facts and conditions.

Although warning hazards are related to personal injury, it should be understood that operation of damaged equipment could, under certain operational conditions, result in degraded process performance leading to personal injury or death. Therefore, comply fully with all warning and caution notices.

1.3. Intended audience

This manual is intended for operators and engineers to support normal use of as well as configuration of the product.

1.4. Product documentation

Name of the Manual	Document ID
Real Time Clock Synchronization, IRIG-B Input Time Master	1MRS755870
Product Guide	1MRS756269
Configuration Manual	1MRS755871
iButton Programmer User Manual	1MRS755863
Manual Part 3, Installation and Commission	1 VTA100004
Manual Part 4, Communication	1VTA100005
Motor Protection with ATEX Certification, Manual	1MRS755862
SCL Tool Configuration Manual	1MRS756342
Protection Manual	1MRS755860
Technical Reference Manual	1MRS755859
Technical Reference Modbus RTU	1MRS755868
Web Manual, Installation	1MRS755865
Web Manual, Operation	1MRS755864
IEC 61850 PIXIT	1MRS756360
IEC 61850 Conformance Statement	1MRS756361
IEC61850 TISSUES Conformance Statement	1MRS756362
Lifecycle Service Tool	1MRS756725

1.5. Document revisions

Version	IED Revision number	Date	History
1VTA100001- Rev 6, en	Release 1.1, software version V4C01	25.10.2002	
1VTA100001- Rev 7, en	Release 2.0, software version V4D02	15.09.2003	
A	Release 2.0 Service Pack3	28.02.2006	Document updated • language • layout
B	2.5	30.09.2006	Updated to software version V4E03x.
C	2.5	30.04.2007	Updated to software version V4E04x.
D	2.5	15.08.2007	Document updated
E	2.5	28.09.2007	Document updated
F	2.5	14.02.2008	Document updated
G	2.6	23.10.2008	Updated to software version V4F06x
H	2.6	01.07.2009	Document updated
K	3.0	10.02.2010	Updated to software version V4F08x.

Applicability

This manual is applicable to the REF 542plus Release 3.0, software version V4F08x.

2. Safety information



Dangerous voltages can occur on the connectors, even though the auxiliary voltage has been disconnected.

Non-observance can result in death, personal injury or substantial property damage.

Only a competent electrician is allowed to carry out the electrical installation.

National and local electrical safety regulations must always be followed.

The frame of the device has to be carefully earthed.



The device contains components which are sensitive to electrostatic discharge. Unnecessary touching of electronic components must therefore be avoided.

3. General

REF 542plus is a Switchgear Multifunction Protection and Switchgear Control Unit and it is the further development of the former REF 542 multifunctional unit. Like its predecessor, it features the following functions:

- Protection
- Measurement
- Control
- Monitoring and self diagnosis
- Communication

All above-mentioned and also power quality functions are integrated into a programmable environment. The exceptional flexibility and scalability of this new generation device lead to a smart solution where the traditional approach would be ineffective and expensive.

The following figures Fig. 3.-1 and Fig. 3.-2 show examples of the REF 542plus installation in several switchgears.



A050395

Fig. 3.-1 REF 542plus installed in gas-insulated switchgear (GIS)



A070118

Fig. 3.-2 REF 542plus installed in an air-insulated switchgear (AIS)

REF 542plus is composed of two parts: a base unit and a separate human machine interface (HMI). The base unit contains the power supply, the processor board, the analog input board and binary input and output (I/O) modules, as well as optional modules for supplementary functions. The base unit and a HMI are connected with a serial cable.

The HMI is a stand-alone unit with its own power supply. It can be installed on the low voltage (LV) compartment door or in a dedicated compartment close to the central unit. The HMI can be used to set the protection parameters to locally operate the switching devices in the switchgear and to visualize events and measurements. A shielded, isolated twisted pair according to the RS-485 standard interface connects the HMI to the base unit. Fig. 3.-4 shows an installation of the central unit and the HMI Control Unit in the LV compartment of a switchboard for the switchgear.



A070117

Fig. 3.-3 Mounting of the central unit in the LV compartment and the HMI on the door

REF 542plus is a real-time system. A digital signal processor (DSP) carries out the measurement and protection functions, and a micro controller (MC) the control functions. Due to the task separation, there is no impact between the implemented protection scheme and the control scheme to be modified. An optional communication processor (CP) is needed when connecting to a station automation system. A block diagram of the REF 542plus is shown in Fig. 3.-4.

The main module is equipped with the DSP and the MC. The CAN Open interface, the Ethernet interface for the embedded Web server, the optical input port for time synchronization are located on the main module as well. The optional communication module takes care of the communication with the substation automation system. The binary input and output modules interface the primary process to send commands and to acquire status information. The analog input module acquires the current and voltage signals, both from instrument transformers or non-inductive sensors. The optional analog 0/4 ... 20 mA output module and analog 4 ... 20 mA input module allow exchanging information with the 4 ... 20 mA or 0 ... 20 mA current loop.

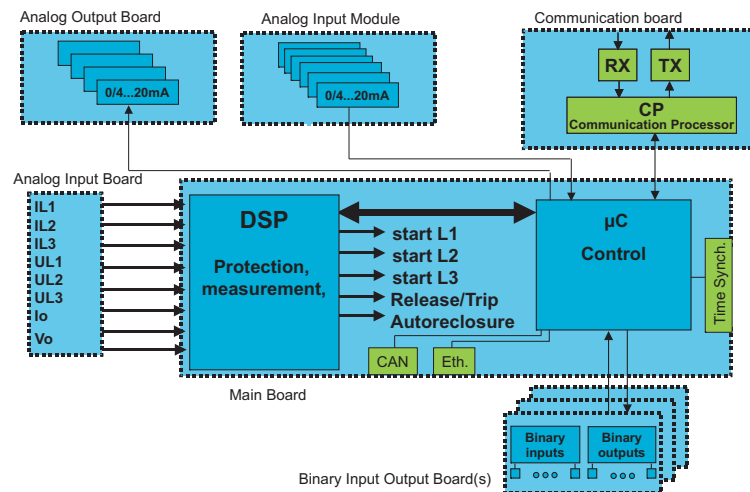

A050397

Fig. 3.-4 REF 542plus block diagram

The HMI control unit, as shown in Fig. 3.-5, features a back-illuminated liquid crystal display (LCD), eight push buttons, several LEDs and an electronic key interface. The language of the display can be selected by using the related configuration software tool, which is also used to define the protection and the control scheme.

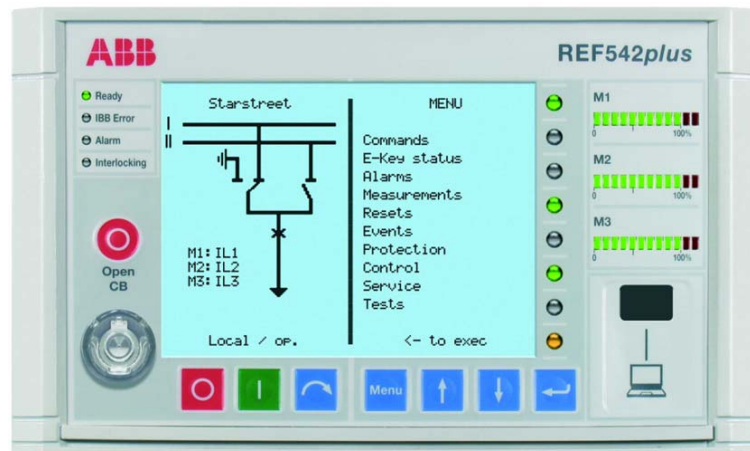

A050399

Fig. 3.-5 HMI control unit

The left side of the LCD display is reserved for the single line diagram. The right side is for plain text visualization such as measurement and protection events. The LCD backlight is switched off automatically after 20 minutes of inactivity.

The HMI is a complete system for the local management of the switchgear. The HMI allows the operator to set the protection functions, operate the primary objects, visualize measurements and events, reset alarms and change the unit working mode.

The HMI includes:

- Unit Ready LED
- Network Communication LED
- Alarm LED
- Interlocking Error LED
- Electronic Keys Sensor
- Object Control push buttons
- Menu Navigation push buttons
- Programmable LEDs
- PC interface
- Measurements Bars
- Text
- SLD view
- CB fast opening
- User defined command buttons

Unit Ready LED

This green LED is turned on when the unit is operational. This LED is switched off when there is no power supply or when the unit is not operational.

Network Communication LED

This LED is meaningful only when the REF 542plus is equipped with a communication module and configured to use it. When a communication module is detected inside the unit, the LED turns on to green. If a communication module is not detected or fails, the LED turns from green to red. When the unit is not configured for the communication, the LED is switched off.

Alarm LED

The alarm LED turns to red when user-defined alarms become true. Several arbitrary alarm conditions can be defined and configured with the operating tool. Alarm conditions can be a trip of a protection function, loss of SF6 in the circuit breaker and so on. When this LED is on, it is not possible to close the circuit breaker or to download a new configuration. The alarm condition has to be removed and the alarm must be acknowledged first.

Interlocking Error

The interlocking error LED is usually green. The LED turns temporarily to red when the user attempts an operation that would violate the programmed interlocking conditions, for example switching a disconnecter with the circuit breaker in closed position.

Electronic Keys Sensor

The Electronic Keys Sensor recognizes electronic keys. Two different electronic keys are provided. One key allows changing the parameters of the protection functions. The other one is used to change the control modes. The sensor automatically detects which key has been inserted. The two keys are labeled “Protect” and “Control” to distinguish them. When required, a general key to access both modes can be provided. It is also possible to program an 8-character custom code in the keys to increase the security levels or for any other specific reason. This can be done easily with a program available on request.

Object Control

Object Control push buttons allow operating the primary objects.

Menu Navigation

Menu Navigation push buttons allow navigating through the REF 542plus menu.

Programmable LEDs

8 freely programmable, three-color LEDs are available for indications. There are 4 pages of these LEDs. The assignment of the LED to a specific condition is done with the Operating Tool.

PC interface

The PC interface to be used to connect REF 542plus with the PC can be the infrared (IrDa) serial or TCP/IP port. By using an appropriate cable and Operating Tool, the following actions are possible:

With the IrDa connection:

- Downloading a configuration into the unit
- Uploading the current configuration from the unit
- Uploading the fault recorder
- Uploading other information (measurements, binary inputs status, binary output status).

With Ethernet TCP/IP connections:

- Downloading a configuration into the unit
- Uploading the current configuration from the unit
- Downloading a new firmware of the mainboard into the unit
- Downloading a new firmware of the communication board into the unit

Measurements Bars

3 freely programmable bars are provided for a quick inspection of the switchgear load situation. The three bars are marked M1, M2, and M3. Each bar is composed of twelve LEDs: ten green and two red. The ten green LEDs are normally dedicated to display between 0% and 100% of the nominal value of the configured measurement, each LED corresponding then to 10% of the nominal value. The two red LEDs indicate an overload condition of 20%. The measurement displayed by the bar is set with the Operating Tool. M1..M3 reference text can be configured and displayed on the display is display's graphical side.

Text

There is a textual part of the LCD, which shows the menu, the measurement values, the events and any information accessible through the menu structure.

SLD view

The SLD view is the graphical part of the LCD. This part shows the single line diagram of the switchgear. The status of the primary objects is dynamically updated after every operation: for example, if the circuit breaker has been opened, the SLD view will reflect it.

Open CB for Fast Opening

When pressed simultaneously with the normal open button, the **Open CB** button allows the fast opening of the circuit breaker independently from the selected control mode. This feature must be enabled in the unit with the Operating Tool.

Moreover, it is also possible to have several, completely user defined command buttons on the HMI. These virtual push buttons are available from the dedicated HMI menu. During REF 542plus configuration, the user defines what command buttons are required. Typical examples might be: start of a transfer switch or of any other automation sequence, fault recorder activation, start of a load shedding sequence and so on.

Due to the user defined command buttons, REF 542plus automation capabilities can cope with any requirements.

4. Functions

REF 542plus switchgear protection and control unit integrates all secondary functions in a single unit. This multifunctional unit features also a self-monitoring function. All functions are designed as freely configurable software modules. Therefore, a wide range of operation requirements in MV stations can be met without any problems. The versatility of the software makes it possible to use the REF 542plus on every switchgear irrespective of the specific application required.

4.1. Configuration

The REF 542plus unit is configured for the specific application using the Operating Tool running on a personal computer. With the graphical editor, the needed functions blocks are combined together. The available protection functions are represented with specific function blocks, which can be combined with logic function to define the required protection and automation scheme. The flexibility of REF 542plus is advantageous for defining control functions and automation sequences which can, for example, include the interlocking of the switching devices, blocking the release of specific protection functions, as well as starting switching sequences.

The REF 542plus unit provides a wide range of logical functions so that each specific requirement can be met. The functions include logical gates such as AND, OR, timers, counters, pulse generators, flip-flops and so on. All functions in the switchgear are specified in collaboration with ABB. The REF 542plus configuration is a file which is then downloaded into the unit via the optical serial port on the HMI or via Ethernet TCP/IP port. The Operating Tool allows also these additional functions once connected to the HMI via the serial cable:

- Protection functions setting
- Measurement values read-out
- Online binary inputs and outputs status read-out
- Fault recorder data acquisition

The Operating Tool allows an online, real-time monitoring of the internal control signals and logic states, a powerful tool for application debugging.



The specific software configuration of the required protection scheme can only be carried out in-house at ABB.

4.2. Measurement

REF 542plus can have a maximum of 8 analog input channels for measuring current and voltage signals. These channels are organized into three groups.

Group 1 and group 2 have to be homogeneous, which means they can measure 3 currents or 3 voltages. For example, measurement of 1 current and 2 voltages is not allowed. Group 3 can get any type of signals, for example, 2 currents, 2 voltages, or 1 current and 1 voltage. REF 542plus analog input is designed to be very flexible in order to support all the protection functions of the unit itself.

Group 1 and group 2 can be used for homogeneous current or voltage measurements both from instrument transformers and non-conventional sensors. Group 3 can be used in a heterogeneous way, but in most cases with instrument transformers only. For example channel 7 in group 3 can be used for earth-fault current with current transformer type input, or for the synchro-check function with voltage transformer type input.

The most common configuration uses three current and three voltage inputs and one earth fault current input. All values are shown on the display as primary values. The values registered over an extended time period, for example, energy, number of CB operations, and maximum and measurement values are permanently saved. Even after power interruptions this data is still available. Using this common configuration, the following measured values are displayed:

4.2.1.

Directly measured values

- Phase currents, three phases
- Phase line voltages, three phases
- Residual current (it can be calculated)
- Residual voltage (it can be calculated)
- Frequency

4.2.2.

Calculated values

The following values can be calculated from the measured quantities listed above:

- Phase or Line voltages, three phases
- Average value/maximum value current, three-phase (determined over several minutes)
- Apparent, active and reactive power
- Power factor
- Active and reactive energy
- THD (total harmonic distortion)
- Average value/maximum value for active and reactive power

4.2.3.

Other values

Moreover, the following quantities can be provided for monitoring purposes:

- Operating hours
- Switching cycles

- Total switched currents
- Metering pulses from an external metering device (up to 10)

4.2.4. **Monitoring and self-diagnosis**

The REF 542plus offers several features for monitoring the primary part as well for self-diagnosis. The following computed quantities are available for primary part monitoring:

- Maximum and mean currents in the observation period (0 ... 30 min)
- Sum of interrupted currents
- Working hours
- Number of switching cycles (open-close circuit breaker)
- Spring charging time supervision (when applicable)
- Opening coil supervision

The REF 542plus is equipped with self-diagnosis routines that constantly check the hardware and software modules status. Every REF 542plus binary input and output module is equipped with a watchdog contact that triggers in case of fault or power loss. This contact can be used to detect unit failure and to initiate the appropriate actions. Analog input channels can be optionally supervised. A broken wire in the connection with an instrument transformer or a sensor can be detected and an alarm can be activated.

4.3. **Protection**

REF 542plus offers a wide range of functions for protection. As previously mentioned, a wide range of protection schemes for the protection of several system components can be configured. The available protection functions can be combined to form the required protection scheme.

Current protection

- Inrush blocking (68)
- Overcurrent instantaneous (50)
- Overcurrent definite time, 2 thresholds (51)
- Overcurrent directional, 2 thresholds (67)
- Overcurrent IDMT (51 IDMT)
- Overcurrent with freely programmable trip characteristic 8 thresholds (51)
- Overcurrent directional with freely programmable trip characteristic 8 thresholds (67)
- Earth fault, 2 thresholds (51N)
- Earth fault IDMT (51 IDMT)
- Earth-fault directional, 2 thresholds (67N)

Voltage protection

- Overvoltage instantaneous (59)
- Overvoltage definite time, 2 thresholds (59)
- Undervoltage Instantaneous (27)
- Undervoltage definite time, 2 thresholds (27)
- Residual overvoltage, 2 thresholds (59N)

Line protection

- Distance protection V1 (21)
- Distance protection V2, 8 thresholds per net (21)
- Fault locator, 1 threshold per net

Differential protection

- Differential protection for motors and transformer (87)
- Restricted earth-fault for transformer (87N)

Thermal protection

- For cables, motors and transformers (49)

Motor-specific protection

- Number of starts counting (66)
- Locked rotor (51LR)
- Motor start (51MS)
- Low load (37)
- Unbalanced load (46)

Power quality mitigation

- Power factor controller (55)
- Switching resonance protection
- THD protection

Other protections and related functions

- Frequency protection (81), 6 thresholds per net
- Synchrocheck (25)
- Fault recorder
- Autoreclosure (79)
- Switch onto fault, 1 threshold per net
- Lock-out (86)
- Reverse power (32)



Up to 24 protection functions can be installed inside the REF 542plus unit. The maximum number is anyway dependent upon the available processing power.

4.4. Control

The control and automation capabilities inside the REF 542plus are extremely powerful. Simple interlocking against switching errors as well complex load-shedding schemes can be easily implemented with the control possibilities offered by the REF 542plus.

It is also possible to implement interlocking between the switchgear connected to the same busbar system. This requires the availability of status information of the switching devices to and from other switchgear. The status information must be provided by:

- Conventional, hard-wired ring bus system
- Using the ABB station automation system with ABB LON protocol per LAG 1.4, which allows horizontal communication among the REF 542plus units connected on the interbay bus
- Using the CAN Open digital fieldbus (only to be applied by the ABB switchgear companies)

The REF 542plus foresees different control modes, selectable with the control key. In local mode, the HMI control buttons are used to operate on the primary objects. Remote operations are inhibited. In remote control mode, only switching actions from a remote control device like a station automation system are permitted. Local control from the HMI is inhibited. All possibilities to operate on the primary objects can be inhibited by setting the unit to the no control mode.

4.5. Event recording

The last 30 recorded events can be shown locally on the HMI. Most of the events are related to protection activities. In addition to displaying the event name, additional information about the event, time, date and the RMS value of the short-circuit current switched off by the CB are provided. Each event is stamped with the time and the date. Events are stored in non-volatile memory, so they are maintained also in case of a power loss.



Fig. 4.5.-1 Event list on the LCD of the HMI

A050403

4.6. Fault recorder

The REF 542plus unit is equipped with a powerful and flexible fault recorder function. This function can be used to record at most eight analog input channels and thirty-two binary signals. The analog input signals are recorded with a sampling rate of 1.2 kHz for a time interval of at least 1 second and for a maximum of 5 seconds. The recording time is a combination of pre- and post-fault time. The total recording capability is 5 seconds. There can then be configured 5 records of 1 seconds or a single record of 5 seconds. The recording can be started by a protection event, by a binary signal change or by any user-defined condition.

Fault records can be transferred locally to a personal computer from the HMI optical port with the Operating Tool or from the communication interface. When extracted with the Operating Tool, the fault records are automatically converted into the standard COMTRADE format. When retrieved from the communication interface, they can be converted with a utility program. Fault records are stored in non-volatile memory, so they remain available also after a power failure.

Fault records can be exported and converted with the configuration software. The transfer of fault records can be done also via the interbay. Fig. 4.6.-1 shows a record of a cross-country fault in an earth-fault compensated MV system starting with the earth fault.

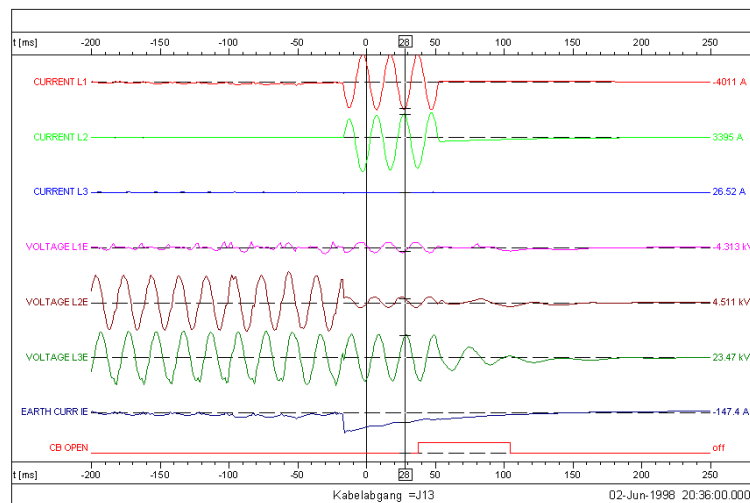

A050404

Fig. 4.6.-1 Record of a cross-country fault in MV system

4.7. Time synchronization

REF 542plus is equipped with an internal real-time clock, which is used to time stamp events. The internal clock is buffered by a special capacitor. In case of a DC power supply failure, the stored electrical energy in the capacitor ensures continued operation of the internal clock for at least another two hours. The date and time of the clock can be set via the HMI control unit.

REF 542plus internal clock can be kept in synchronization with an external clock in different ways.

When connected to an ABB station automation system, REF 542plus is synchronized via an interbay bus using the facilities of, for example, SPA protocol or ABB LON per LAG 1.4 protocol. For connection to third party system the standard protocol IEC 60870-5-103, IEC 61850 or modified Modbus RTU protocol are available. If better accuracy is required, REF 542plus can be synchronized using the dedicated IRIG-B optical input port and a GPS master clock. The accepted timeformats are IRIG format B 000, B002 and B003. The Fig. 4.7.-1 shows the time distribution architecture for the synchronization.

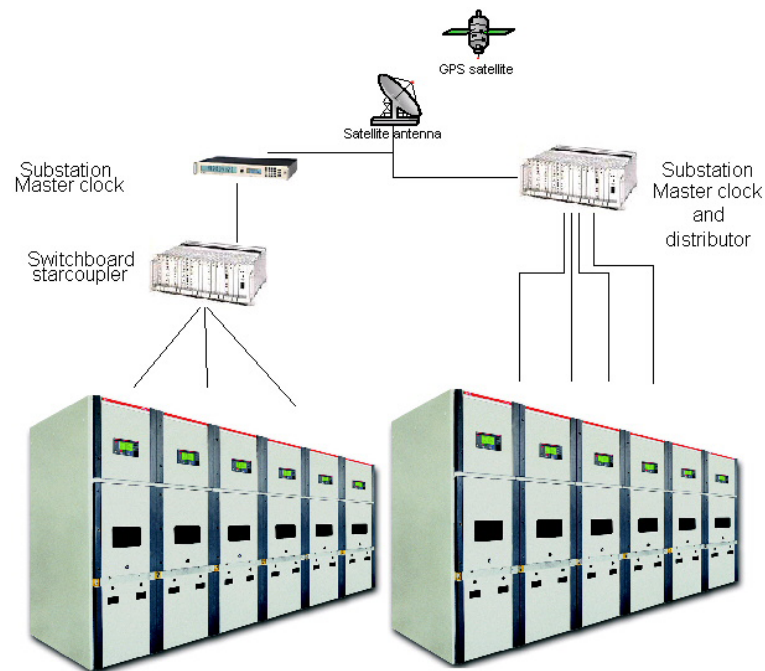

A050501

Fig. 4.7.-1 Synchronization of the internal clock by a GPS master clock

4.8. Interface to the primary process

The REF 542plus offers a flexible interface to the primary process which is described in the following sections.

4.8.1. Analog inputs

REF 542plus switchbay protection and control unit is designed for connecting to non-conventional current and voltage sensors as well as to instrument transformers.

At most 8 analog input channels are available. Due to their linear characteristic, modern current and voltage sensors provide greater accuracy and reliability in signal measurements. Compared to instrument transformers, the new sensors have the following advantages:

- Higher linearity
- High accuracy
- Compact dimensions
- Wide dynamic range
- Easy integration in the panels

The current sensor is based on the Rogowsky coil principle and consists of a single air-wound coil. Due to the lack of an iron core, the saturation effects of conventional current transformers do not exist anymore. Current sensors are thus well suited for the deployment of distance and differential protection functions.

The current sensor output is a voltage signal, proportional to the derivative of the primary current being measured. The numerical integration of the signal is performed by the DSP in the REF 542plus unit. The current sensors cover a range between 0.5 to 2.0 of the rated current. The 80 A current sensors, for example, are very suitable for applications between a current range of 40 A to 160 A. Other current sensors are defined for the range 120 A to 480 A, 320 A to 1280 A and 800 A to 3200 A.

The voltage sensor is based on the resistive divider principle. Therefore, the voltage sensor is linear throughout the whole measuring range. The output signal is a voltage, directly proportional to the primary voltage. The following Fig. 4.8.1.-1 and Fig. 4.8.2.-1 shows a combined sensor. The current and voltage sensors are encapsulated into a single resin unit. Therefore, they are referred to as "combined" or "combi sensors".



A050502

Fig. 4.8.1.-1 Combined sensor

Coupling electrode is incorporated in the sensors, for voltage detecting systems (VDS).

4.8.2. Binary inputs and outputs

The REF 542plus unit acquires the primary objects status with auxiliary contacts, which are read by binary inputs, and sends commands using binary outputs. Several signals coming from other components are also monitored. Among others, the following operations are implemented using binary inputs and outputs:

- Primary objects control and interlocking in the switchgear
- Primary objects status acquisition (for example circuit breaker in opened/closed position)
- Circuit breaker spring supervision (when applicable).

Binary inputs are isolated by opto-couplers. Binary outputs can be implemented either with mechanical relays or with static (semiconductor) devices. In a switchgear with directly driven motors, static power outputs are usually required



A051256

Fig. 4.8.2.-1 Combined sensor in block type (DIN) execution

4.9. Interfacing a station automation system

An optional communication module can be provided for interfacing a station automation system. The six different protocols available for the REF 542plus make possible to interface any kind of station automation system, both from ABB or from third parties.

The following typical functions are possible:

- Primary objects status monitoring
- Primary objects control
- Protections parameterization
- Measurements, alarms end events acquisition
- Fault recorder data acquisition

The available protocols are:

- SPA
- ABB LON according to LON Application Guide (LAG) 1.4 definitions
- MODBUS RTU
- MODBUS TCP
- IEC 60870-5-103 with the extensions for control functions according to VDEW (Vereinigung Deutscher Elektrizitätswerke = Association of German Utilities)
- IEC 61850 (only vertical communication, no GOOSE messages provided)

The first two protocols, SPA and LON according to LAG 1.4, are ABB specific. The LON LAG 1.4 protocol has specific features for high accuracy time synchronization. In this case, the REF 542plus units are synchronized from the interbay bus. The other protocols, MODBUS RTU, MODBUS TCP, IEC 60870-5-103 and IEC 61850 guarantee an open connectivity to any third party system. MODBUS RTU and SPA protocols can run on a module equipped with two serial channels. Simultaneous use of the two serial channels as physical redundancy is not possible. The connection to two different SCADA systems is possible (for the SPA protocol, provided that one of the two SCADA systems is for monitoring purposes only).

Moreover, the presence of the Ethernet port located on the mainboard of the REF 542plus extends the potential future connectivity of the REF 542plus unit. Multipoint communication can now be operated, for example, ABB LON protocol on the optional communication module and simultaneously MODBUS TCP and the embedded Web server.

4.10.

Embedded Web Server

REF 542plus can be equipped with an embedded Web server for monitoring purposes (WEB REF). The Ethernet port on the main module provides connectivity to the Web. By using a standard PC with a commercial Web browser, the user can gain access to the substation units using the Web facilities. Monitoring the substation units is then possible from everywhere; the implemented security mechanism prevents unwanted accesses and guarantees the required safety.

As soon as the browser is connected to the REF 542plus unit, the switchgear overview is displayed. From here, the user can scroll through the single line diagram. Clicking on the address button, the specific REF 542plus unit single line diagram is loaded, with also all the information that would be normally available standing in front of the HMI. REF 542plus data are available in read mode only (monitoring access).

WEB REF makes also available the possibility to send SMS messages or e-mail via the GSM network upon specific, user-defined condition (trips, alarms, etc.). A suitable GSM modem must be connected to the mainboard module.

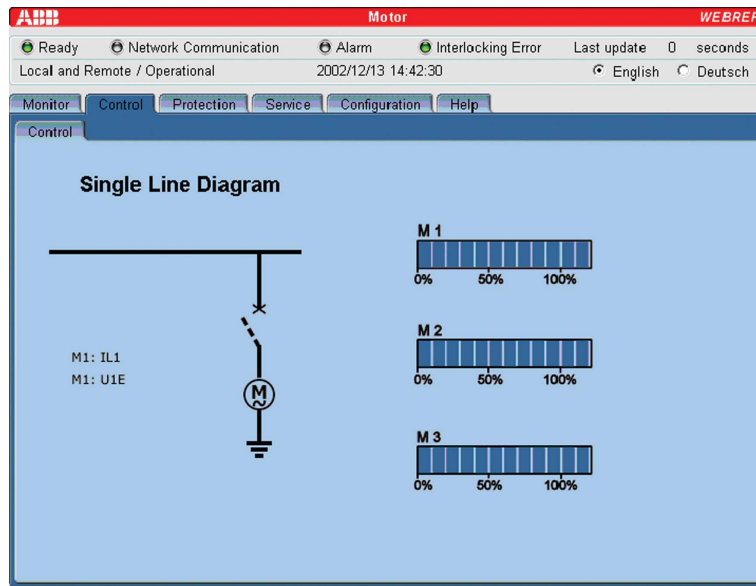

A051259

Fig. 4.10.-1 REF 542plus main page as seen from the Internet browser

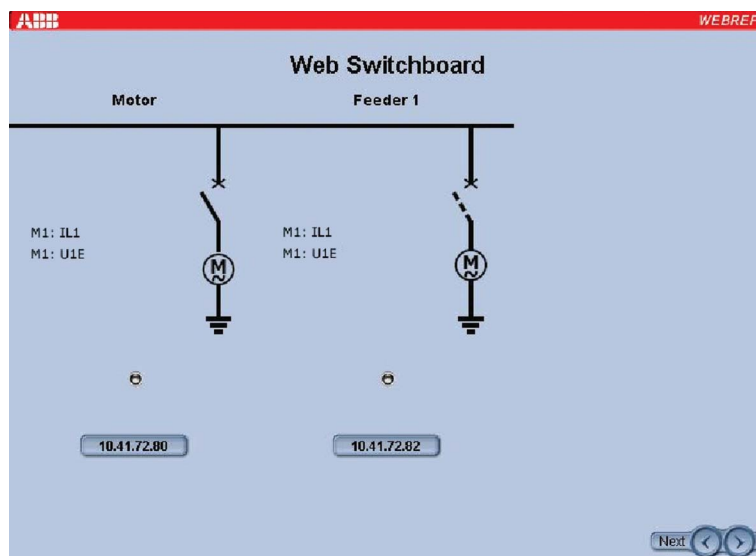

A051260

Fig. 4.10.-2 Switchgear equipped with REF 542plus: single line diagram as seen from the Internet browser

4.11.

CAN Open (only for ABB switchgear companies)

The REF 542plus is equipped on the main module with a CAN Open standard interface. The CAN Open interface has two main purposes:

- Replacing the switchgear internal hard-wired connections by means of a high-speed digital bus;
- CAN Open standard devices connectivity (intelligent IO modules, sensors, and so on)

Replacing the switchgear internal hard-wired connections by means of a high-speed digital bus allows building new highly standardized switchgear with a more efficient life cycle. Fast interlocking data among several REF 542plus units can be exchanged on the CAN Open bus.



The utilization of the CAN Open bus is limited to the ABB switchgear company. Stand alone devices may not be operated with the CAN Open system.

In addition, the digital bus moves “the intelligence” closer to the process, allowing the construction of switchgear systems with increased configuration and maintenance flexibility. The CAN Open interface allows connecting any off-the-shelf product compliant with the CAN Open standard, thus making the automation capabilities of the REF 542plus almost unlimited.

The Fig. 4.11.-1 describes an architecture where two REF 542plus units and some IO modules are connected with the CAN Open.

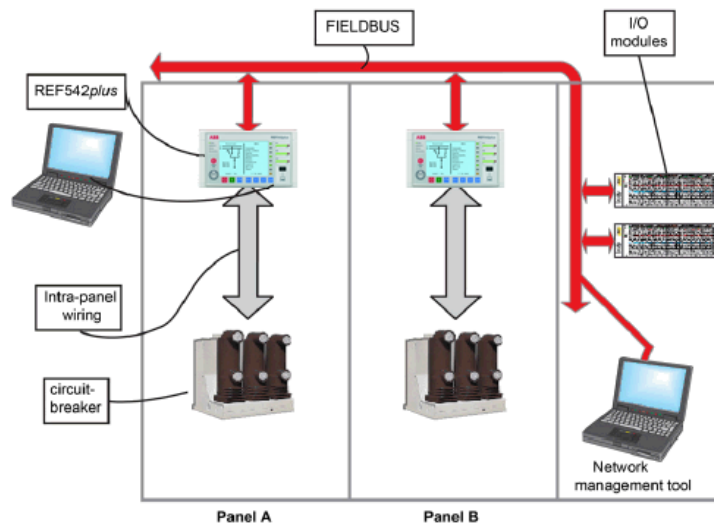

A051257

Fig. 4.11.-1 REF 542plus CAN Open connectivity

4.12. ABB Product Data Registration

The ABB Product Data Registration system is used to collect all the composition information throughout the IED's life cycle and add them in ABB's data server. ABB lifecycle services collects product data like product hardware, product software, site information related to an IED. The firmware of each REF 542plus terminal detects changes in the hardware composition or in the firmware. Thanks to the existing history record technical support as well as services and repairs can be provided by ABB as soon as possible.

5. Construction

5.1. Base unit versions

The REF 542plus base unit housing is made from aluminum sheets. Its exterior is chromatinized both to protect the housing against corrosion and to improve immunity against EMC disturbances. Two different housings are available:

- Standard
- Wide

In both versions, at least the following modules have to be present:

- The power supply, the mainboard.
- The analog input module
- One binary input and output module

The standard housing can additionally house:

- Another binary input and output module
- Alternatively the communication module or the 4/0 ... 20 mA analog output module

Backplane differs from 4/0 ... 20 mA analog output module and communication module. The backplane type has to be specified.

The wide housing can additionally house:

- Other 2 binary input and output modules
- The communication module
- Alternatively the 4/0 ... 20 mA analog output module or the 4 ... 20 mA analog input module



The 4 ... 20 mA analog input module can be used with the wide housing only.

Standard housing summary

- One power supply
- One mainboard module
- One analog input module
- At most two binary input and output modules
- Optionally the communication module or the 4/0 ... 20 mA analog output one

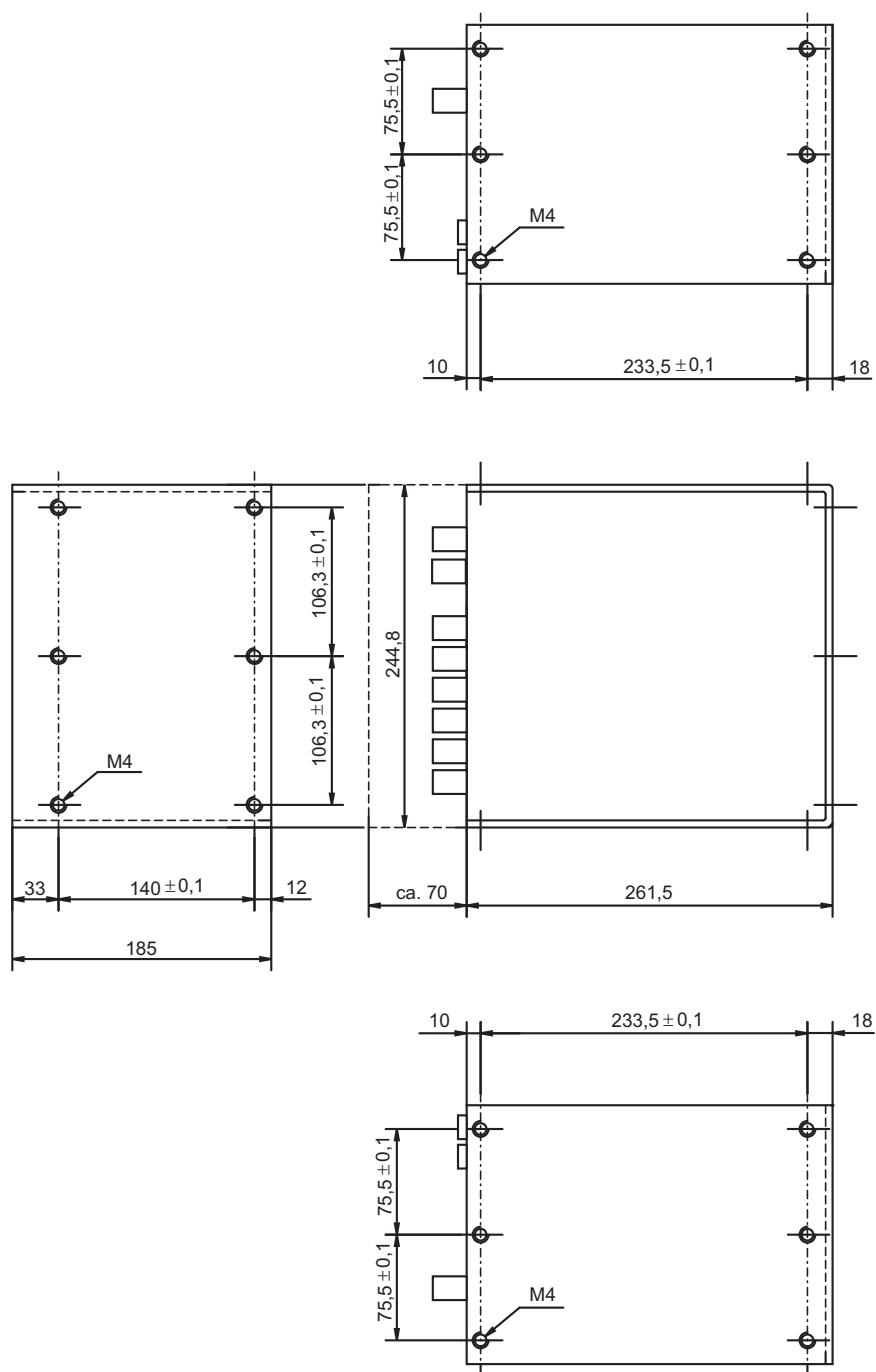

A051268

Fig. 5.1.-1 Standard housing version dimensions.

Wide housing summary

- One power supply
- One mainboard module
- One analog input module
- At most three binary input and output modules

- Optionally the communication module
- Optionally the 4 ... 20 mA analog input module or the 4/0 ... 20 mA analog output module

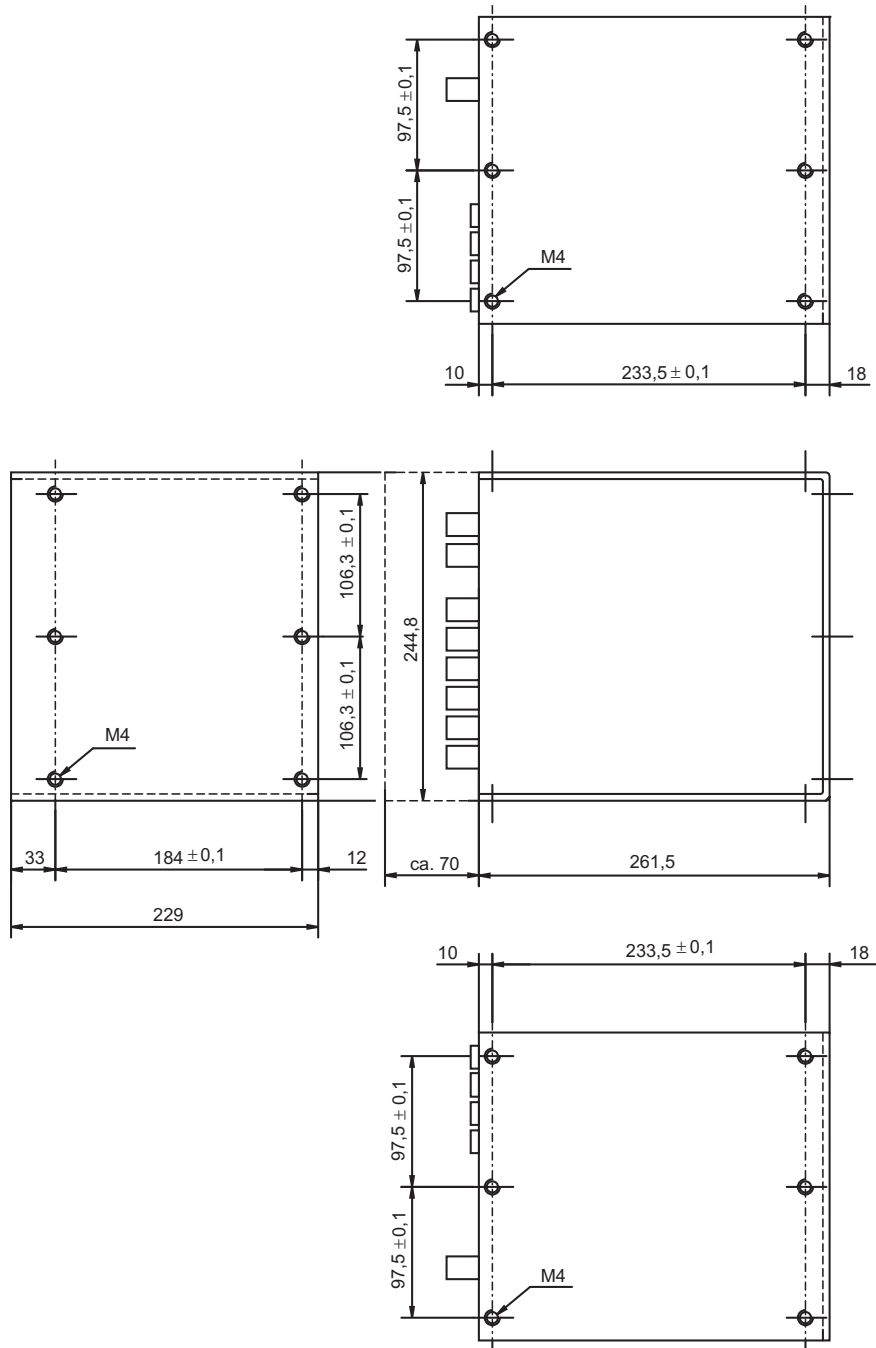

A051269

Fig. 5.1.-2 Wide housing version dimensions.

5.2. Mounting and installation

The Fig. 5.2.-1 shows an example of wide housing base unit installation inside a low voltage compartment.

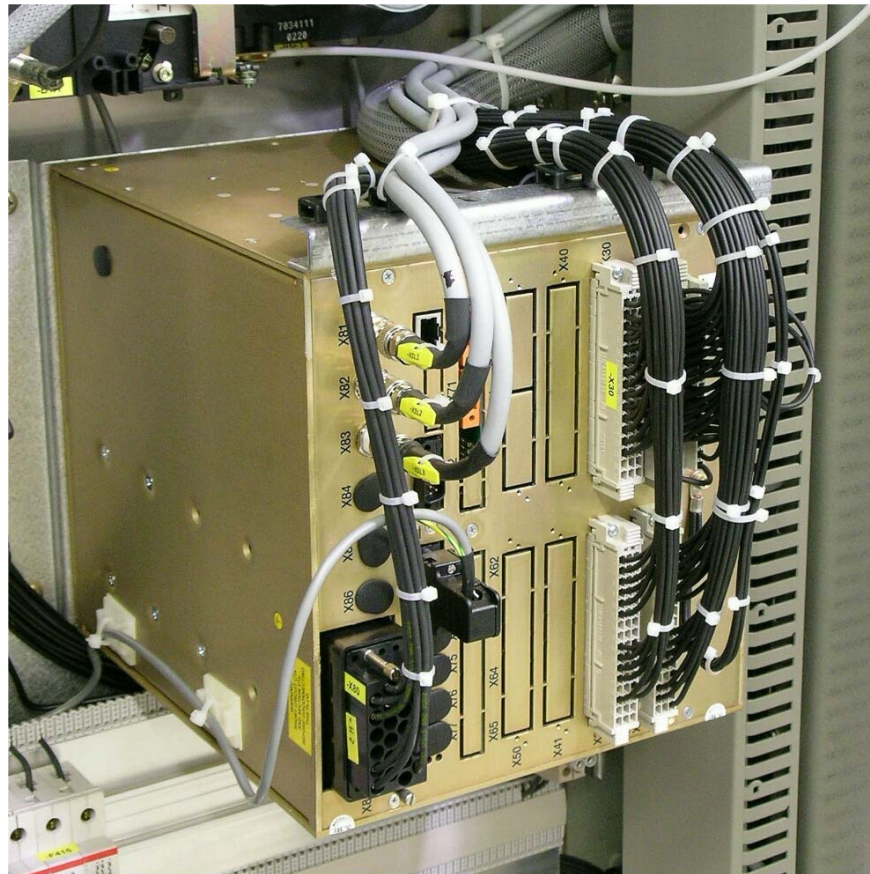

A051270

Fig. 5.2.-1 Base unit installation in the low voltage compartment of GIS switchgear



Use always the broad flexible cables for grounding of the housing. Also, use the whole low voltage compartment including the door to reduce the impact of the high frequency electromagnetic disturbances into the electronic circuit.

5.3. HMI

The HMI dimensions are shown in Fig. 5.3.-1 and Fig. 5.3.-2.

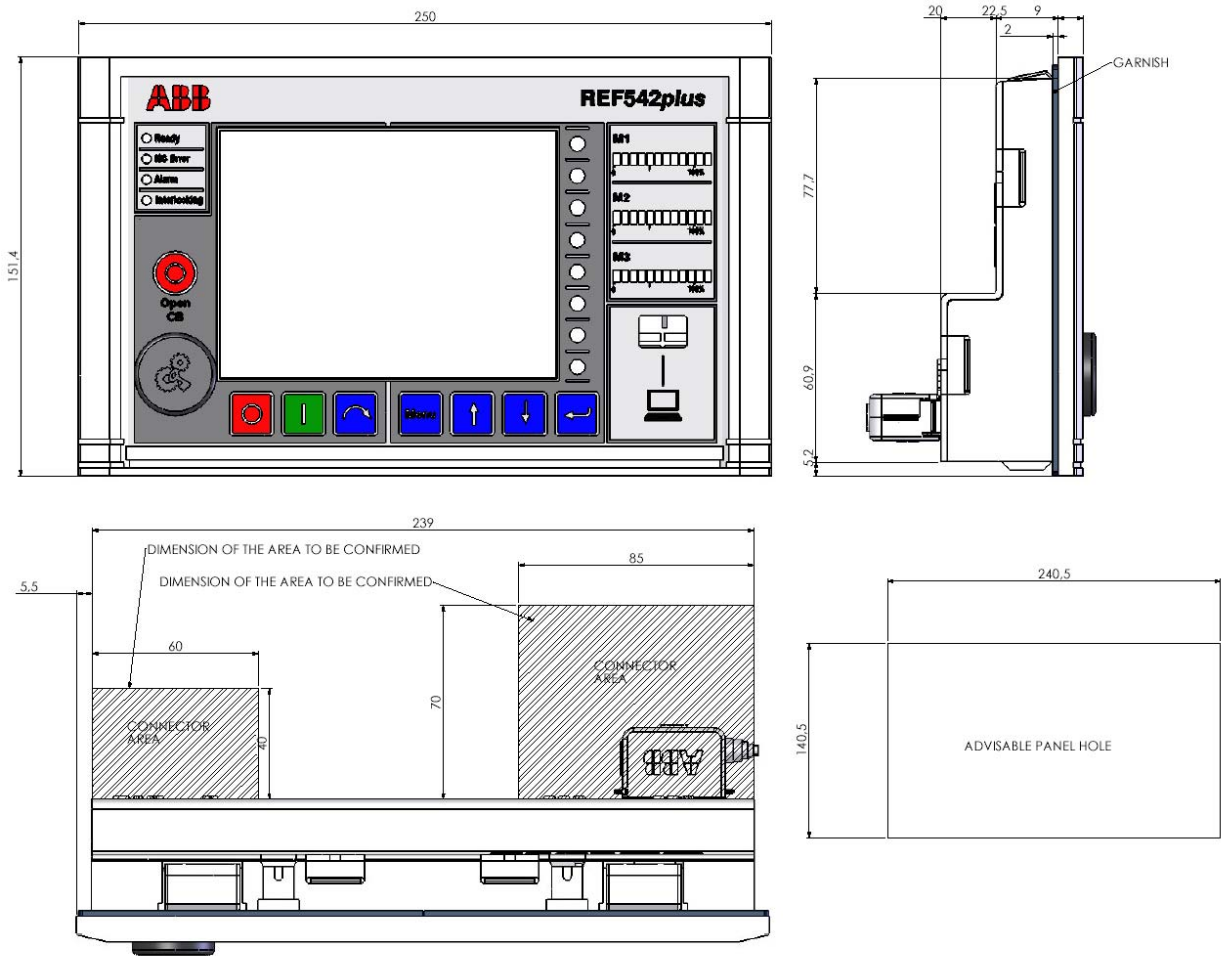

A051271

Fig. 5.3.-1 Dimensions of the HMI version without cover

The advisable panel hole is 240,5 mm x 140,5 mm. The existing connectors for the former version of the HMI can be used.

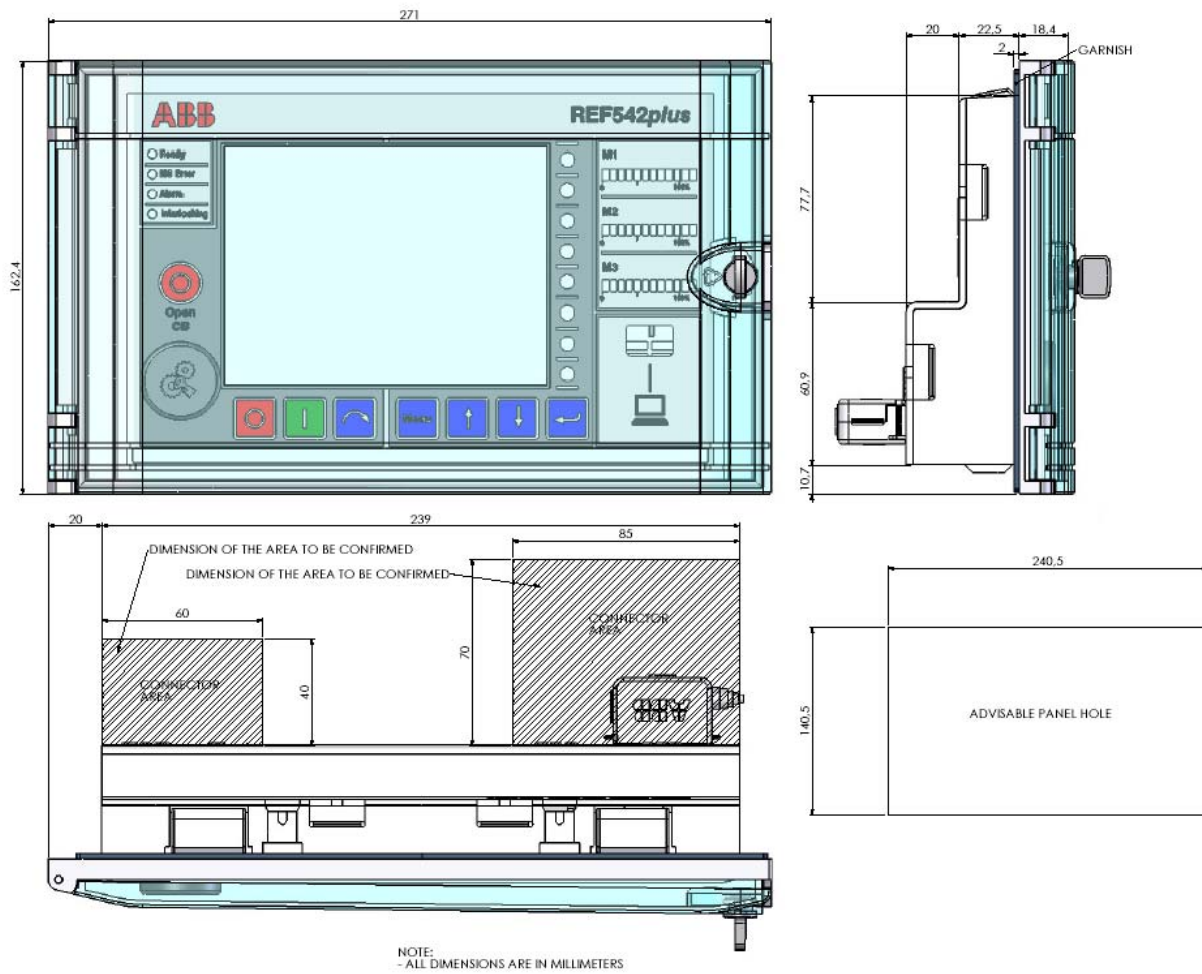

Fig. 5.3.-2 Dimensions of the HMI version with cover

A070119

The advisable panel hole is the same as before.

6. Technical data

6.1. Analog inputs

6.1.1. Measurements

The REF 542plus unit uses the same analog inputs both for measurements and protections.

Table 6.1.1.-1 Measurements

Quantity	Class	Range
Phase current, earth current	0.5	0.1-4I _n
Line voltage, phase voltage	0.5	0.2-1.5V _n
Active, reactive energy	2	-
Active, reactive, apparent power	1	-
Cosφ	1	-1 - +1
Frequency	0.02	40-75 Hz

To achieve highest accuracy the instrument transformers or the sensors must have 0.5 percent accuracy or better in the same range.

6.1.2. Protection

Table 6.1.2.-1 Protection functions and operation time

Protection functions	Class 3
Operation time	Class 3 or minimum ±15 ms

Table 6.1.2.-2 Current and voltage transformer input values

Rated current I _n	0.2 A or 1A or 5 A
Rated voltage U _n	100 V - 125 V
Rated frequency f _n	50 Hz or 60 Hz

Table 6.1.2.-3 Thermal load capacity

Current path	250 I _n (peak value), dynamic 100 I _n for 1s, 4 I _n continuous
Voltage path	2 U _n /√3 continuous

Table 6.1.2.-4 Consumption

Current path	≤ 0.1 VA at I _n
Voltage path	≤ 0.25 VA at U _n

Table 6.1.2.-5 Current and voltage sensor input values

Voltage at rated current I_n	150 mV (rms)
Voltage at rated voltage U_n	2 V (rms)
Rated frequency f_n	50 Hz or 60 Hz

6.1.3.**Analog input modules**

Several different types of analog input modules are available to manage the different protection functions.

The modules are equipped with the following combinations of input current and/or voltage transformers:

- 3 or 6 current transformers for phase currents
- 3 or 6 voltage transformers for phase-to-ground or phase-to-phase voltages
- 1 or 2 current transformers for residual currents
- 1 or 2 voltage transformers for residual voltages

There are also versions for sensor inputs and mixed ones, to connect both conventional instrument transformers and sensors. At most, eight input channels are available. If programmed, input channels can be supervised.

The first three analog input channels (1-3) are designed for connecting current transformers and the next three channels (4-6) for connecting voltage transformers. The last two channels (7 and 8) are designed for measuring the residual current and residual voltage.

The power flows can still be calculated, if six current transformers, for example in case of transformer differential protection, are connected and the related line voltages of the network are connected to the last two analog input channels. The analog input channels 1 and 3 must be connected to the current transformers of NET1. The last two input channels 7 and 8 must be connected to the line voltages of NET1. If required, the power flow calculation can be done in the bus tie part of the switchgear, where six voltage transformers are connected to the analog input channels 1-6. The analog input channels 4 and 6 must be connected to the phase voltage of NET1. The last two input channels 7 and 8 must be connected to the current transformer of NET1.

6.1.4.**Reaction time**

In this context the protection reaction time is defined as the time elapsed between the fault detection and the closing of the contact that gives supply to the circuit-breaker tripping coil (or the equivalent tripping mechanism for magnetic drive or contactors). This time is the sum of different intervals:

1. Fault detection time
2. User defined pre set delay (for definite time protection functions)
3. Trip information processing
4. Relay output contact actuation

The REF 542plus is a protection and control unit and the programmed automation logic is executed cyclically in a PLC-style mode. The cycle time, in the range of ten millisecond, is depending upon the logic complexity.

The REF 542plus has an internal fixed compensation both for the relay output contact actuation time and for the logic execution time. Nevertheless, the actual trip information processing time depends upon the complexity of the actual logic programmed inside the unit.

As a result, the protection reaction time, in the worst case, can be the user-defined preset delay plus twice the cycle time.

Direct channel

In extremely demanding applications, the protection has to react as fast as possible and the system behavior has to be absolutely deterministic. The REF 542plus offers then to the protection system designer the direct channel option.

Using this option, the programmed logic execution flow inside the unit is skipped and the trip command is instantly delivered to the switching object representing the circuit breaker. All the interlocking conditions are nevertheless respected and assured. Should the circuit breaker be blocked for any reason, for example, insufficient SF6 pressure, the trip command is not actuated. The direct channel option grants then an absolutely deterministic behavior to the REF 542plus protection functions.

6.2.

Protection functions' technical data

The following Table 6.2.-1 illustrates the protection functions' technical data.

Table 6.2.-1 ANSI code Protection function and parameters

Current protection functions		
68	Inrush stabilization (only in connection with 50 and 51)	N = 2.0 ... 8.0 M = 3.0 ... 4.0 Time = 200 ... 100 000 ms
68	Inrush harmonic	Min current threshold = 0.05 ... 40.00 x I _n Fault current threshold = 0.05 ... 40.00 x I _n Harmonic ratio threshold = 5 ... 50 %
50	Overcurrent instantaneous	I _{>>>} = 0.100 ... 40.000 x I _n t = 15 ... 30 000 ms
51	Overcurrent high	I _{>} = 0.05 ... 40.00 x I _n t = 20 ... 300 000 ms
51	Overcurrent low	I _{>} = 0.05 ... 40.00 x I _n t = 20 ... 300 000 ms
51 IDMT	Overcurrent IDMT (inverse definite minimum time)	Inverse time characteristics: Normal, Very, Extremely and Long-time inverse I _e = 0.050 ... 40.000 I _n K = 0.050 ... 1.500

Technical Reference Manual

50/51	Overcurrent with free programmable characteristic (8 thresholds available)	$I_s = 0.050 \dots 40.000 \times I_n$ $t \text{ (def)} = 0.015 \dots 300.000 \text{ s}$ $A = 0.005 \dots 200.000$ $P = 0.005 \dots 3.000$ $B = 0.000 \dots 50.000 \text{ s}$ $T_d = 0.050 \dots 5.000$ $T_r = 0.020 \dots 100.000 \text{ s}$
67	Overcurrent directional high	$I_{>>} = 0.050 \dots 40.000 \times I_n$ $t = 40 \dots 30\,000 \text{ ms}$ Direction = backward, forward
67	Overcurrent directional low	$I_{>} = 0.050 \dots 40.000 \times I_n$ $t = 40 \dots 30\,000 \text{ ms}$ Direction = backward, forward
67	Overcurrent directional with free programmable characteristic (8 thresholds available)	$I_s = 0.05 \dots 40.000 \times I_n$ $t \text{ (def)} = 0.040 \dots 300.000 \text{ s}$ $A = 0.005 \dots 200.000$ $P = 0.005 \dots 3.000$ $B = 0.000 \dots 50.000 \text{ s}$ $T_d = 0.050 \dots 5.000$ $T_r = 0.020 \dots 100.000 \text{ s}$ Direction = backward, forward
Earth Fault		
51N	Earth fault high	$I_{0>>} = 0.050 \dots 40.000 \times I_n$ $t = 40 \dots 30\,000 \text{ ms}$
51N	Earth fault low	$I_{0>} = 0.050 \dots 40.000 \times I_n$ $t = 40 \dots 30\,000 \text{ ms}$
51N IDMT	Earth fault IDMT (inverse definite minimum time)	Inverse time characteristics: Normal, Very, Extremely or Long-time inverse $I_e = 0.05 \dots 40.00 I_n$ $K = 0.05 \dots 1.5$
50N/51N	Earth-fault with free programmable characteristic (8 thresholds available)	$I_s = 0.05 \dots 40.000 \times I_n$ $t \text{ (def)} = 0.015 \dots 300.000 \text{ s}$ $A = 0.005 \dots 200.000$ $P = 0.005 \dots 3.000$ $B = 0.000 \dots 50.000 \text{ s}$ $T_d = 0.050 \dots 5.000$ $T_r = 0.020 \dots 100.000 \text{ s}$ Direction = forward, backward Net type = isolated (sin φ), earthed (cos φ)
67N	Earth fault directional, high	$I_{0>>} = 0.050 \dots 40.000 \times I_n$ $t = 40 \dots 30\,000 \text{ ms}$ $U_{0>>} = 0.02 \dots 0.70 U_n$ direction = forward, backward net type = isolated (sin φ), earthed (cos φ)
67N	Earth fault directional, low	$I_{0>} = 0.050 \dots 40.000 \times I_n$ $t = 40 \dots 30\,000 \text{ ms}$ $U_{0>} = 0.02 \dots 0.70 U_n$ Direction = forward, backward Net type = isolated (sin φ), earthed (cos φ)
67S	Earth fault directional, sensitive	$I_{0>} = 0.050 \dots 2.000 \times I_n$ $t = 100 \dots 10\,000 \text{ ms}$ Angle alpha = 0.0 ... 20.0° Angle delta = -180.0° ... +180.0° $U_{0>} = 0.05 \dots 0.70 U_n$

67N Sector	Earth fault directional, Sector (10 thresholds available)	Direction = Enable/disable (directional behavior) Start Criteria = neutral current magnitude/ neutral current basic angle $I_0 > = 0.002 \dots 8.000 \times I_n$ $U_0 > = 0.004 \dots 0.700 \times U_n$ $t = 30 \dots 60\,000 \text{ ms}$ Sector basic angle = $-180.0^\circ \dots +180.0^\circ$ Sector width = $0.0 \dots 360.0^\circ$ $I_0 >$ drop-off delay = $0 \dots 1000 \text{ ms}$ $U_0 >$ drop-off delay = $0 \dots 1000 \text{ ms}$
67N	Earth Fault directional with free programmable characteristic (8 thresholds available)	$I_s = 0.05 \dots 40.000 \times I_n$ $t \text{ (def)} = 0.040 \dots 300.000 \text{ s}$ $A = 0.005 \dots 200.000$ $P = 0.005 \dots 3.000$ $B = 0.000 \dots 50.000 \text{ s}$ $T_d = 0.050 \dots 5.000$ $T_r = 0.020 \dots 100.000 \text{ s}$
Voltage protection functions		
59	Overvoltage, instantaneous	$U_{>>>} = 0.100 \dots 3.000 U_n$ $t = 15 \dots 300\,000 \text{ ms}$
59	Overvoltage, high	$U_{>>} = 0.100 \dots 3.000 U_n$ $t = 40 \dots 30\,000 \text{ ms}$
59	Overvoltage, low	$U_{>} = 0.100 \dots 3.000 U_n$ $t = 40 \dots 30\,000 \text{ ms}$
27	Undervoltage, instantaneous	$U_{<<<} = 0.10 \dots 1.20 U_n$ $t = 15 \dots 30\,000 \text{ ms}$
27	Undervoltage, high	$U_{<<} = 0.10 \dots 1.20 U_n$ $t = 40 \dots 30\,000 \text{ ms}$
27	Undervoltage, low	$U_{<} = 0.10 \dots 1.20 U_n$ $t = 40 \dots 30\,000 \text{ ms}$
25	Synchronism check	Delta Voltage = $0.02 \dots 0.40 U_n$ Delta Phase = $5 \dots 50^\circ$ $t = 0.20 \dots 1000.00 \text{ s}$
59N	Residual overvoltage, high	$U_{NE>>} = 0.05 \dots 3.00 U_n$ $t = 20 \dots 300\,000 \text{ ms}$
59N	Residual overvoltage, low	$U_{NE>} = 0.05 \dots 3.00 U_n$ $t = 20 \dots 300\,000 \text{ ms}$
Motor protection functions		
49	Thermal overload protection with total memory	Nominal Temperature = $50 \dots 400 \text{ }^\circ\text{C}$ (nominal temperature at I_n) Nominal current (I_{Mn}) = $0.100 \dots 5.000 \times I_n$ (primary value of the nominal motor current) Initial temperature = $10 \dots 400 \text{ }^\circ\text{C}$ Time constant at $I < 0.1 \times I_{Mn} = 10 \dots 100\,000 \text{ s}$ Time constant at $0.1 \times I_{Mn} < I < 2 \times I_{Mn} = 10 \dots 20\,000 \text{ s}$ Time constant at $I > 2 \times I_{Mn} = 10 \dots 20\,000 \text{ s}$ Trip temperature = $50 \dots 400 \text{ }^\circ\text{C}$ Warning temperature = $50 \dots 400 \text{ }^\circ\text{C}$ Environmental temperature = $10 \dots 50 \text{ }^\circ\text{C}$ Reset Temperature = $10 \dots 400 \text{ }^\circ\text{C}$
51	MS Motor start	$I_{Mn} = 0.200 \dots 2.000 \times I_{Mn}$ (motor current) $I_s = 1.000 \dots 20.000 \times I_{Mn}$ (start value) $t = 40 \dots 30\,000 \text{ ms}$ $I > = 0.200 \dots 0.800 \times I_s$ (motor start)

Technical Reference Manual

51	LR Locked rotor (definite time characteristic)	$I_{Mn} = 0.200 \dots 2.000 \times I_n$ (motor current) $I_s = 1.000 \dots 20.000 \times I_{Mn}$ (start value) $t = 40 \dots 30\,000$ ms
66	Number of starts	n (warm) = 1 ...10 (number of warm starts) n (cold) = 1 ...10 (number of cold starts) $t = 1.00 \dots 7200.00$ s T (warm) = 20 ... 200 °C (warm start temp. threshold)
46	Unbalance load	$I_s = 0.05 \dots 0.30 \times I_n$ (start value of the negative phase sequence) $K = 0.5 \dots 30.0$ $t_{Reset} = 0 \dots 2000$ s Timer decreasing rate = 0 ... 100%
37	Low load	$P_n = 50 \dots 100\,000$ kW (primary values) Minimal load $P = 5 \dots 100\%$ x P_n Minimal current $I = 2 \dots 20 \%$ x I_n Operation time = 1.0 ... 1000.0 s
Distance protection		
21	Distance protection V1	Net type = high/low ohmic Earth start IE> = used, unused Switching onto faults = normal, overreach zone, trip after start Signal comparison overreach scheme time set = 30 ... 300 000 ms U/I start characteristic $I>$, $IE>$ and $IF>$ = 0.05 ... 4.00 x I_n $UF<$ = 0.05 ... 0.90 x U_n Phase selection = cyclic or acyclic Earth factor Factor $k = 0.00 \dots 10.00$, Angle (k) = -60° ... 60° 3 impedance stages, 1 overreach stage and 1 autoreclose control stage: $R = 0.05 \dots 120.00$ Ohm (secondary values) $X = 0.05 \dots 120.00$ Ohm (secondary values) $t = 20 \dots 10\,000$ ms Angle delta 1 = -45.00 ... 0.00° Angle delta 2 = 90.00 ... 135.00° $t = 20 \dots 10\,000$ ms 1 non-directional stage $t = 20 \dots 10\,000$ ms

<p>21</p>	<p>Distance protection V2, 8 thresholds per net available</p>	<p>Common settings: Operating status = On/Off Common operation counter = Used/Not used Network type = High/Low ohmic Impedance calculation: Minimum current and earth fault supervision $I_{min>} = 0.05 \dots 40.00 I_n$ $I_{o>} = 0.05 \dots 40.00 I_n$ $U_{o>} = 0.10 \dots 1.20 U_n$ Double earth fault: $U_{<} = 0.10 \dots 1.20 U_n$ Phase selection = cyclic or acyclic Load encroachment: $U_{load>} = 0.10 \dots 1.20 U_n$ $R_{forward} = 0.000 \dots 3.000 Z_n$ $R_{backward} = 0.000 \dots 3.000 Z_n$ Angle = 1 ... 60° Zones setting: Status = On/Off Function in use = Tripping/Signaling/Overreach Zone Works on = Phase/Earth/Phase and Earth PTT logic = OR/AND Trip logic (for transfer tripping) = Op. Time/Op. Time AND PTT/Op. Time OR PTT/PTT Load encroachment = Used/Not used Reaches = Used/Not used Angles (directional limitation) = Used/Not Used Direction = Forward/Backward/Not Used $R_{forward} = 0.000 \dots 3.00 Z_n$ $X_{forward} = 0.000 \dots 3.00 Z_n$ $R_{backward} = 0.000 \dots 3.000 Z_n$ $X_{backward} = 0.000 \dots 3.000 Z_n$ Angle delta1 = -45 ... 0° Angle delta2 = 90 ... 135° Time = 0.020 ... 300.000 s Earth factor (for maximum 4 line sections) Group 1 ... 4 Modulus = 0.00 ... 10.00 Angle = -60° ... 60°</p>
	<p>Fault locator, 1 threshold per net</p>	<p>Operating status = On/Off PTRC trigger mode = Not Used/Start/Trip Impedance calculation: Minimum current and earth fault supervision $I_{min>} = 0.05 \dots 40.00 \times I_n$ $I_{o>} = 0.05 \dots 40.00 \times I_n$ $U_{o>} = 0.10 \dots 1.20 \times U_n$ Up to 4 line sections (primary values) $R_1 = 0.001 \dots 50.000 \text{ Ohm/km}$ $X_1 = 0.001 \dots 50.000 \text{ Ohm/km}$ $R_o = 0.001 \dots 50.000 \text{ Ohm/km}$ $X_o = 0.001 \dots 50.000 \text{ Ohm/km}$ Length = 0.01 ... 100.00 km</p>
<p>Differential protection functions</p>		

87	Differential	Differential Transformer group = 0 ... 11 Transformer earthing = primary and/or secondary side Primary nominal current = 10.00 ... 100 000.00 A (prim value) Secondary nominal current = 10.00 ... 100 000.00 A (prim value) Threshold current = 0.10 ... 0.50 x I _r (p.u.) Unbiased region limit = 0.50 ... 5.00 x I _r (p.u.) Slightly biased region threshold = 0.20 ... 2.00 x I _r (p.u.) Slightly biased region limit = 1.00 ... 10.0 x I _r (p.u.) Slope = 0.40 ... 1.00 Trip by I _d > = 5.00 ... 40.00 x I _n Blocking by 2nd harmonic = 0.10 ... 0.30 x I _n Blocking by 5th harmonic = 0.10 ... 0.30 x I _n
87N	Restricted earth fault protection (restricted differential)	Reference nominal current = 1.00 ... 100 000.00 A Unbiased region threshold = 0.05 ... 0.50 x I _r Unbiased region limit = 0.01 ... 1.00 x I _r Slightly biased region slope = 0.01 ... 2.00 Slightly biased region limit = 0.01 ... 2.00 x I _r Heavily biased region slope = 0.10 ... 1.00 Relay operate angle = 60° ... 180° t = 0.04 ... 100.00 s
Frequency protection function		
81	Frequency protection	Start value = 40.00 ... 75.00 Hz, step 0.01 Hz Frequency gradient = 0.01 ... 1.00 Hz/s t = 0.10 ... 30.00 s U< = 0.10 ... 1.00 U _n Trip logic = frequency only / frequency AND frequency gradient / frequency OR frequency gradient
Frequency supervision		
	Frequency supervision	Start value = 0.04 ... 5.00 Hz Time = 1.00 ... 300.00 s
Power quality functions		
	Power factor controller	Switching sequence: linear or circular Switching hysteresis, neutral zone = 105 ... 200% x Q _{co} Pickup value = 0 ... 100% x Q _{co} Reactive power of smallest bank Q _{co} : 1.000 ... 20 000.000 kVar Configuration banks: 1:1:1:1, 1:1:2:2, 1:2:2:2, 1:2:4:4, 1:2:4:8 Number of banks = 1 ... 4 Max switching cycles = 1 ... 10 000 Set point cos φ = 0.7 ... 1.00 ind. or cap. Limiting value cos φ = 0.00 ... 1.00 ind. or cap. Method of operation: direct, integrating discharge blocking time: 1 ... 7200 s dead time: 1 ... 120 s power-on delay: 1 ... 7200 s duration of integration: 1 ... 7200 s
	High harmonic protection	Voltage THD start value = 5 ... 50% Voltage THD time delay = 0.01 ... 360.00 s Time = 0.05 ... 360.00 s RMS voltage start value = 0.10 ... 1.00 U _n

	Switching resonance protection	Voltage THD Start value = 5 ... 50% Delta Voltage THD Start Value = 1 ... 50 % Voltage THD Time Delay = 0.01 ... 60.00 s t = 0.05 ... 60.00 s PFC OP Time = 0.01 ... 120.00 s RMS Voltage start value = 0.10 ... 1.00 U _n
Other functions		
	Fault recorder	Time before fault = 100 ... 2000 ms Recording time = 1000 ... 5000 ms Time after fault = 100 ... 4900 ms Max. 5 records
79	Autorecloser	Operation mode = Start and Trip controlled, Start Controlled Number of reclosing cycle = 0 ... 5 Reclaim time = 10.00 ... 1000.00 s Specific/operation time, 1st shot = 0.04 ... 1000.00 s Dead time, 1st shot = 0.10 ... 1000.00 s Specific/operation time, 2nd shot = 0.04 ... 1000.00 s Dead time, 2nd shot = 0.10 ... 1000.00 s Specific/operation time, 3rd shot = 0.04 ... 1000.00 s Dead time, 3rd shot = 0.10 ... 1000.00 s Specific/operation time, 4th shot = 0.04 ... 1000.00 s Dead time, 4th shot = 0.10 ... 1000.00 s Specific/operation time, 5th shot = 0.04 ... 1000.00 s Dead time, 5th shot = 0.10 ... 1000.00 s
	Switch onto fault, 1 threshold per net	Operating status = On/Off Fault criteria: I>/I< OR (IF> AND UF<)/Overreach Zone I> = 0.050 ... 40.000 x I _n IF> = 0.050 ... 40.000 x I _n UF< = 0.50 ... 0.900 x U _n IN> = 0.050 ... 40.000 x I _n Op. Time after CB closed = 0.100 ... 5.000 sec
32	Directional power	Direction = forward, backward Nominal real power P _n = 1 ... 1000 000 kW (primary values) Max. reverse load P> = 1 ... 50% x P _n Op. time after CB closed = 1.0 ... 1000.0 s

6.3.

Configuration restriction

There are some limitations that must be respected during the REF 542plus configuration.

- At most 24 protection functions can be configured inside the unit.
- A protection function can activate only one single direct channel.
- The number of direct channel is limited to 24.
- The configuration cycle time must be below 30 ms, to guarantee the proper working of the unit.
- At most 1000 wires can be drawn and the connections are limited to 512.
- Only one store object can be configured. (The store object allows storing binary data between a power failure and the next start-up, see the programming manual for more details).

- At most 62 switching objects can be configured (a switching object is used to represent a primary object like a circuit breaker, a contactor and so on.)
- At most 15 energy counters can be configured.
- At most 10 analog threshold objects per analog input can be configured (analog threshold objects allow to undertake some actions depending upon the level of voltage and current, see the programming manual for more details).

LCD and HMI

- At most ten icons can be displayed on the LCD.
- At most eight switching devices icons can be displayed on the LCD.
- When binary I/O modules with mechanical relays are used, a maximum of seven switching devices can be controlled.
- At most, 40 lines can be drawn.
- At most 32 signaling LEDs organized in 4 pages can be configured.
- At most 48 control objects can be installed.
- At most 48 timer functions can be controlled.
- At most 32 command object for sequencer starting can be applied

6.4.

Binary inputs and outputs

Binary input and output modules are available in two main versions: with electromechanical relays and with static outputs (power transistor types). For both of them, binary inputs are of the same type, insulated with optic couplers.

Inside a REF 542plus unit, only modules of the same type have to be present. It is not possible to have both static and electromechanical modules.

6.4.1.

BIO module with mechanical output relays (version3)

Binary input and output modules type BIO3 are available in several versions.

- Voltage range low, with inputs able to withstand a voltage range from 19 ... 72 V DC. The input threshold activation level is 14 V DC.
- Voltage range high, with inputs able to withstand a voltage range from 88 ... 132 V DC. The input threshold activation level is 50 V DC.
- Voltage range high, with inputs able to withstand a voltage range from 88 ... 132 V DC. The input threshold activation level is 72 V DC.
- Voltage range high, with inputs able to withstand a voltage range from 176 ... 264 V DC. The input threshold activation level is 143 V DC.

All the above-mentioned modules can be equipped with an optional static output (power transistor) on binary output 7, instead of the normal electromechanical contact. This static output is usually needed to feed external energy meters with pulses.

To make wiring easier, there are also module versions for the wide voltage range (high and low) available with the binary inputs minus (-) connected together on the module by an internal line.

The following Table 6.4.1.-1 shows the main features

Table 6.4.1.-1 BIO3 module features

14 input channels Hardware-fixed filter time 1 ms. Additional filter time can be configured in software.	Possible auxiliary voltage ranges:	19... 72 V DC (threshold 14 V DC)
		88 ... 132 V DC (threshold 50 V DC)
		88 ... 132 V DC (threshold 72 V DC)
		176 ... 264 V DC (threshold 143 V DC)
6 power outputs (channels BO 1 to 6)	Maximum operating voltage	250 V AC/DC
	Make current	8 A
	Load current	6 A
	Breaking capacity	1 contact 70 W, 2 contacts in series 130 W at L/R ≤ 40 ms and 10.000 operations
	Operating time	8 ms
2 signal outputs (BO7 and BO8) and 1 watchdog output (WD)	Maximum operating voltage	250 V AC/DC
	Load current	2 A
	Operating time	8 ms
Optional: 1 static output on BO7	Maximum operating voltage	250 V DC
	Make current	1.5 A peak
	Load current	0.7 A continuous
	Operating time	1 ms
1 coil supervision circuit on BO2	Coil OK when impedance below 10 Ω	

6.4.2.

BIO module with static outputs

The technical data for the binary input and output module with static outputs are listed in Table 6.4.2.-1. This module is full range and covers the complete voltage range from 48 up to 265 VDC.

Table 6.4.2.-1 Technical data for the binary input and output module with static outputs

14 inputs (BI 1–14). Hardware-fixed filter time 5 ms. Additional filter time can be configured in software.	Auxiliary voltage range:	48 to 265 V DC (Threshold 356 V DC)
3 power outputs (BO1,2 and b7)	Operating voltage	48 to 250 V DC
	Make current	64 A
	Load current	16 A
	Operating time	1 ms

4 power outputs (BO3...6)	Operating voltage	48 to 250 V DC
	Make current	120 A
	Load current	31 A
	Operating time	1 ms
2 signal outputs (BO8,9) and 1 watchdog output (WD)	Operating voltage	48 to 250 V DC
	Make current	1.5 A (100 ms)
	Ron	1.06 Ω
	Roff	40 MΩ
2 coil supervision circuits on BO1 and BO2 channels	Coil OK when impedance below 10 kΩ	

6.5.

Interfaces

HMI control unit

- Serial infrared (IrDa)/electrical RS-232 interface to a PC (at the front)
- Electrically isolated RS-485 standard interface to the base unit (at the rear)
- Electrical standard-interface RJ-45 for Modbus TCP and/or the embedded WEB server
- Power supply

Base unit

- Electrically isolated RS-485 standard interface to the HMI
- RS-232 standard service interface (service port for updating configuration and firmware)
- Ethernet TCP/IP port
- Power supply

0/4 ... 20 mA analog output module (optional)

- Four output channels 0 to 20 mA or 4 to 20 mA, freely configurable.

4 ... 20 mA analog input module (optional)

- Six input channels 4 ... 20 mA

Communication to a station automation system (optional)

- SPA, optical plastic fiber interface with a snap-in type connector; or glass fiber (multi-mode) with F-SMA or ST connectors
- LON (according to ABB LAG1.4), glass fiber (multi-mode) optical interface with ST connectors
- IEC 60870-5-103 with extension according to VDN guidelines for controlling, glass fiber (multi-mode) optical interface with ST connectors

- Modbus RTU/SPA bus electrical interface with two galvanically insulated SPA-bus RS-485 ports or optical interface with four standard ST connectors for glass fiber (multi-mode)
- IEC 61850 electrical interface with two RJ45 connectors or an optical interface with two LC connectors.

Ethernet Interface

- Standard RJ45 connector on the main module

CAN Open (optional and only for ABB switchgear companies).

- Open-style connector compliant with CAN Open standard and ISO11898

Input for time synchronization (optional, the supported protocol is IRIG, format B000, B002, B003).

- Glass fiber
- Wavelength: 820 nm
- Max distance: 1500 m
- Connector type: ST

6.6.

Power supply

Table 6.6.-1 Base unit

Rated voltage 110 V DC	Operative range 70% to 120% of 110 V DC
Rated voltage 220 V DC	Operative range 70% to 120% of 220 V DC
Rated voltage 48 VDC to 220 V DC	Operative range 80% of 48 V DC to 120% of 220 V DC
Power consumption	≤ 20 W (Typical, 2 BIOs)
Inrush current	Module 750 168: 10 A, 1 ms; 35 A, 100 μs Module 750 126: 8.3 A, 4 ms; 21 A, 100 μs
Admissible ripple	Less than 10%

Table 6.6.-2 HMI

Rated voltage 48 V DC to 90 V DC	Operative range 85% of 48 V DC to 110% of 90 V DC
Rated voltage 110 V DC to 240 V DC	Operative range 85% of 110 V DC to 110% of 240 V DC
Power consumption	≤ 6 W backlight off and < 10W backlight on
Admissible ripple	Less than 10%

6.7. Environmental conditions

Table 6.7.-1 Environmental conditions

Ambient operation temperature	-10 + 55 °C
Ambient transport and storage temperature	-25 +70 °C
Ambient humidity	Up to 95% without condensation
Altitude	< 1.000m a.s.l

6.8. Protection degree

Base unit

- Housing: IP 20

HMI

- Front: IP 44 (IP 54 HMI version with cover)
- Rear: IP 20

HMI with cover

- Front: IP 54
- Rear: IP 20

6.9. Tests

Type test

Detailed information on type tests are listed in the document: REF 542plus. Type test certificate, 1MRS756443.

Protection functions

Protection functions are type tested according to IEC 60255 standard series.

Electromagnetic compatibility

All relevant tests are according to the following standard series:

- IEC 60255 for electromagnetic compatibility and product standard
- EN 61000 for electromagnetic compatibility
- EN 50263 for measuring relays and protection equipment
- EN 60694 + IEC 60694AMD 12000 for common specifications for high-voltage switchgear and control gears

Insulation resistance

Greater than >100 MΩ at 500 V DC.

Mechanical robustness

According to IEC 60255-21-1.

Climatic conditions

Cold test according to IEC 60068-2-1.

Dry heat test according to IEC 60068-2-2.

Certifications**ATEX**

The REF 542plus unit, when used as a motor protection, can optionally comply with the directive 94/9/EC from the European Community for explosives environments. This directive defines how motor protection units behave in potentially explosive environment. The EC type certification number from PTB (Physikalisch Technische Bundesanstalt) is PTB 02 ATEX 3000.

DNV

The REF 542plus unit, when used in marine application, can optionally comply with Det Norske Veritas' Rules for classification of ships, High Speed & Light Craft and Det Norske Veritas' Offshore Standards.

IEC 61850 Certificate level A

The conformance test has been performed according to IEC 61850-10 by KEMA Nederland.

7. Ordering

The different variants have their own specific order numbers that identify the type designation for the desired hardware and software combination.

The type code designation can be seen in Fig. 7.-1:

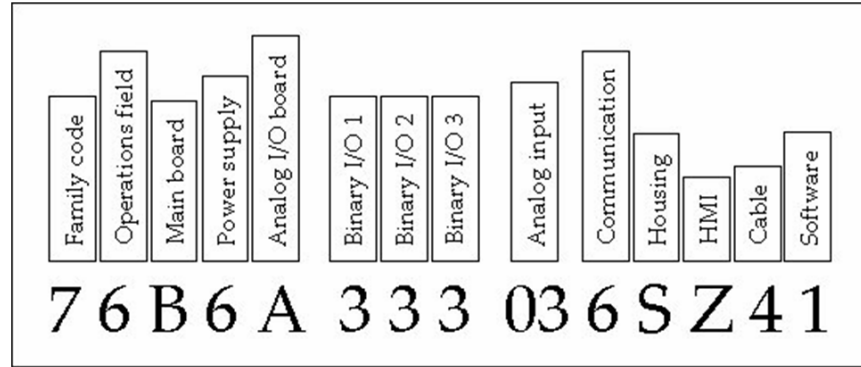

A060505

Fig. 7.-1 Type code designation for ordering REF 542plus

Each code is dedicated to a specific application or module. The description for each type code is listed in the following tables. The codes mentioned below are mostly used for the operations field of REF 542plus. The codes are slightly different in DNV and ATEX. Because ATEX certification is only valid for a specific version of REF 542plus, it is required to obtain a new certification after each release. The release 1.1 of ATEX certified units is REF 542plus with version V4C02, release 2.0 with version V4D02 and release 2.5 with version V4E04. For releases 1.1 and 2.0 the REF 542plus unit is delivered with the previous HMI V4 and for release 2.5 with the new HMI V5. Order the DNV certifies for marine application. Note that the DNV version can only deliver with the previous HMI V4.

7 6 B 6 A 3 3 3 0 3 6 S Z 4 1

Table 7.-1 Family code

NUMBER	CODE	NAME	DESCRIPTION
7		REF 542plus	Product family for the feeder terminal unit REF 542plus

7 6 B 6 A 3 3 3 0 3 6 S Z 4 1

Table 7-2 Application areas

NUMBER	CODE	NAME	DESCRIPTION
6		REF 542plus	Normal operation
A		REF 542plus DNV	Marine and offshore application
B		REF 542plus ATEX-1	Protection of motor in an explosive area (Release 1.1)
D		REF 542plus ATEX-2	Protection of motor in an explosive area (Release 2.0)
F		REF542plus ATEX-2.5	Protection of motor in an explosive area (Release 2.5)

76B6A333036SZ41

Table 7-3 Mainboard versions

NUMBER	CODE	NAME	DESCRIPTION
B	751021/802	Basic	Version with RJ 45 Ethernet port
S	751021/803	Standard	Version basic with additional IRIG B and CAN interface
F	751021/801	Full	Version standard with additional optical links
A	014629/802	Basic	Version with RJ 45 Ethernet port
E	014629/803	Standard	Version basic with additional IRIG B and CAN interface
C	014629/801	Full	Version standard with additional optical links

76B6A333036SZ41

Table 7-4 Power supply versions

NUMBER	CODE	NAME	DESCRIPTION
1	750126/801	$U_n = 110 \text{ V DC}$	Operative range 70% to 120% of 110 V DC
2	750126/802	$U_n = 220 \text{ V DC}$	Operative range 70% to 120% of 220 V DC
3	750168/801	$U_n = 48 - 220 \text{ V DC}$	Operative range 80% of 48 V DC to 120% of 220 V DC
6	750168/802	$U_n = 48 - 220 \text{ V DC}$	Marine application with operative range 80% of 48 V DC to 120% of 220 V DC

76B6A333036SZ41

Table 7.-5 Analog I/O modules

NUMBER	CODE	NAME	DESCRIPTION
N	none	No analog input or output	Empty analog I/O module slot
A	750211/801	Analog input module 4-20 mA	Analog input module for 4-20 mA installed, up to 6 inputs
B	750237/801	Analog output module 0 (4)-20 mA	Analog output module for 0(4)-20 mA installed, up to 4 outputs

7 6 B 6 A 3 3 3 0 3 6 S Z 4 1

Table 7.-6 Binary I/O modules

NUMBER	CODE	NAME	DESCRIPTION
1	701952/801	Static I/O	Application in GIS panel with coil supervision through a control continuity check
2	701952/802	Static I/O - without control continuity check	Static I/O without control continuity check
5	750132/801	Binary I/O3 - 19-72 V/14 V DC, standard	Standard version with a 14 V DC threshold value for an application in an auxiliary circuit with a DC voltage range of 19-72 V DC
6	750132/803	Binary I/O3 - 19-72 V/14 V DC, with static channel	As no. 5 + one static output channel for energy metering
7	750161/801	Binary I/O3 - 19-72 V/14 V DC, interconnected input, standard	As no. 5 + interconnected binary inputs
8	750161/803	Binary I/O3 - 19-72 V/14 V DC, interconnected input, with static channel	As no. 5 + interconnected binary inputs + one static output channel for energy metering
9	750132/802	Binary I/O3 - 88-132 V/50 V DC, standard	Standard version with a 50V DC threshold value for an application in an auxiliary circuit with a DC voltage range of 88-132 V DC
A	750132/804	Binary I/O3 - 88-132 V/50 V DC, with static channel	As no. 9 + one static output channel for energy metering
B	750161/802	Binary I/O3 - 88-132 V/50 V DC, interconnected input, standard	As no. 9 + interconnected binary inputs
C	750161/804	Binary I/O3 - 88-132 V/50 V DC, interconnected input, with static channel	As no. 9 + interconnected binary inputs + one static output channel for energy metering
D	750132/805	Binary I/O3 - 88-132 V/72 V DC, standard	Standard version with a 72 V DC threshold value for an application in an auxiliary circuit with a DC voltage range of 88-132 V DC

NUMBER	CODE	NAME	DESCRIPTION
E	750132/806	Binary I/O3 - 88-132 V/ 72 V DC, with static channel	As no. D + one static output channel for energy metering
F	750132/807	Binary I/O3 - 176-264 V/ 143 V DC, standard	Standard version with a 143 V DC threshold value for an application in an auxiliary circuit with a DC voltage range of 176-264 V DC
G	750132/808	Binary I/O3 - 176-264 V/ 143 V DC, with static channel	As no. F + one static output channel for energy metering

Static I/O: 14 inputs, 7 power outputs, 2 signal outputs and 1 watchdog output.

BIO 3: 14 inputs, 6 power outputs, 2 signal outputs and 1 watchdog output.

76B6A333036SZ41

Binary IO Slot 2: Version of binary I/O. Possible selection depends on the selected version of the binary I/O 1. If no binary I/O is needed, the slot can remain empty. The corresponding code can be taken from Table 7.-6.

76B6A333036SZ41

Binary IO Slot 3: Version of binary I/O. Possible selection depends on the selected version of the binary I/O 1. If no binary I/O is needed, the slot can remain empty. The corresponding code can be taken from Table 7.-6.

76B6A333036SZ41

Analog Input XX: There are three different types of analog input versions which can be selected, as shown in the following tables:

Table 7.-7 Sensors

NUMBER	CODE	DESCRIPTION
01	750138/803	Analog Input sensors version

Table 7.-8 Mix of sensors and transformers

NUMBER	CODE	DESCRIPTION
10	750170/843	3 sensors + 3 sensors + 1 CT/0.2 A + 1 VT
11	750170/846	3 sensors + 3 VT + 1 CT/0.2 A + 1 VT
12	750170/847	3 sensors + 3 sensors + 1 CT
13	750170/851	3 sensors + 3 sensors + 1 CT + 1 VT
14	750170/852	3 sensors + 3 sensors + 1 CT/0.2 A
15	750170/853	3 sensors + 3 sensors + 1 VT + 1 VT

NUMBER	CODE	DESCRIPTION
16	750170/854	3 sensors + 3 CT + 1 CT/0.2 A + 1 VT
17	750170/855	3 sensors + 3 CT + 1 CT/0.2 A + 1 CT/0.2 A

Table 7.-9 Mix of transformers

NUMBER	CODE	DESCRIPTION
30	750170/804	3 CT + 3 VT + 1 CT/0.2 A + 1 VT
31	750170/806	3 VT + 3 VT + 1 CT/0.2 A + 1 CT/0.2 A
32	750170/807	3 CT + 3 CT
33	750170/809	3 CT + 3 CT + 1 CT/0.2 A + 1 VT
34	750170/812	3 VT + 3 VT + 1 VT
35	750170/817	3 CT + 3 VT + 1 CT
36	750170/819	3 CT + 3 VT + 1 CT + 1 VT
37	750170/821	3 CT + 0 VT + 1 CT
38	750170/822	3 CT + 0 VT + 1 CT/0.2 A
39	750170/825	3 CT + 3 VT + 1 CT/0.2 A + 1 CT/0.2 A
40	750170/826	3 CT + 3 VT + 1 VT + 1 VT
41	750170/827	3 CT + 3 CT + 1 CT + 1 CT
42	750170/828	3 CT + 3 CT + 1 CT + 1 VT
43	750170/824	3 CT + 3 VT + 1 CT + 1 CT

76B6A333036SZ41

Table 7.-10 Communication (with optional communication module)

NUMBER	CODE	NAME	DESCRIPTION
E	1VCR009634001	IEC 61850/MODBUS TCP with RJ45	
F	1VCR009634002	IEC 61850/MODBUS TCP with LC optical connector	
N	none	Without communication	No communication is requested
1	750079/801	Modbus RTU / SPA RS 485	
2	750079/802	Modbus RTU / SPA glass fibre with ST connectors	
3	701842/801	SPA plastic fibre	
4	701842/802	SPA glass fibre with SMA connectors	
5	701842/803	SPA glass fibre with ST connectors	
6	750071/801	LON - LAG 1.4	
7	750071/803	IEC 60870-5-103	

76B6A333036SZ41

Table 7.-11 Enclosure versions

NUMBER	CODE	NAME	DESCRIPTION
S	750154/801	Normal base unit	Normal version
W	750102/801	Wide base unit	Wide version

7 6 B 6 A 3 3 3 0 3 6 S Z 4 1

Table 7.-12 HMI variations

NUMBER	CODE	NAME	DESCRIPTION
N	none	No HMI	
A	007346/003	HMI V5 - IEC, auxiliary voltage 48-90 V DC	
B	007346/004	HMI V5 - IEC, auxiliary voltage 110-240 V DC	
C	007346/007	HMI V5 - IEC, external cover, auxiliary voltage 48-90 V DC	
D	007346/008	HMI V5 - IEC, external cover, auxiliary voltage 110-240 V DC	
E	007346/011	HMI V5 - IEC, Chinese, auxiliary voltage 48-90 V DC	
F	007346/012	HMI V5 - IEC, Chinese, auxiliary voltage 110-240 V DC	
G	007346/015	HMI V5 - IEC, Chinese, external cover, auxiliary voltage 48-90 V DC	
H	007346/016	HMI V5 - IEC, Chinese, external cover, auxiliary voltage 110-240 V DC	

7 6 B 6 A 3 3 3 0 3 6 S Z 4 1

Table 7.-13 Connection cables between the HMI and the base unit¹⁾

NUMBER	CODE	NAME	DESCRIPTION
N	none	No cable	No cable
1	750142/801	HMI cable - 1.8 m	1.8 m cable with corresponding connectors
2	750142/817	HMI cable - 2.5 m	2.5 m cable with corresponding connectors
3	750142/818	HMI cable - 3.5 m	3.5 m cable with corresponding connectors
4	750142/819	HMI cable - 4.5 m	4.5 m cable with corresponding connectors

Table 7.-14 Software licenses¹⁾

NUMBER	CODE	NAME	DESCRIPTION
1	1MRS090002	Software base license	Software level : Base
2	1MRS090003	Software high license	Software level : High
3	1MRS090004	Software basic low license	Software level : Basic Low
4	1MRS090005	Software basic license	Software level : Basic
5	1MRS090006	Software multi low license	Software level : Multi Low
6	1MRS090007	Software multi license	Software level : Multi
7	1MRS090008	Software differential license	Software level : Differential
8	1MRS090009	Software distance license	Software level : Distance

¹⁾A limitation of the protection functionality with a software license. Contact your local ABB organization for more detailed information. The software level Base can only be ordered by ABB switchgear companies. It is of the same level as the software level Distance.

Table 7.-15 SW tool licenses

Code	Description
1MRS 151022	REF 542plus Operating Tool CD
1MRS 151062	REF 542plus Configuration Tool CD

Use the key in Fig. 7.-2 to generate the type designation. The code numbers in the example are not complete and should be taken from the corresponding tables above.

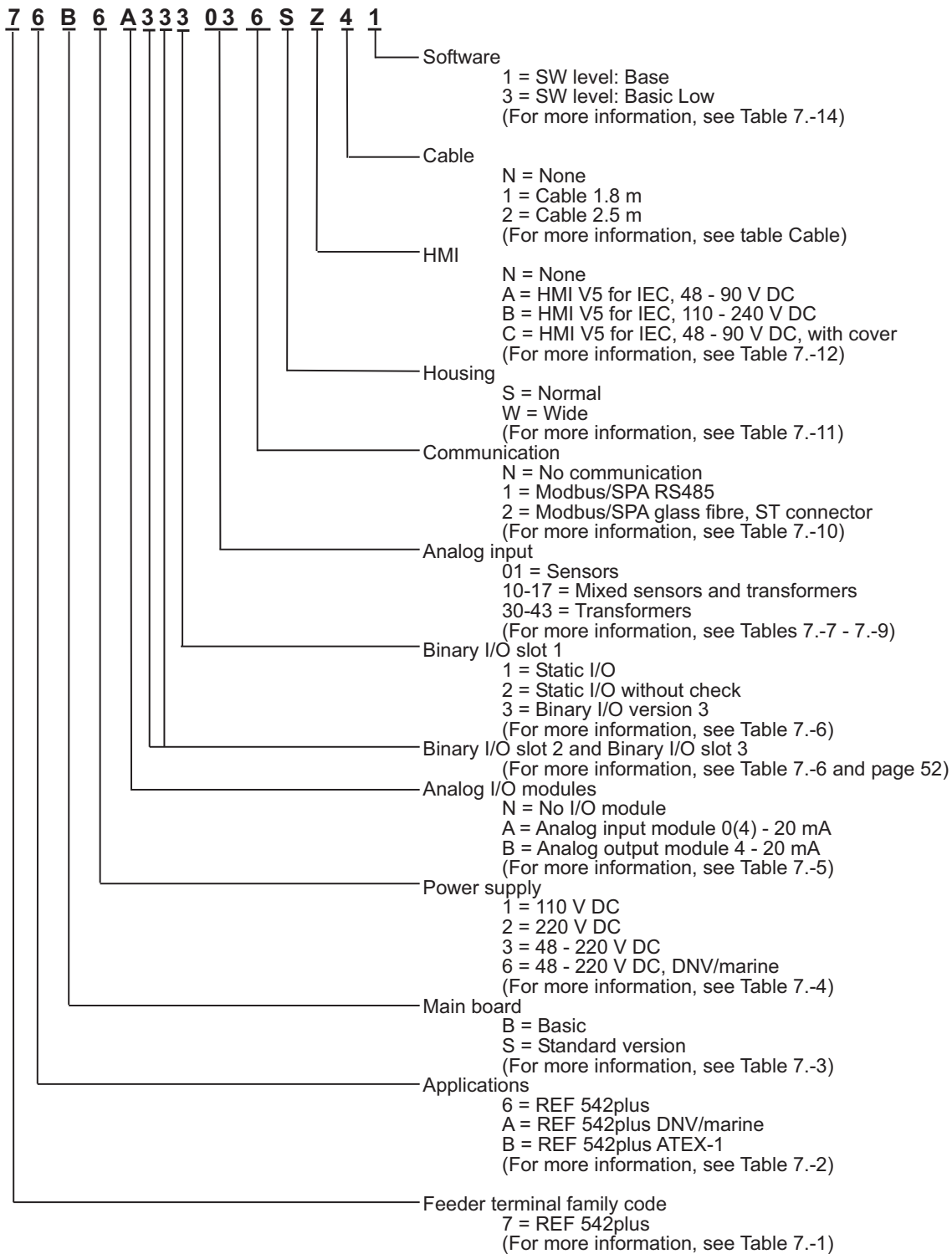

A060520_2

Fig. 7.-2 The key for generating the type designation

8. Connections

8.1. Connector plates

The pictures show the connections for REF 542plus both in the standard and wide housing versions. The wide housing version can house three binary input and output modules, the communication module, the 0/4 ... 20 mA analog output module or alternatively the 4 ... 20 mA analog input module. The standard housing version can house at most two binary input and output modules and alternatively the communication module or the analog output module.

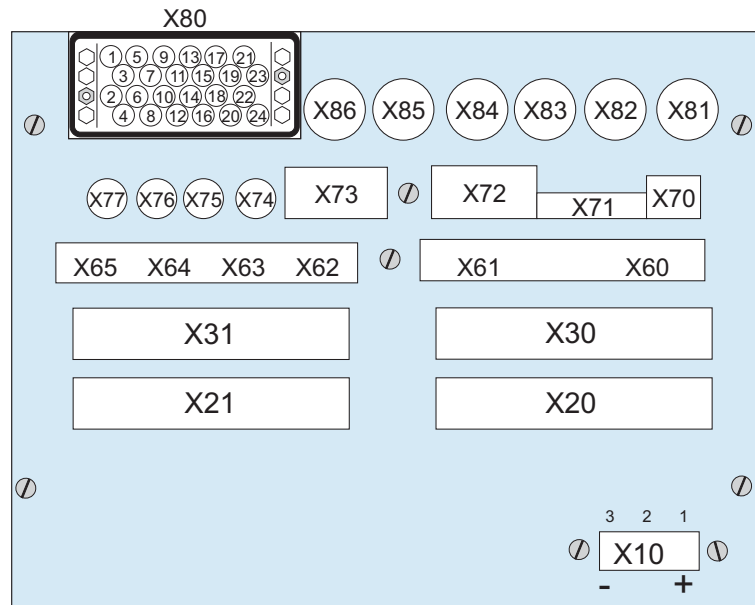

A051272

Fig. 8.1.-1 REF 542plus standard housing connections with mixed analog input connector and connector for the communication module

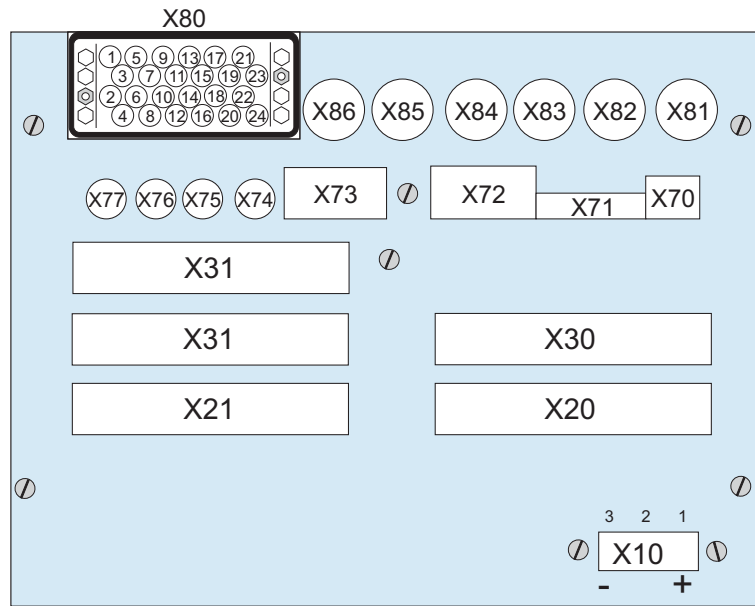

A051273

Fig. 8.1.-2 REF 542plus standard housing connections with mixed analog input connector and connector for the 0/4 ... 20 mA analog output module

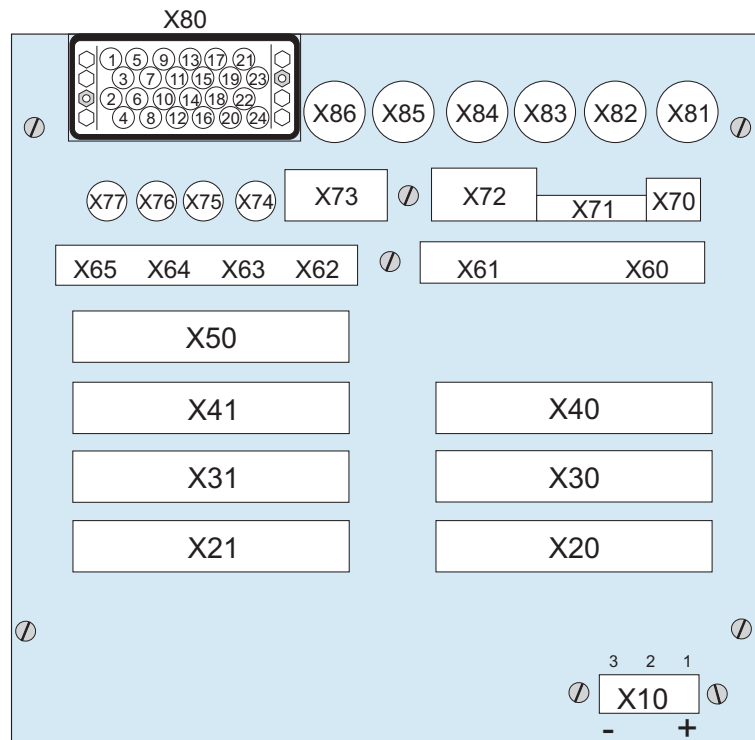

A051274

Fig. 8.1.-3 REF 542plus wide housing connections plate

The connectors meaning is explained in the following Table 8.1.-1. A few connectors have different meaning depending upon the used communication module type. Sensors connectors X87 and X88 are placed instead of X80 when only sensors are used.

Table 8.1.-1 **Meaning of connectors**

Connector	Meaning
X10	Base unit power supply
X20	First BIO, inputs
X21	First BIO, outputs
X30	Second BIO, inputs
X31	Second BIO, outputs
X40	Third BIO, inputs
X41	Third BIO, outputs
X50	Analog output 0/4 ... 20 mA or Analog input 4 ... 20 mA
X60	Modbus RS-485, channel 2; COM L-COM I RX; SPABUS TX
X61	Modbus RS-485, channel 1; COM L-COM I TX; SPABUS RX
X62	Optical Modbus, RX channel 1
X63	Optical Modbus, TX channel 1
X64	Optical Modbus, RX channel 2
X65	Optical Modbus, TX channel 2
X66	Optical LC connector on the Ethernet module
X67	Optical LC connector on the Ethernet module
X68	Electrical RJ-45 connector on the Ethernet module
X69	Electrical RJ-45 connector on the Ethernet module
X70	Ethernet interface (RJ-45 on the mainboard)
X71	CAN interface
X72	RS-232 service port (null modem connection)
X73	Connection to HMI
X74	IRIG-B interface for time synchronization
X75	HSTD input
X76	HSTD input
X77	HSTD output
X80	Connector for CTs and VTs
X81	Sensor 1
X82	Sensor 2
X83	Sensor 3
X84	Sensor 4
X85	Sensor 5
X86	Sensor 6
X87	Sensor 7
X88	Sensor 8

The REF 542plus HMI connection is shown in Fig. 8.1.-4

- The X10 connector connects REF 542plus to the auxiliary voltage for the power supply.
 - Connector type: Weidmuller SLA2/90B3.2SNOR
- The X20 connector connects REF 542plus to the base unit.
 - Connector type: D-SUB9 FCT F09P5G2-K216

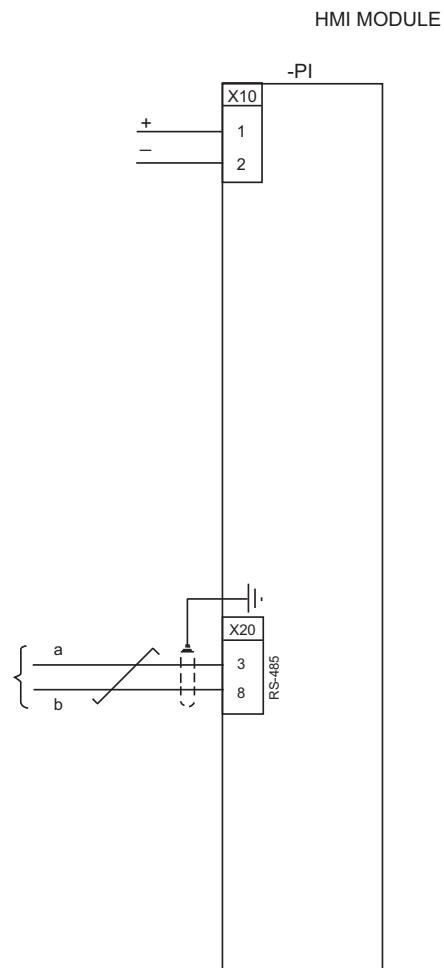

A051275

Fig. 8.1.-4 REF 542plus HMI connection

Analog input connections

The analog input connector changes when conventional instrument transformers, sensors or mixed combinations have to be connected. When sensors are used, they are connected with CPE type connectors.

X81 corresponds to sensor 1, and X88 connects sensor 8. They can be indifferently current or voltage sensors. The choice is a software configuration inside the REF 542plus unit.

When conventional instrument transformers are in use, the connector looks like in the Fig. 8.1.-5

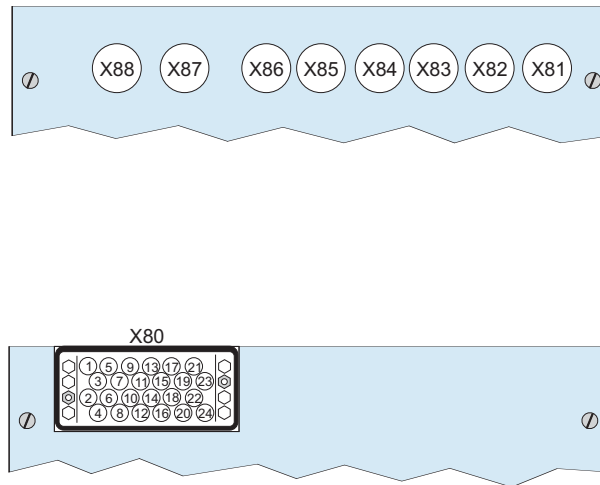

A051277

Fig. 8.1.-5 Connector for analog input module sensors and connector for conventional instrument transformers

8.2.

Binary input and output connections

Binary inputs and outputs modules use the following connectors:

- X20 (inputs), X21 (outputs) for the first module
- X30 (inputs), X31 (outputs) for the second module
- X40 (inputs), X41 (outputs) for the third module, available with the wide case only

The Fig. 8.2.-1 shows the connection diagram for the binary inputs and outputs module BIO3.

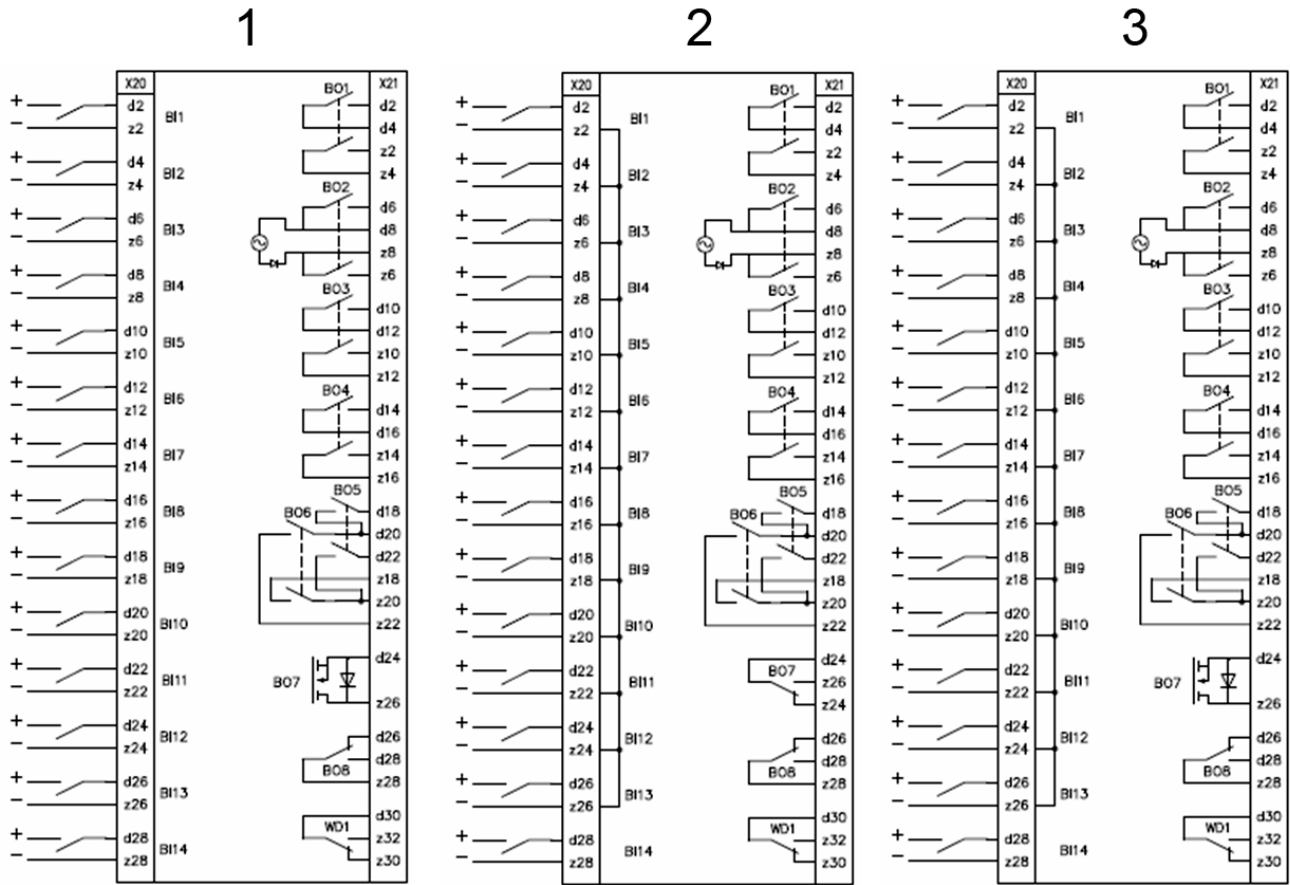

A070134

Fig. 8.2.-1 Binary inputs and outputs module BIO3

- 1: BIO3 standard
- 2: BIO3 with 1 static channel
- 3: BIO3 with interconnected inputs

The following Fig. 8.2.-2 shows the binary inputs and outputs module called Static I/O.

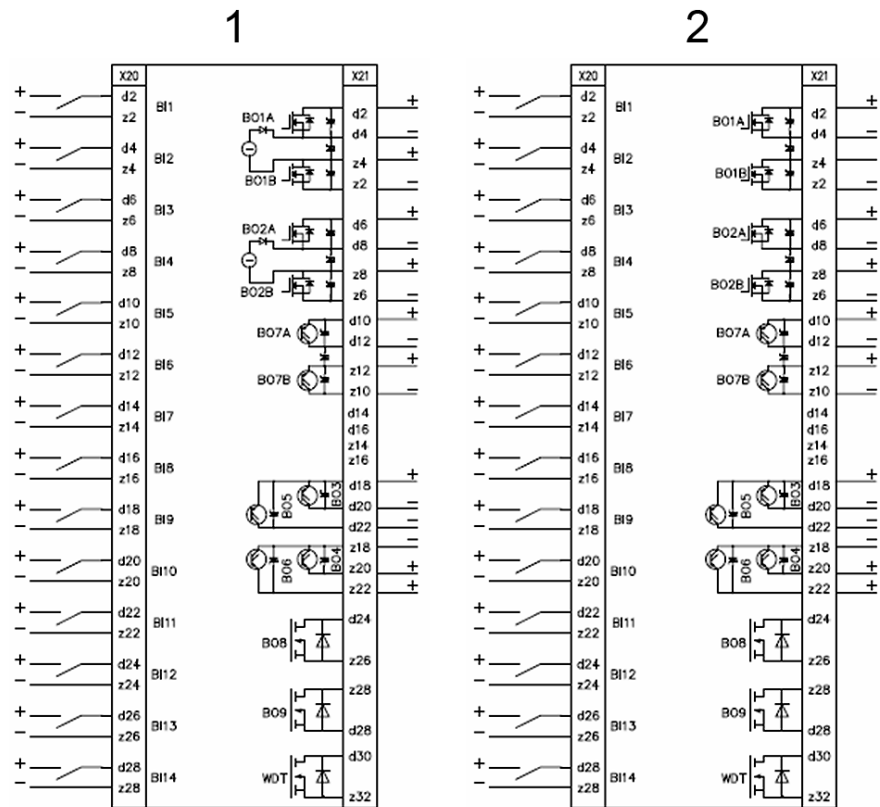

A070135

Fig. 8.2.-2 Binary inputs and outputs module Static I/O

- 1: Standard static I/O
- 2: Static I/O without control continuity check

In the binary inputs and outputs module BIO3, the trip coil supervision is located in BO2. Binary outputs BO7 and BO8 are exchange contacts, normally used for signalling. WD1 is the watchdog contact. In the static output module, there are two trip coil supervision circuits in BO1 and BO2.

8.3. Typical connection schemes

Some exemplary connection schemes are reported below. Many others are possible.

8.3.1. Generic outgoing feeder

This picture represents the typical connection scheme for outgoing feeders, when both voltage and current protections are required. There is also a current balance transformer for earth-fault current sensing. Analog input channel 8 is not used.

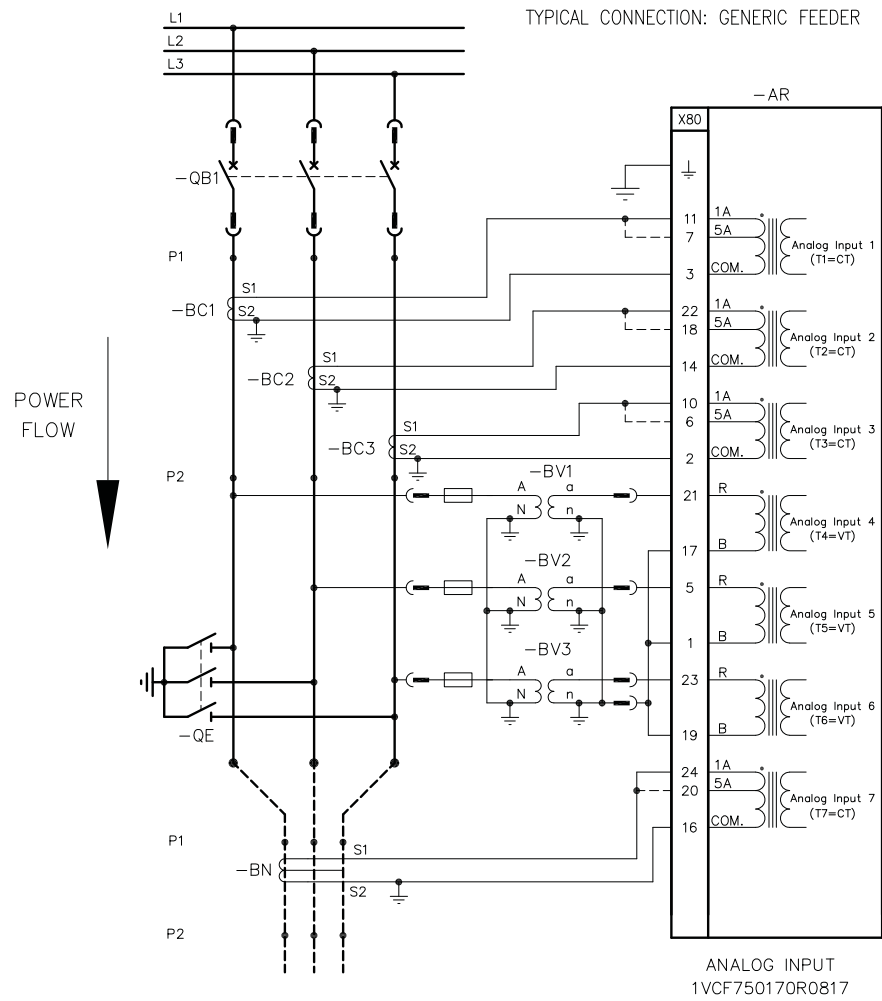

Fig. 8.3.1.-1 Generic outgoing feeder

A070120

8.3.2. Feeder with differential protection

The schematic diagram below shows the connection for a power transformer feeder with differential, earth-fault and restricted earth fault protection.

The used analog input board has 8 inputs for currents. The first 6 channels are used for the differential protection; channel 7 is used for the restricted earth fault protection and channel 8 for the earth protection.

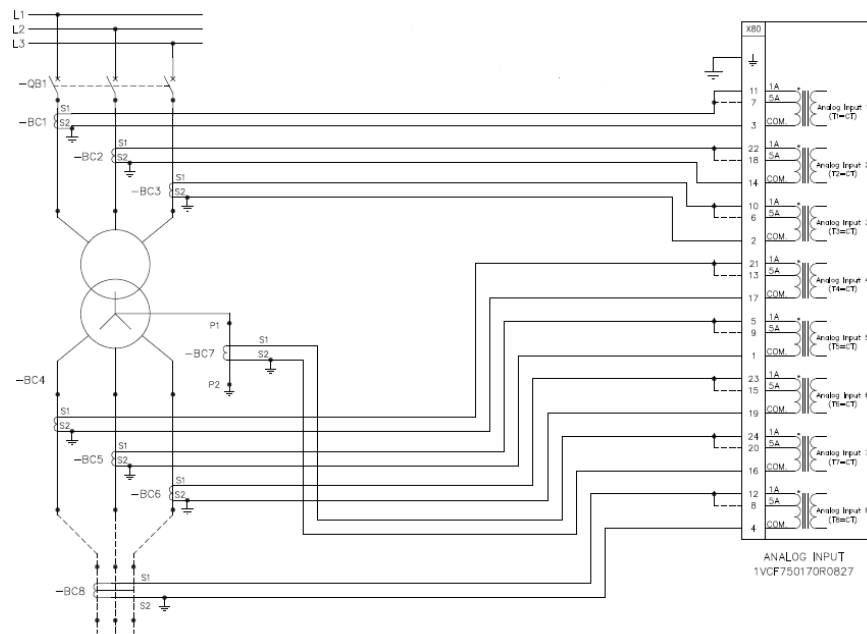

A051283

Fig. 8.3.2.-1 Power transformer differential protection

8.3.3. Incoming feeder with synchrocheck

The Fig. 8.3.3.-1 shows a possible connection diagram for a generic incoming feeder with synchrocheck function on the busbar.

Channels 1, 2, 3 are used for current sensing and Channels 4, 5, 6 are used for phase to earth voltage measurements and protection of the incoming feeder. Channel 7 is used for the residual current for earth fault protection while channel 8 is used for busbar phase-to-phase voltage to perform the synchrocheck.

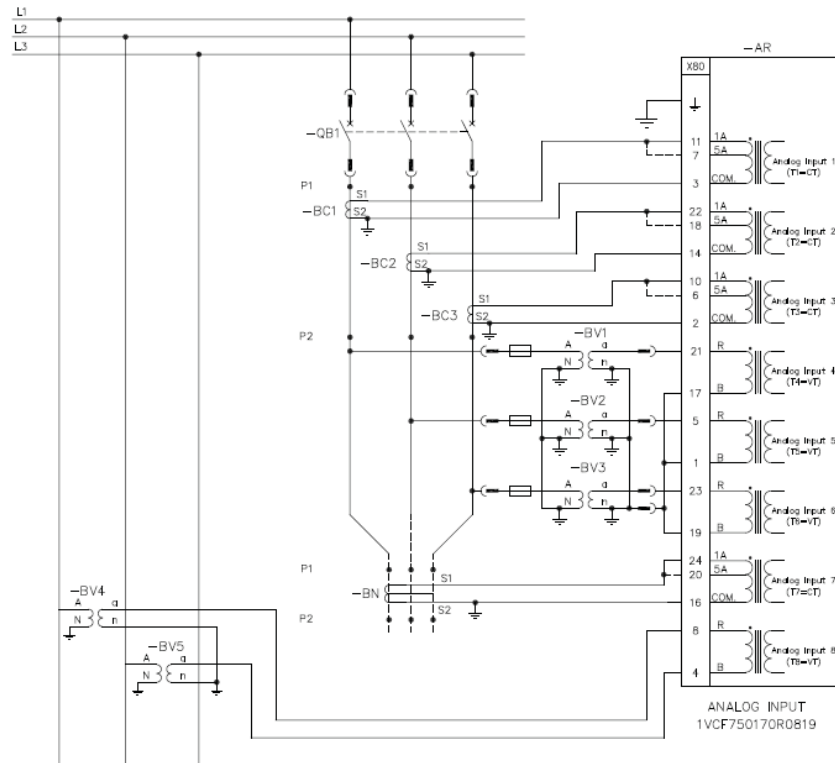

Fig. 8.3.3.-1 Incoming feeder with synchrocheck capability

A051284

9. Abbreviations

Abbreviation	Description
CAN	Controller area network
CB	Circuit-breaker
CT	Current transformer
DC	Direct current
EMC	Electromagnetic compatibility
GIS	Gas insulated switchgear
GPS	Global positioning system
HMI	Human-machine interface
I/O	Binary input and output
IDMT	Inverse definite minimum time characteristic
LAG	Lon application guide
LCD	Liquid crystal display
LED	Light-emitting diode
LON	Local operating network
LV	Low voltage
MC	Micro controller
MV	Medium voltage
PC	Personal computer
PTT	Protection transfer trip scheme by comparison of the related signals
RMS	Root mean square
RTU	Remote terminal unit
SLD	Single-line diagram
SPA	Data communication protocol developed by ABB
ST	Straight-tip; a connector type for fibre optic cable
TCP	Transmission Control Protocol
VDEW	Association of German Electrical Utilities
VDN	Association of German Electrical Utilities
VT	Voltage transformer



ABB Oy
Distribution Automation
P.O.box 699
FI-65101 Vaasa
FINLAND
+358 10 22 11
+358 10 22 224 1094
<http://www.abb.com/substationautomation>