

SIEMENS

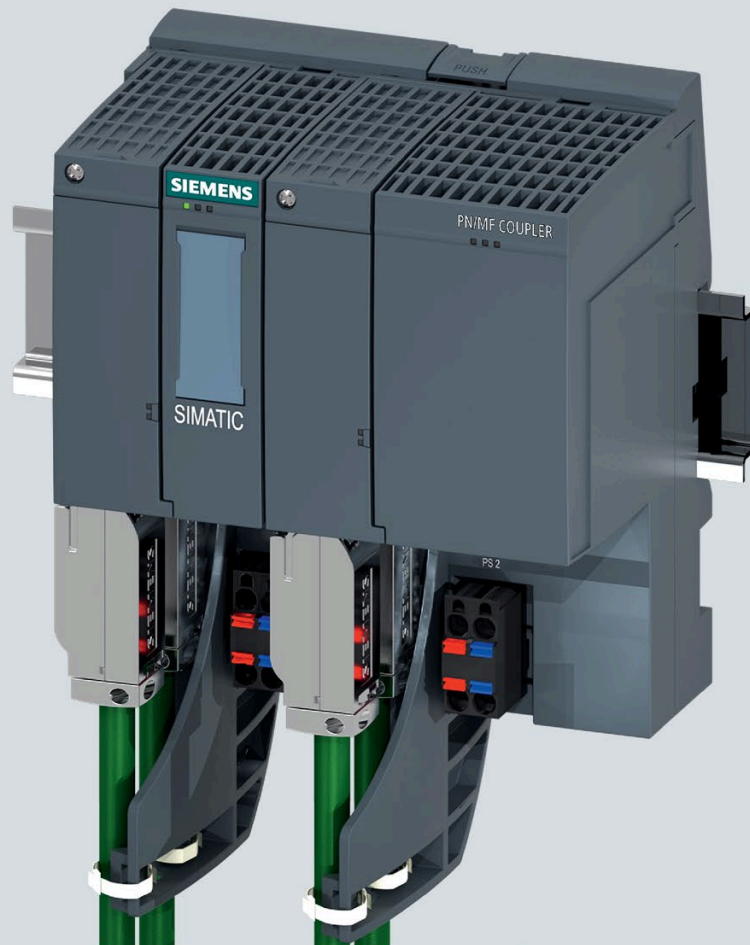

Installation and operating manual

SIMATIC

Bus links

PN/MF Coupler

Edition

07/2020

support.industry.siemens.com

SIEMENS

SIMATIC

Bus couplers PN/MF Coupler

Hardware Installation and Operating Manual

<u>Preface</u>	
<u>Documentation guide</u>	1
<u>Product overview</u>	2
<u>Assembling</u>	3
<u>Connecting</u>	4
<u>PROFINET IO</u>	5
<u>EtherNet/IP</u>	6
<u>Operation and maintenance</u>	7
<u>Technical specifications</u>	8
<u>Dimension drawing</u>	A
<u>Article numbers and accessories</u>	B
<u>Response times</u>	C
<u>Safety-related symbols</u>	D

Legal information

Warning notice system

This manual contains notices you have to observe in order to ensure your personal safety, as well as to prevent damage to property. The notices referring to your personal safety are highlighted in the manual by a safety alert symbol, notices referring only to property damage have no safety alert symbol. These notices shown below are graded according to the degree of danger.

DANGER

indicates that death or severe personal injury **will** result if proper precautions are not taken.

WARNING

indicates that death or severe personal injury **may** result if proper precautions are not taken.

CAUTION

indicates that minor personal injury can result if proper precautions are not taken.

NOTICE

indicates that property damage can result if proper precautions are not taken.

If more than one degree of danger is present, the warning notice representing the highest degree of danger will be used. A notice warning of injury to persons with a safety alert symbol may also include a warning relating to property damage.

Qualified Personnel

The product/system described in this documentation may be operated only by **personnel qualified** for the specific task in accordance with the relevant documentation, in particular its warning notices and safety instructions. Qualified personnel are those who, based on their training and experience, are capable of identifying risks and avoiding potential hazards when working with these products/systems.

Proper use of Siemens products

Note the following:

WARNING

Siemens products may only be used for the applications described in the catalog and in the relevant technical documentation. If products and components from other manufacturers are used, these must be recommended or approved by Siemens. Proper transport, storage, installation, assembly, commissioning, operation and maintenance are required to ensure that the products operate safely and without any problems. The permissible ambient conditions must be complied with. The information in the relevant documentation must be observed.

Trademarks

All names identified by ® are registered trademarks of Siemens AG. The remaining trademarks in this publication may be trademarks whose use by third parties for their own purposes could violate the rights of the owner.

Disclaimer of Liability

We have reviewed the contents of this publication to ensure consistency with the hardware and software described. Since variance cannot be precluded entirely, we cannot guarantee full consistency. However, the information in this publication is reviewed regularly and any necessary corrections are included in subsequent editions.

Preface

Purpose of this manual

This manual provides all the necessary information for configuring, installing, connecting and commissioning the PN/MF Coupler.

Required basic knowledge

The following knowledge is required in order to understand the manual:

- General knowledge of automation technology
- Knowledge of the use of computers or PC -like tools (e.g. programming devices) under the Windows operating system.
- Knowledge of working with STEP 7 You can find information on this topic in the STEP 7 online help.
- Knowledge of working with EtherNet/IP

Scope of the manual

This manual is valid for PN/MF Coupler V5.0 with article number 6ES7158-3MU10-0XA0.

This manual contains a description of the components that were valid at the time the manual was published. We reserve the right to include up-to-date Product Information with new components and new versions of components.

Recycling and disposal

The PN/MF Coupler is low in contaminants and can therefore be recycled. For environmentally friendly recycling and disposal of your old equipment, contact a certified electronic waste disposal company and dispose of the equipment according to the applicable regulations in your country.

Security information

Siemens provides products and solutions with industrial security functions that support the secure operation of plants, systems, machines and networks.

In order to protect plants, systems, machines and networks against cyber threats, it is necessary to implement – and continuously maintain – a holistic, state-of-the-art industrial security concept. Siemens' products and solutions constitute one element of such a concept.

Customers are responsible for preventing unauthorized access to their plants, systems, machines and networks. Such systems, machines and components should only be connected to an enterprise network or the internet if and to the extent such a connection is necessary and only when appropriate security measures (e.g. firewalls and/or network segmentation) are in place.

For additional information on industrial security measures that may be implemented, please visit (<https://www.siemens.com/industrialsecurity>).

Siemens' products and solutions undergo continuous development to make them more secure. Siemens strongly recommends that product updates are applied as soon as they are available and that the latest product versions are used. Use of product versions that are no longer supported, and failure to apply the latest updates may increase customers' exposure to cyber threats.

To stay informed about product updates, subscribe to the Siemens Industrial Security RSS Feed visit (<https://www.siemens.com/industrialsecurity>).

Siemens Industry Online Support

You can find current information on the following topics quickly and easily here:

- **Product support**

All the information and extensive know-how on your product, technical specifications, FAQs, certificates, downloads, and manuals.

- **Application examples**

Tools and examples to solve your automation tasks – as well as function blocks, performance information and videos.

- **Services**

Information about Industry Services, Field Services, Technical Support, spare parts and training offers.

- **Forums**

For answers and solutions concerning automation technology.

- **mySupport**

Your personal working area in Industry Online Support for messages, support queries, and configurable documents.

This information is provided by the Siemens Industry Online Support in the Internet (<https://support.industry.siemens.com>).

Industry Mall

The Industry Mall is the catalog and order system of Siemens AG for automation and drive solutions on the basis of Totally Integrated Automation (TIA) and Totally Integrated Power (TIP).

You can find catalogs for all automation and drive products on the Internet (<https://mall.industry.siemens.com>) and in the Information and Download Center.

Table of contents

	Preface	3
1	Documentation guide	9
2	Product overview	12
2.1	Area of application and function	12
2.2	MultiFieldbus engineering	14
2.3	Properties.....	16
2.4	Operator controls and display elements	19
2.5	Detect active fieldbus.....	20
3	Assembling	21
3.1	Assembly rules.....	21
3.2	Installing the PN/MF Coupler	22
3.3	Removing the PN/MF Coupler.....	23
3.4	Applying labeling strips.....	23
3.5	Applying reference identification labels.....	24
3.6	Strain relief.....	25
4	Connecting	27
4.1	Electrical isolation and grounding	27
4.1.1	Introduction	27
4.1.2	General operating rules and regulations.....	27
4.2	Connections	29
4.3	Connecting the power supply	30
4.4	Connecting the SIMATIC BusAdapter	33
4.5	Block diagram.....	34
5	PROFINET IO	35
5.1	PROFINET IO functions.....	35
5.1.1	Device replacement	35
5.1.2	Media redundancy (MRP).....	36
5.1.3	Docking station.....	37

5.2	Configuring, parameter assignment and commissioning with PROFINET IO	39
5.2.1	Configuring and commissioning the PN/MF Coupler (Overview).....	39
5.2.2	Requirements	39
5.2.3	Assignment of the modules	40
5.2.4	Configuring the PN/MF Coupler with GSD file	41
5.2.5	Configuring the PN/MF Coupler with STEP 7 TIA Portal	42
5.2.5.1	Configuring the PN/MF Coupler with STEP 7 TIA Portal	42
5.2.5.2	Example: Configuring with STEP 7 TIA Portal	43
5.2.5.3	Generating a GSD file with STEP 7 TIA Portal.....	44
5.2.6	Parameters	45
5.2.7	Commissioning the PN/MF Coupler	47
5.2.8	Identification data	48
5.3	PROFINET IO interrupts, diagnostics, error messages and system events	50
5.3.1	Diagnostics via LED displays	50
5.3.2	Diagnostics by user program	53
5.3.2.1	Extended channel diagnostics	53
5.3.2.2	Interrupts	55
5.3.2.3	Diagnostics readout	56
5.3.2.4	Data validity display	56
5.3.2.5	STOP of the IO controller and recovery of the IO device	57
5.3.3	Reading service data	57
6	EtherNet/IP.....	58
6.1	EtherNet/IP functions	58
6.1.1	EtherNet/IP	58
6.2	Integration into the automation system	58
6.2.1	Overview	58
6.2.2	Configuring with MFCT	60
6.2.2.1	Settings.....	60
6.2.2.2	Assigning network parameters.....	61
6.2.2.3	Resetting the MF device.....	62
6.2.2.4	Creating new MultiFieldbus project in MFCT.....	63
6.2.2.5	Open MultiFieldbus project in MFCT.....	64
6.2.2.6	Selecting a station	65
6.2.2.7	Configuring a station	67
6.2.2.8	Parameter assignment of the station	69
6.2.2.9	Transfer the configuration	70
6.2.3	Configuration in the engineering system.....	72
6.2.3.1	Configuration in the engineering system.....	72
6.2.3.2	Import EDS station description	72
6.2.3.3	Importing a user-defined type (UDT)	72
6.2.3.4	Configuring the interface module	73
6.2.3.5	Configuring the module from the user program	73
6.2.3.6	I/O data mapping	75
6.2.3.7	Example of I/O data mapping for I/O data alignment Byte	76
6.2.3.8	Example of I/O data mapping for I/O data alignment Word.....	77
6.3	Diagnostics.....	80
6.3.1	Status and error displays for EtherNet/IP.....	80
6.3.2	Reading diagnostics via CIP EtherNet/IP	84

6.4	Supported CIP objects for EtherNet/IP	86
6.4.1	Identity Object.....	86
6.4.2	Assembly Object	88
6.4.3	Connection Manager Object	90
6.4.4	TCP/IP Interface Object.....	91
6.4.5	EtherNet Link Object.....	95
6.4.6	LLDP Management Object.....	100
6.4.7	LLDP Data Table Object	101
6.4.8	Param Object.....	104
7	Operation and maintenance	106
7.1	Updating firmware via PROFINET IO	106
7.2	Replacing a defective PN/MF Coupler.....	107
7.3	Reset to factory settings.....	108
7.4	Maintenance and repair	109
8	Technical specifications.....	110
8.1	General technical specifications	110
8.1.1	Introduction	110
8.1.2	Standards and approvals.....	110
8.1.3	Electromagnetic compatibility.....	118
8.1.4	Transport and storage conditions	120
8.1.5	Mechanical and climatic ambient conditions for operation	121
8.1.6	Specifications for insulation tests, safety class and degree of protection	124
8.1.7	Rated voltage	124
8.2	Technical specifications PN/MF Coupler (6ES7158-3MU10-0XA0)	125
A	Dimension drawing	129
B	Article numbers and accessories	130
C	Response times.....	131
D	Safety-related symbols.....	132
D.1	Safety-related symbols for devices without Ex protection	132
D.2	Safety-related symbols for devices with Ex protection.....	133
	Glossary	135
	Index.....	143

Documentation guide

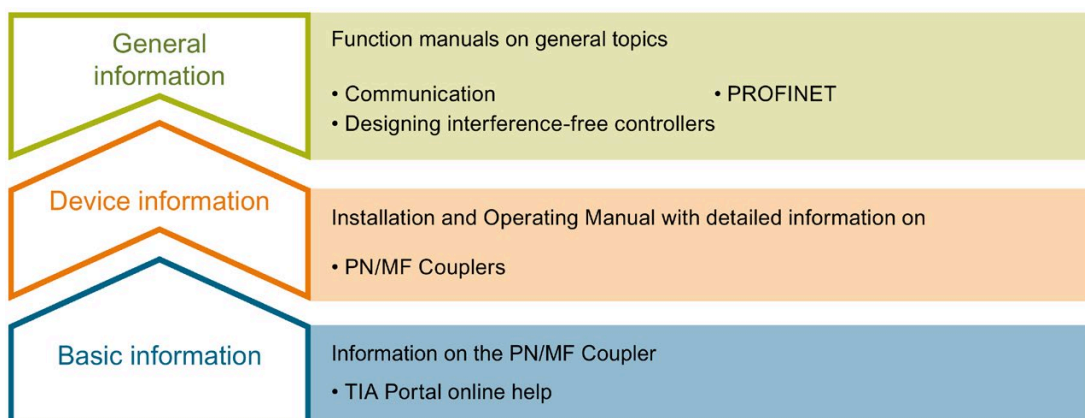

Device information

The PN/MF Coupler Installation and Operating Manual contains information, for example, on properties, assembling, connecting, configuring and parameter assignment, interrupts and diagnostics and technical specifications of the PN/MF Coupler.

General information

The function manuals contain detailed descriptions on general topics such as PROFINET and communication.

You can download the documentation free of charge from the Internet (<https://support.industry.siemens.com/cs/ww/en/view/109742709>).

"mySupport"

With "mySupport", your personal work area, you make the most of your Industry Online Support.

In "mySupport" you can store filters, favorites and tags, request CAx data and compile your own personal library in the Documentation area. Furthermore, your data is automatically filled in for support requests and you can get a quick overview of your current requests.

You need to register once to use the full functionality of "mySupport".

You can find "mySupport" on the Internet (<https://support.industry.siemens.com/My/ww/en>).

"mySupport" - Documentation

In the Documentation area of "mySupport", you have the possibility to combine complete manuals or parts of them to make your own manual.

You can export the manual in PDF format or in an editable format.

You can find "mySupport" - Documentation on the Internet (<https://support.industry.siemens.com/My/ww/en/documentation>).

"mySupport" - CAx Data

In the CAx Data area of "mySupport", you can access the latest product data for your CAx or CAe system.

You configure your own download package with a few clicks.

In doing so you can select:

- Product images, 2D dimension drawings, 3D models, internal circuit diagrams, EPLAN macro files
- Manuals, characteristics, operating instructions, certificates
- Product master data

You can find "mySupport" - CAx Data on the Internet (<https://support.industry.siemens.com/my/ww/en/CAxOnline>).

Application examples

The application examples support you with various tools and examples for solving your automation tasks. Here, solutions involving the interaction of multiple components in the system are shown, thus departing from the focus on individual products.

You can find the application examples on the Internet (<https://support.industry.siemens.com/sc/ww/en/sc/2054>).

SIMATIC Automation Tool

You can use the SIMATIC Automation Tool to perform commissioning and maintenance activities simultaneously on various SIMATIC S7 stations as a bulk operation independent of the TIA Portal.

The SIMATIC Automation Tool provides a multitude of functions:

- Scanning of a PROFINET/Ethernet system network and identification of all connected CPUs
- Address assignment (IP, subnet, gateway) and station name (PROFINET device) to a CPU
- Transfer of the date and the programming device/PC time converted to UTC time to the module
- Program download to CPU
- RUN/STOP mode switchover
- CPU localization by means of LED flashing
- Reading out of CPU error information
- Reading of the CPU diagnostic buffer
- Reset to factory settings
- Firmware update of the CPU and connected modules

You can find the SIMATIC Automation Tool on the Internet (<https://support.industry.siemens.com/cs/ww/en/view/98161300>).

PRONETA

With SIEMENS PRONETA (PROFINET network analysis), you analyze the plant network during commissioning. PRONETA features two core functions:

- The topology overview independently scans PROFINET and all connected components.
- PRONETA also scans: configuration of the station name, IP subnet mask and identification and maintenance data (I&M1..3)

You can find SIEMENS PRONETA on the Internet

(<https://support.industry.siemens.com/cs/ww/en/view/67460624>).

Product overview

2.1 Area of application and function

Area of application and customer benefits

You use the PN/MF Coupler in order to:

- connect an EtherNet/IP network to a PROFINET subnet
- interconnect two PROFINET subnets

To do this, use:

- User data via input or output address ranges which can be separated or coupled

The maximum size of the transferable input and output data is:

- 1440 bytes of input data and 1440 bytes of output data

The input and output data can be divided as desired. For example, you configure 1200 bytes of input data and 1340 bytes of output data.

The PN/MF Coupler is a device with two Ethernet interfaces:

- X1 for EtherNet/IP or PROFINET IO
- X2 for PROFINET IO

The two Ethernet networks are electrically isolated.

During configuring, STEP 7 creates two IO devices with their subnets from one PN/MF Coupler. The other part of the PN/MF Coupler in each case is known as the coupling partner.

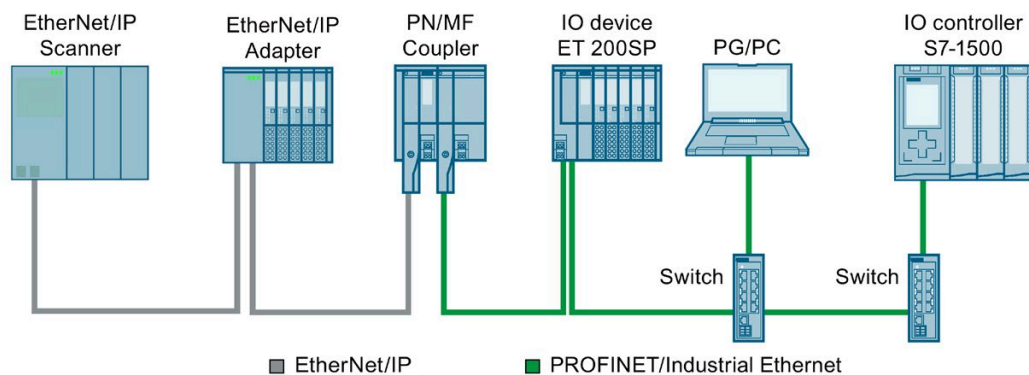

Figure 2-1 Coupling of an EtherNet/IP network and a PROFINET IO subnet with one PN/MF Coupler

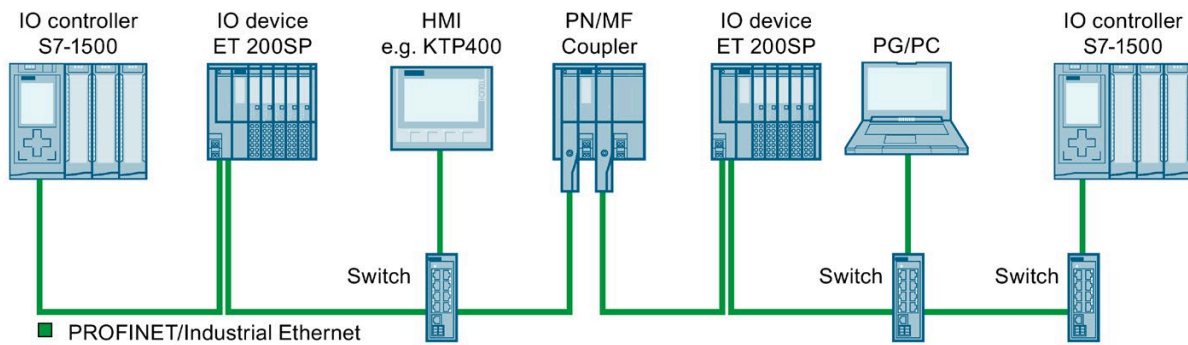

Figure 2-2 Coupling of two PROFINET IO subnets with one PN/MF Coupler

Principle of operation

- Data exchange with I/O modules:

Through the configured inputs of a slot, the local CPU or EtherNet/IP scanner reads the values that the CPU of the other subnet writes over the configured outputs of the coupling partner.

Through the configured outputs of a slot, the local CPU or EtherNet/IP scanner writes values that the CPU of the other subnet receives over the configured inputs of the coupling partner.

See also

Assignment of the modules (Page 40)

2.2 MultiFieldbus engineering

MultiFieldbus Configuration Tool (MFCT)

You create the configuration and parameterization of the MultiFieldbus Devices (IM 155-6 MF HF, PN/MF Coupler) with MFCT. You download the configuration and parameterization to the MF device with MFCT. The configuration and parameterization are retentively stored in the MF device. For structured access to the I/O data with EtherNet/IP, you can export a UDT file (file extension *.I5x).

Note

For commissioning with MFCT, the MF device must be connected via an Ethernet connection with **100 Mbps full duplex**.

Note

Only one instance of MFCT or PRONETA may be active in a network.

If PRONETA and MFCT are simultaneously active in the network, you must deactivate cyclic scanning in PRONETA.

Installation requirements for MFCT

You also need to install the following software for MFCT:

- Microsoft .NET Framework 4.6.1 (Offline Installer) (<https://www.microsoft.com/en-US/download/confirmation.aspx?id=49982>)
- WinPcap from directory "Misc"
- Microsoft C++ Redistributable:
 - For x86 systems (https://aka.ms/vs/15/release/vc_redist.x86.exe)
 - For x64 systems (https://aka.ms/vs/15/release/vc_redist.x64.exe)

Electronic Data Sheet (EDS)

For integration in EtherNet/IP configuration systems, a generic EDS file according to CIP specification Vol.1 is available for download (<https://support.industry.siemens.com/cs/ww/en/ps/27993>).

Requirements

You need at least MFCT version V1.1 to configure the PN/MF coupler.
You can find version information for MFCT on the "About" tab.

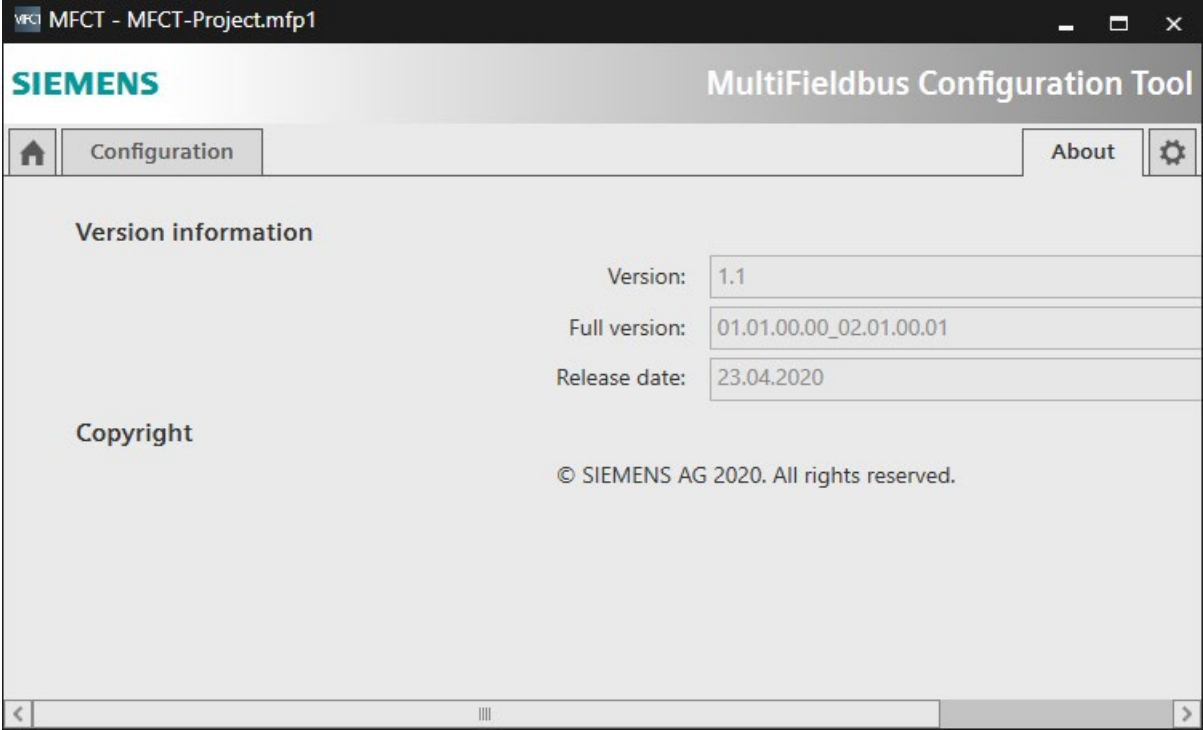

2.3 Properties

Article number

6ES7158-3MU10-0XA0

View

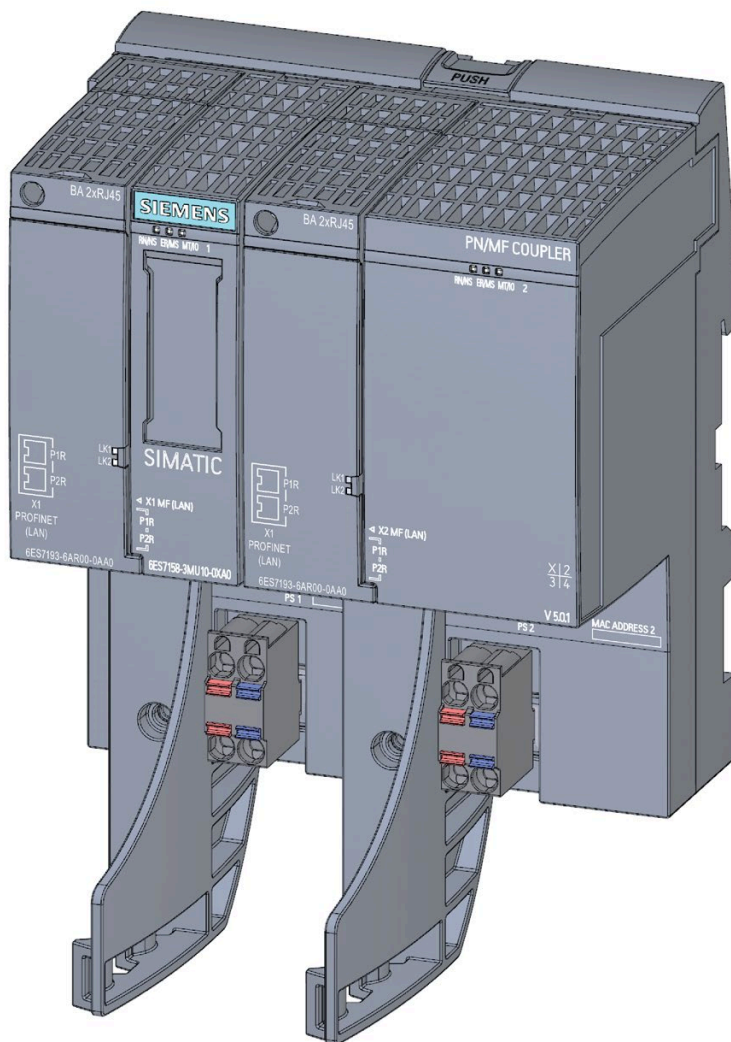

Figure 2-3 View of the PN/MF Coupler with mounted strain relief (accessory)

Properties

The PN/MF Coupler has the following properties:

- Data exchange between an EtherNet/IP scanner and a PROFINET IO controller across network boundaries while fully maintaining network separation, which means no support of routing functions.
- Data exchange between two PROFINET IO controllers across network boundaries while fully maintaining network separation, which means no support of routing functions.
- Compatible with the PN/PN Coupler V4.2 (except data set coupling, local coupling, MSI/MSO module, Shared Device, S2 redundancy, IRT and MRDP)
- Maximum of 16 input areas/output areas for exchange of data with the following virtual modules:
 - IN
 - OUT
 - PROFIsafe IN/OUT
- Electrical isolation between the two PROFINET IO subnets
- Electrical isolation between the EtherNet/IP network and the PROFINET IO subnet
- Redundant power supply
- Supply voltage 1L+/2L+ 24 V DC (SELV/PELV)
- Usable BusAdapters
 - BA 2×RJ45 for RJ45 bus connector
 - BA 2×FC for direct connection of the bus cable
 - BA 2×M12 for bus cable with M12 plug
- Diagnostics interrupts
- Extended channel diagnostics
- Status information of the input user data
- Reset to factory settings via RESET button
- Docking station
- Errors on one network side do not have an effect on the opposite network side but can be diagnosed.

Properties via PROFINET IO

- Data exchange in total of maximum 1440 bytes of input data and 1440 bytes of output data
- Integrated switch on both sides with 2 ports
- Supported Ethernet services: ping, arp, SNMP, LLDP
- Port diagnostics
- Port disabling
- Device replacement without removable medium/programming device
- Firmware update via PROFINET IO
- Prioritized startup
- Media redundancy MRP

Properties via EtherNet/IP

- I/O communication with scanner
- Configuring from the user program
- Read diagnostics (interrupts are not supported)
- Normative CIP objects
- Reset PN/MF Coupler to factory settings
- Diagnostics bit in data status of cyclic I/O data per submodule

Accessories

You order the following accessories separately:

- SIMATIC BusAdapter
- Strain relief
- Labeling strips
- Reference identification label

You can find a detailed list of available accessories in the appendix Article numbers and accessories (Page 130).

2.4 Operator controls and display elements

Display elements and interfaces

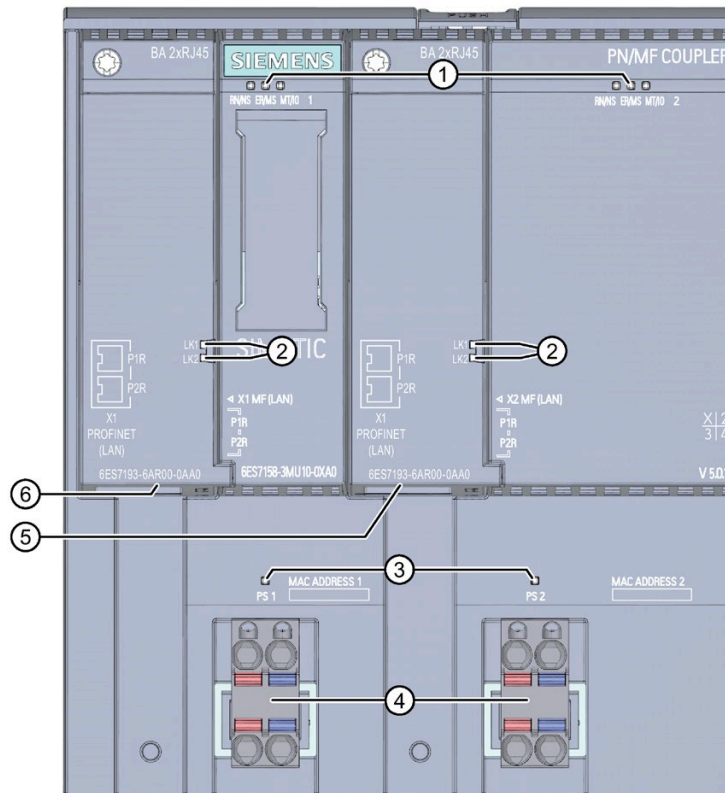

- ① Diagnostic LEDs for EtherNet/IP or PROFINET IO subnet 1 and 2 (X1, X2)
- ② Status LEDs for EtherNet/IP or PROFINET IO subnet 1 and 2 (X1, X2)
- ③ Status LEDs for connection of power supply PS1 / PS2
- ④ 24 V DC power supply PS1 / PS2 (X80/X81)
- ⑤ Ethernet interfaces for subnet 2 (X2)
- ⑥ Ethernet interfaces for subnet 1 (X1)

Figure 2-4 Display elements and interfaces of the PN/MF Coupler

X1 PROFINET and X2 PROFINET







For easier assignment of the BusAdapters, they are separated by left and right:

left BusAdapter	right BusAdapter
To the right of it: X300 BA slot	To the right of it: X301 BA slot
For the bus connections: P1R P2R	For the bus connections: P1R P2R

2.5 Detect active fieldbus

For exclusive operation on a fieldbus (not MF Shared Device) you can recognize the active fieldbus by the number of green LEDs on the MF device.

This requires that there are no errors and that the MF device is in cyclic data exchange with an IO controller/scanner.

LED schematic:	RN/NS	ER/MS	MT/IO
PROFINET	 Green	 Off	 Off
EtherNet/IP	 Green	 Green	 Green

Assembling

3.1 Assembly rules

Mounting position

You can install the PN/MF Coupler under the following conditions:

- for horizontal mounting $T_{\max} = 60\text{ °C}$
- for vertical mounting $T_{\max} = 50\text{ °C}$

You can find more information on the operating conditions in section General technical specifications (Page 110).

Open equipment

The PN/MF Coupler is open equipment. This means you may only install the PN/MF Coupler in enclosures, cabinets or electrical operating rooms and in a dry indoor environment (degree of protection IP20). The housings, cabinets and electrical operating rooms must guarantee protection against electric shock and spread of fire. The requirements regarding mechanical strength must also be observed. The housings, cabinets, and electrical operating rooms must not be accessible without a key or tool. Access may only be possible for instructed or authorized personnel.

Mounting technology

You install the PN/MF Coupler on a standard mounting rail (35 mm x 7.5 mm or 35 mm x 15 mm). For non-obstructed mounting, provide a clearance of 10 mm to the left of the module and 20 mm above the module.

3.2 Installing the PN/MF Coupler

Necessary components

- PN/MF Coupler
- SIMATIC BusAdapter
- Strain relief for mechanical load of the PROFINET connections
- Mounting rail:
 - Standard mounting rail (7.5 mm), or
 - Standard mounting rail (15 mm)

You can find the article numbers for the components in the appendix Article numbers and accessories (Page 130).

Installing the PN/MF Coupler on the standard mounting rail

1. Mount the standard mounting rail in such a way that sufficient space remains for installation of and heat dissipation of the module (at least 10 mm on the left and 20 mm above the module).
2. Hook the PN/MF Coupler into the standard mounting rail and swing it downward until you can hear it latch into place on the standard mounting rail.
3. Plug the BusAdapters onto the PN/MF Coupler and screw them in place.
4. Connect the PN/MF Coupler as described in section Connecting (Page 27).

Note

Low resistance connection

If the standard mounting rail is mounted on a grounded metal plate or a grounded device support plate, you must ensure a low-resistance connection between the standard mounting rail and base. For example, on painted or anodized metals, use suitable contacting agent or contact washers.

3.3 Removing the PN/MF Coupler

Removing the PN/MF Coupler

1. Switch off the power supply of the PN/MF Coupler. Disconnect the two 24 V DC connectors PS1 and PS2 from the PN/MF Coupler or the 24 V DC wiring.
2. Remove the SIMATIC BusAdapter.
3. Press the mounting rail release above the PN/MF Coupler.
4. While pressing the mounting rail release, swing the PN/MF Coupler off of the mounting rail.

3.4 Applying labeling strips

Procedure

Proceed as follows to apply a labeling strip:

1. Label the strip.
2. Insert the labeling strip into the PN/MF Coupler.

3.5 Applying reference identification labels

Procedure

Proceed as follows to apply a reference identification label:

1. Break off the reference identification labels from the sheet.
2. Insert the reference identification labels into the opening on the PN/MF Coupler. The insertion opening is located on the top in each case.

Note

Reference identification label

The printable side of the reference identification label must face forward.

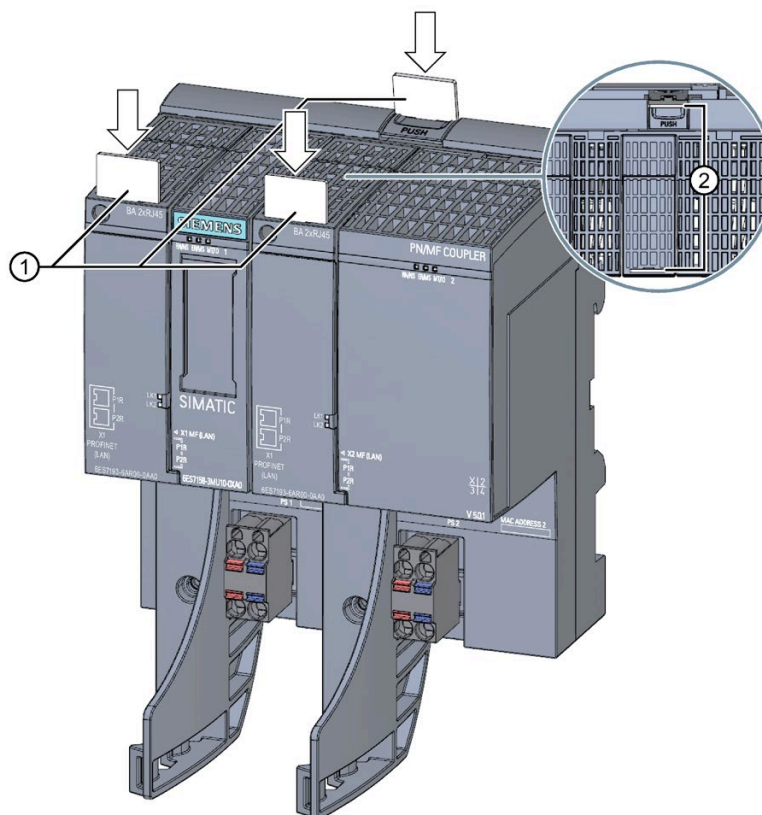

- ① Reference identification labels
- ② Insertion openings

Figure 3-1 Applying reference identification labels

3.6 Strain relief

Article number

6ES7193-6RA00-1AN0 (5 strain relief units incl. screws)

View

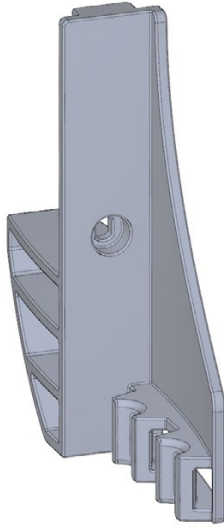

Figure 3-2 Strain relief

Properties

- The strain relief is a mechanical protective device for the electrical PROFINET cables on the BusAdapter.
- The strain relief is suitable for all optical and electrical PROFINET cables of the BusAdapter.
- The strain relief is an optional accessories.
- The cable ties are not included in the delivery. We recommend cable ties with a width of 4.8 mm. The maximum width is 7.0 mm. The length of the cable tie is min. 60 mm.
- The PROFINET cables are not inserted on the BusAdapter. The inserted PROFINET cables hamper the mounting of the strain relief.
- BusAdapter and strain relief can be mounted separately.

Required tools

Screwdriver TX10 (torx).

Procedure

To install the strain relief, follow these steps:

1. Press the strain relief below the BusAdapter seat of the PROFINET device.
2. Fasten the strain relief (1 screw with 0.7 to 0.8 Nm tightening torque).
3. Plug the BusAdapter into the PROFINET device.
4. Screw the BusAdapter to the PROFINET device (1 screw with 0.2 Nm tightening torque).
5. Fasten each PROFINET cable individually to the strain relief with the cable ties.

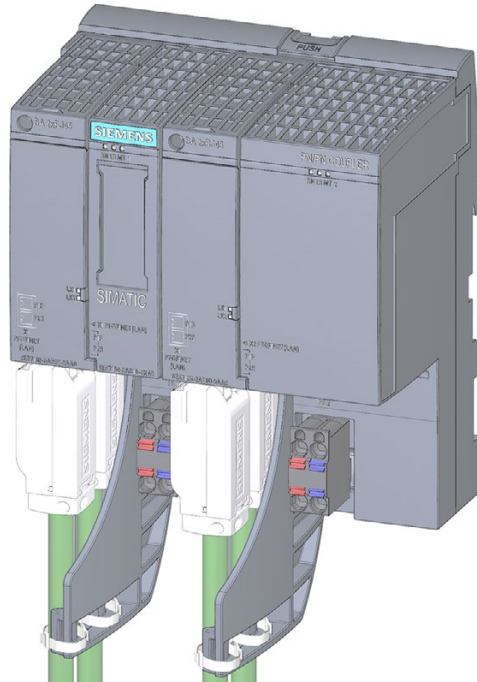

Figure 3-3 Strain relief installed

Connecting

4.1 Electrical isolation and grounding

4.1.1 Introduction

Redundant 24 V DC power supply

You have the option of connecting the PN/MF Coupler to two independent 24 V DC power supplies (SELV/PELV). Only one 24 V DC power supply is active at a time. If one power supply fails, the other becomes active automatically. You identify which power supplies (PS1, PS2 or both) are connected and will be diagnosed in the parameter assignment. The connection of one 24 V DC power supply is generally sufficient for operation of the PN/MF Coupler.

Properties of the PN/MF Coupler

- The two PROFINET IO subnets are galvanically isolated from each other.
- The two PROFINET IO subnets are galvanically isolated from the 24 V DC power supply.
- The two 24 V DC power supplies are galvanically isolated from each other.

Ungrounded infeed

It is always possible to configure an ungrounded setup of the PN/MF Coupler as the PN/MF Coupler has no fixed ground connection. The power pack/power supply module for 24 V DC must also be ungrounded and electrically isolated.

4.1.2 General operating rules and regulations

Introduction

For the PN/MF Coupler as a component of a system, special rules and regulations must be adhered to depending on the area of application.

The most important rules, which you must observe for safe integration into a plant or system, are listed below.

Specific application

Observe the safety and accident prevention regulations that are applicable to specific applications (e.g. machine protection guidelines).

EMERGENCY STOP equipment

EMERGENCY STOP devices according to IEC 60204 (corresponds to DIN VDE 113) must remain in effect in all operating modes of the plant or system.

System startup after certain events

The table below identifies situations you must pay attention to when the system starts up after the occurrence of certain events.

For
<ul style="list-style-type: none"> startup after a voltage dip or power failure startup after bus communication has been interrupted 	no dangerous operating states may occur. If necessary, "EMERGENCY STOP" must be forced!
<ul style="list-style-type: none"> startup after unlocking the emergency stop device startup without the IO controller activating the IO devices 	an uncontrolled or undefined startup must not occur

24 V DC power supply

The table below identifies what you must pay attention to for the 24 V supply.

For ...	you must ensure ...	
Buildings	External lightning protection	Provide lightning protection measures (e.g. Blitzductors)
24 V DC supply cables, signal cables	Internal lightning protection	
24 V supply	Safety extra-low voltage (SELV/PELV) with safe electrical isolation.	

Note

You can find additional information on lightning protection in function manual Installing S7-1500, ET 200MP, ET 200SP, ET 200AL controllers in an interference-proof manner (<https://support.industry.siemens.com/cs/ww/en/view/59193566>).

Protection from external electrical effects

The table below identifies what you must pay attention to for protection from electrical effects or faults.

For ...	you must ensure that ...
all systems in which the modules are integrated	... the system is connected to the protective conductor or the functional earth to discharge electromagnetic interference.
Connection, signal and bus cables	... the cable routing and installation are correct.

4.2 Connections

PN/MF Coupler connectors

The following figure shows all the connections that you establish to and from the PN/MF Coupler (in the figure, with BA 2×RJ45 BusAdapters):

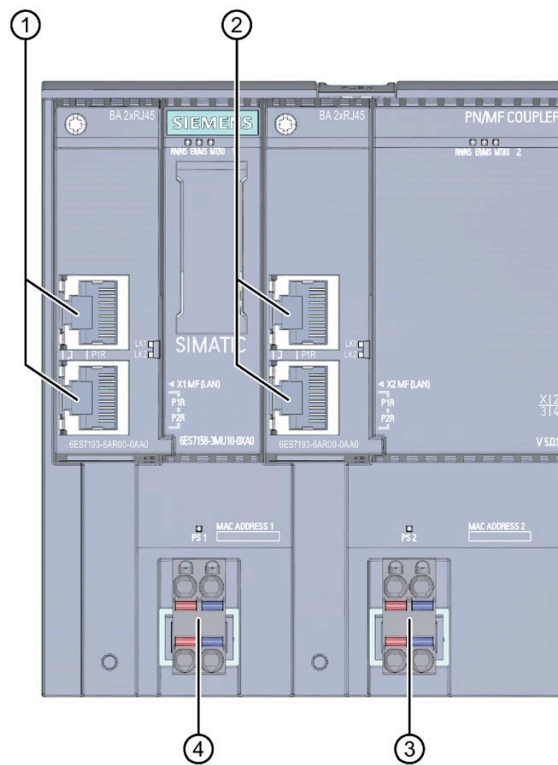

- ① EtherNet/IP or PROFINET IO subnet 1 (X1 PROFINET)
- ② PROFINET IO subnet 2 (X2 PROFINET)
- ③ Power supply 2 (24 V DC)
- ④ Power supply 1 (24 V DC)

Figure 4-1 PN/MF Coupler connectors

4.3 Connecting the power supply

Required tools

You need a screwdriver with a maximum blade width of 3.5 mm to connect the power supply.

Power supply unit

Only SELV/PELV power supplies with safe, electrically isolated, safety extra-low voltage ($\leq 60V$ DC) may be used.

Note the permissible operating voltage as specified in the technical specifications (Page 125).

Redundant power supply

You have the option of supplying the PN/MF Coupler from two voltage sources (redundant power supply):

- If one voltage source fails, the PN/MF Coupler automatically switches over to the other voltage source.
- If voltage is applied to both connections (PS1 / PS2), the PN/MF Coupler automatically uses the voltage source of PS1.
- If you only connect the PN/MF Coupler to one power supply, it is preferable to connect it to PS1.

Note

You can evaluate the diagnostics to determine whether the PN/MF Coupler is connected to both 24 V DC power supplies.

Connection for power supply

The power supply connections for the 24 V power supply are located on the front of the PN/MF Coupler. The connections have the following meaning:

Table 4-1 Connector assignment of power supply for the PN/MF Coupler

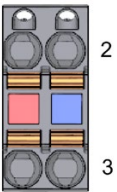
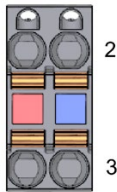
View		Signal name ¹				Description
Connector PS1 on X80	Connector PS2 on X81	Connector PS1		Connector PS2		
		1	1L+	1	1L+	+ 24 V DC of the supply voltage
		2	1M	2	1M	Ground of the supply voltage
		3	2M	3	2M	Ground of the supply voltage for loop-through ²⁾
		4	2L+	4	2L+	+ 24 V DC of the supply voltage for loop-through ²⁾

- ¹ X80/1L+ and X80/2L+ each have internal jumpers
 X80/1M and X80/2M each have internal jumpers
 X81/1L+ and X81/2L+ each have internal jumpers
 X81/1M and X81/2M each have internal jumpers

- ² Maximum 10 A permitted.

The maximum cross-section of the connection is 2.5 mm². A strain relief is not present. The connection plugs offer you the option of looping the power supply uninterrupted, even in unplugged state.

Procedure

To connect the power supply, follow these steps:

- Strip 8-10 mm of insulation from the wires.
- Press the spring release and insert the cable into the round opening of the connection plug as far as it will go. (The connection plugs are plugged into the power supply connection in the delivery state.)

If you have a redundant power supply of the PN/MF Coupler, connect the second power supply to the second connection plug.

If you are using only one voltage source, it is preferable to connect it to PS1.

Wiring rules for PN/MF Coupler

Wiring rules for ...		PN/MF Coupler (supply voltage)
Permitted cable cross-sections of solid cables (Cu)		0.2 to 2.5 mm ² AWG [*] : 24 to 13
Permitted cable cross-sections of flexible cables (Cu)	Without wire-end ferrule	0.2 to 2.5 mm ² AWG [*] : 24 to 13
	With wire-end ferrule (with plastic sleeve) ^{***}	0.25 mm to 1.5 mm ^{2**} AWG [*] : 24 to 16
	With TWIN wire-end ferrule ^{***}	0.5 mm to 1 mm ² AWG [*] : 20 to 17
Stripped length of the wires		8 to 10 mm
Wire-end ferrules in accordance with DIN 46228 with plastic sleeve ^{***}		8 and 10 mm long

* AWG: American Wire Gauge

** Wire-end ferrules without plastic sleeve: 0.25 to 2.5 mm²/AWG: 24 to 13

*** See note on wire-end ferrules

Note

Wire-end ferrules

Optimum results with respect to a high-quality and permanent electrical connection with maximum conductor pull forces at the same time can be achieved by using crimping dies, preferably with smooth surfaces, which are provided, for example, with rectangular and trapezoidal crimp cross-sections.

Due to the large number of crimping dies used in the industry, we can recommend others on request. Crimping dies with a pronounced wave profile are unsuitable.

Permissible cable temperature

Note

Permissible cable temperatures

At the maximum ambient temperature of the PN/MF Coupler, you must select sufficiently large wire cross-sections so that the permissible cable temperatures are not exceeded.

Examples:

- At an ambient temperature of 60° C, a current of, for example, 4 A per wire and a cross-section of 1.5 mm² Cu, a connecting conductor must be rated for a temperature range of at least 90° C.
- At an ambient temperature of 60° C, a current of, for example, 2 A per wire and a cross-section of 1.5 mm² Cu, a connecting conductor must be rated for a temperature range of at least 80° C.

4.4 Connecting the SIMATIC BusAdapter

SIMATIC BusAdapter

The SIMATIC BusAdapters connect the fieldbus to the PN/MF Coupler. You select the required connection technology and connection method for your process from the different versions of the SIMATIC BusAdapter.

You can find the SIMATIC BusAdapters that are available and how they are connected in the ET 200SP BusAdapter (<https://support.industry.siemens.com/cs/ww/en/view/109751716>) device manual.

4.5 Block diagram

Block diagram

The following figure shows the block diagram of the PN/MF Coupler.

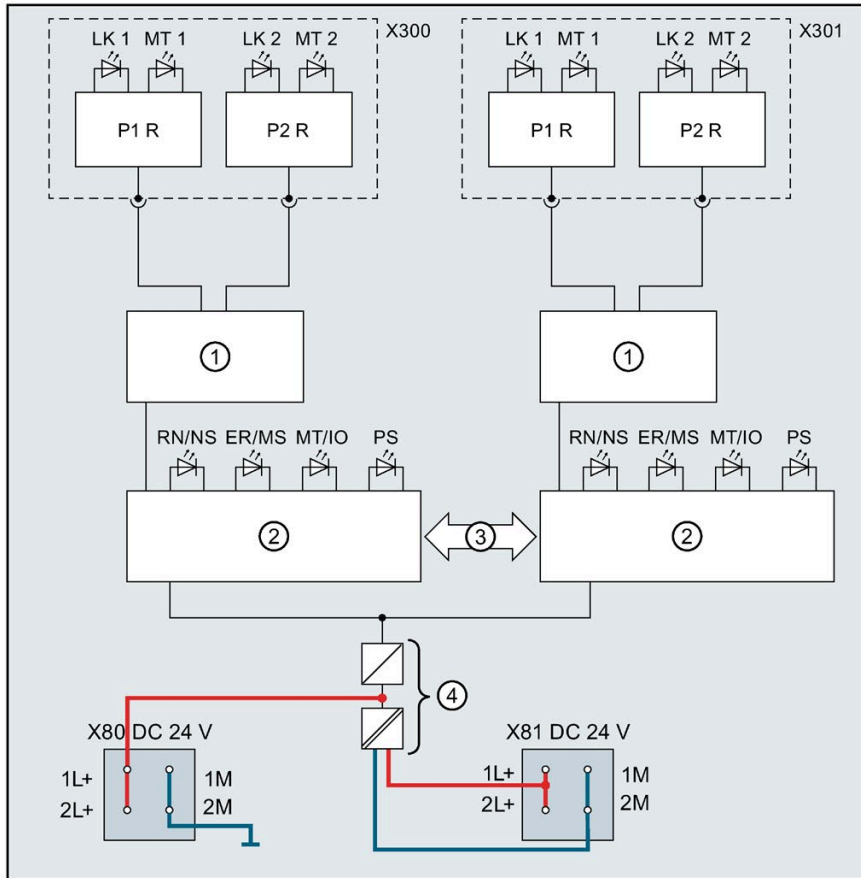

- ① Switch (component of the controller)
- ② Controller, right and left
- ③ Coupling
- ④ Internal power supply
- 24 V DC Supply voltage infeed
- X300 BusAdapter PROFINET interface X1
- X301 BusAdapter PROFINET interface X2
- P1 R PROFINET interface X1, X2 Port 1
- P2 R PROFINET interface X1, X2 Port 2

- L+ 24 V DC supply voltage
- M Ground
- LK 1, 2 Link LED
- MT 1, 2 FiberOptic LED (SCRJ port)
- RN/NS RUN LED (green)/Network status (red)
- ER/MS ERROR LED (red)/Module status (green)
- MT/IO MAINTENANCE LED (yellow)/I/O status (red/green)
- PS POWER LED (green)

Figure 4-2 PN/MF Coupler block diagram

PROFINET IO

5.1 PROFINET IO functions

5.1.1 Device replacement

Device replacement without topology configuration

The device name is also automatically permanently stored on the SIMATIC BusAdapter in addition to the PN/MF Coupler. A device name stored in the BusAdapter is required for device replacement without topology configuration.

Storing the name on the BusAdapter and the PN/MF Coupler produces a range of scenarios for using the device name when the PN/MF Coupler is replaced.

Table 5-1 Scenarios for using the device name

	PN/MF Coupler without a device name	PN/MF Coupler with a device name
BusAdapter without a device name	No device name available	The device name from the PN/MF Coupler is used and copied to the BusAdapter.
BusAdapter with device name	The device name from the BusAdapter is used and copied to the PN/MF Coupler.	The device name from the BusAdapter is used and copied to the PN/MF Coupler if the device names are different.

Note the following constraints:

- Resetting to factory settings deletes the device name in both the PN/MF Coupler and the BusAdapter. To prevent the device name from being deleted in the BusAdapter, you can remove the BusAdapter from the PN/MF Coupler before resetting to factory settings.
- When a BusAdapter is replaced, a device name stored in the BusAdapter is applied in the PN/MF Coupler after a POWER ON.
- Removal/insertion of the BusAdapter under voltage is not permitted. If you nevertheless remove or insert the BusAdapter under voltage, the PN/MF Coupler restarts.

Device replacement with topology configuration

IO devices with this function can be replaced in a simple manner. The device name does not have to be assigned with the PG/PC.

The replacement IO device is assigned the device name by the IO controller and not by the PG/PC. The IO controller uses the configured topology and the neighborhood relationships determined by the IO devices for this purpose. All involved devices must support the LLDP protocol (Link Layer Discovery Protocol). The configured topology must match the actual topology.

IO devices that were already used in another configuration must be reset to factory settings before being reused.

You can find more information:

- In the STEP 7 online help
- as of STEP 7 V14, in the SIMATIC PROFINET Function Manual (<https://support.industry.siemens.com/cs/ww/en/view/49948856>).

5.1.2 Media redundancy (MRP)

Media redundancy (MRP)

Function for safeguarding communication and system availability. A ring topology ensures that an alternative communication path is made available if a transmission route fails.

You can find more information:

- In the STEP 7 online help
- as of STEP 7 V14, in the SIMATIC PROFINET Function Manual (<https://support.industry.siemens.com/cs/ww/en/view/49948856>).

Note

Prioritized startup and media redundancy

It is not possible to include an IO device with prioritized startup in a ring topology with media redundancy.

5.1.3 Docking station

PN/MF Coupler as docking station and docking unit

The PN/MF Coupler is available as a docking station and also as a docking unit.

The following figure shows an automation cell with a PN/MF Coupler as a docking station and several docking units.

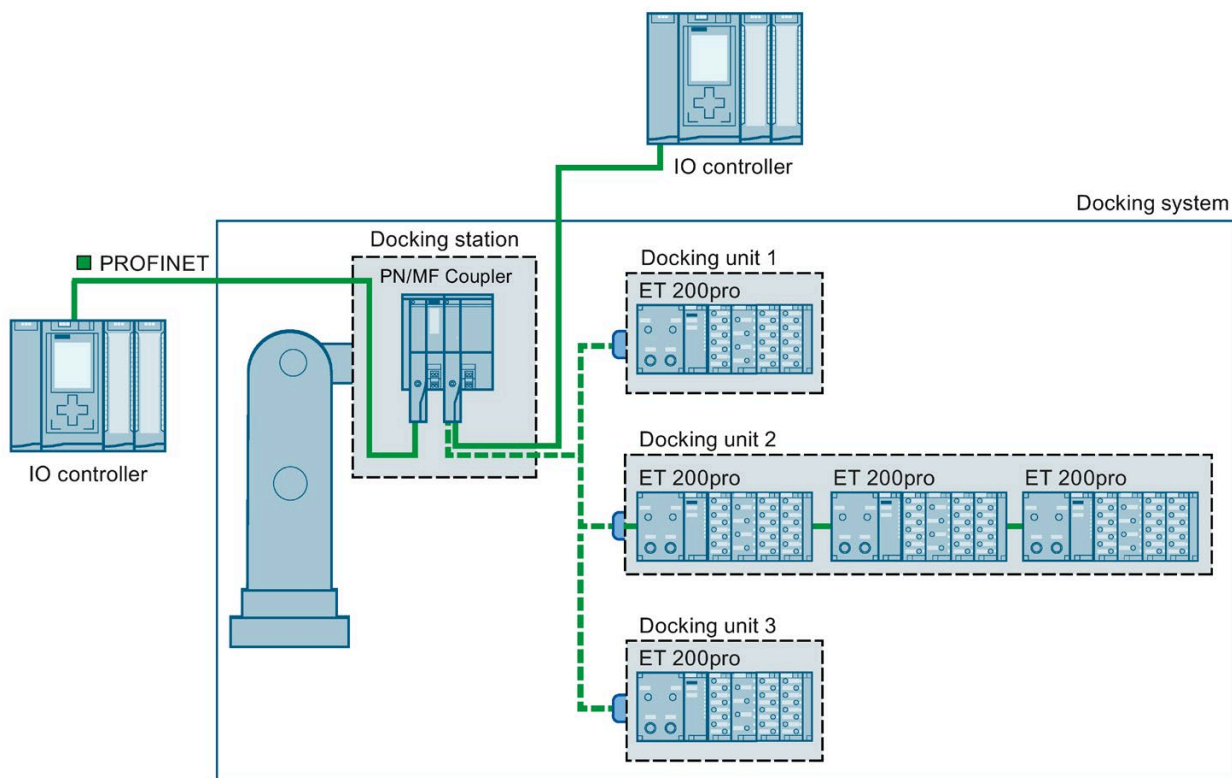

Figure 5-1 PN/MF Coupler as docking station

The following figure shows an automation cell with a PN/MF Coupler as docking unit.

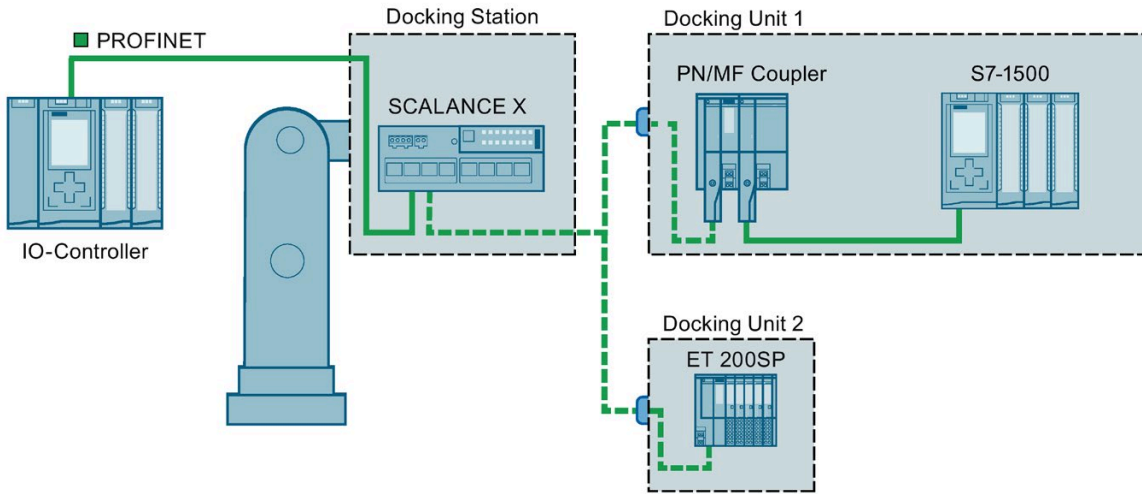

Figure 5-2 PN/MF Coupler as docking unit

Requirements

You need to be aware of the following points:

- The IO devices of all docking units must be deactivated as default in the configuration.
- Only one docking unit can be active at any one time.

Reaction time with PROFINET IO

You use the PN/MF Coupler as a docking unit. In this function, you must note the different startup times of the respective interfaces of the PN/MF Coupler:

Startup times of up to

- Side X1: 650 ms
- Side X2: 750 ms can be reached.

Area of application

You can use the PROFINET "Tool Changer" functionality, for example, for tool changing in robots. Typical tools include:

- Welding guns
- Positioning tools for manufacturing parts

See also

See also in STEP 7 online help.

5.2 Configuring, parameter assignment and commissioning with PROFINET IO

5.2.1 Configuring and commissioning the PN/MF Coupler (Overview)

Overview

The following table shows the steps you must perform up to and including commissioning.

Table 5- 2 Procedure for configuring and commissioning the PN/MF Coupler

Step	Action	Content	Additional information in section
1	Mounting	Mount the PN/MF Coupler on the mounting rail.	Assembling (Page 21)
2	Connecting	Connect the PN/MF Coupler to the power supply and PROFINET IO.	Connecting (Page 27)
3	Configuring the PN/MF Coupler	Configuring X1 with MFCT for EtherNet/IP	Configuring with MFCT (Page 60)
		Configuring X2 with GSD file for PROFINET	Configuring the PN/MF Coupler with GSD file (Page 41)
		Configuring X1 and X2 in case of compatibility* with STEP 7 TIA Portal	Configuring the PN/MF Coupler with STEP 7 TIA Portal (Page 42)
4	Parameter assignment	Assign the PN/MF Coupler parameters with a different configuration tool.	Parameters (Page 45) and STEP 7 online help
5	Commissioning the PN/MF Coupler	Switch on the PN/MF Coupler and download the configuration.	Commissioning the PN/MF Coupler (Page 47)

* Please note the supported functions in case of compatibility.

5.2.2 Requirements

To configure the PN/MF Coupler under PROFINET IO, you need the following component:

- STEP 7 TIA Portal V15.1 or higher
- GSD file of the PN/MF Coupler. The GSD files can be downloaded on the Internet (<https://support.industry.siemens.com/cs/ww/en/view/23742537>).

5.2.3 Assignment of the modules

Introduction

You configure the PN/MF Coupler by configuring both sides separately.

You configure the network side X1 for EtherNet/IP with MFCT (Page 60) and network side X2 for PROFINET with GSD file in STEP 7 (Page 41).

The assignment of the modules is shown in the following table only from network side 1 (X1) to network side 2 (X2). It is also possible to swap the network sides.

Table 5- 3 Assignment of the modules in the "IO Modules" module operating mode

Modules network side 1 (X1)	Assigned IO modules network side 2 (X2)
Output module (OUT)	Input module (IN)
Input module (IN)	Output module (OUT)
PROFIsafe IN/OUT ¹	PROFIsafe IN/OUT ¹

¹ Only for PROFIsafe communication

The data length of the respective IO module must be the same for both sides. If you configure an "IN 16 Byte+DS" on network side X1, for example, you must configure "OUT 16 Byte" for network side X2.

PROFIsafe module

You have to observe the following for "PROFIsafe IN/OUT":

- You may only use safety-related communication for "PROFIsafe IN/OUT".
- The data status byte becomes obsolete. The validity of the coupled user data is guaranteed by the mechanisms of the safety-related communication.
- The safety-related communication with "PROFIsafe IN/OUT" is only possible between S7-1200/1500 F-CPU's.

We recommend that you do not use the respective modules for other applications due to the missing data status byte (DS).

5.2.4 Configuring the PN/MF Coupler with GSD file

Introduction

You configure the PN/MF Coupler using a GSD file. You integrate the PN/MF Coupler as an IO device in your configuration tool using this file. The GSD files can be downloaded on the Internet (<https://support.automation.siemens.com/WW/view/en/23742537>).

GSD file

The following GSD file is available for the PN/MF Coupler:

GSDML-V2.35-Siemens-PNPNIOC-"date in format yyyyymmdd".xml

You can find more information on the procedure with GSD files in the STEP 7 online help.

Configuring the PN/MF Coupler

You configure the PN/MF Coupler with your configuration tool like any other IO device on PROFINET IO.

Download the complete GSD file for the PN/MF Coupler to your configuration tool. You configure the PN/MF Coupler separately in each of the two subnets. Select the IO device labeled with X1 or X2 in each case.

Note the following when assigning the device name for the PN/MF Coupler: This device name must be unique in the Ethernet subnet. The device name must comply with the DNS conventions.

When configuring using a GSD file, various modules are available for the data record transfer, each of which has a fixed length. Support for configuring the coupling of the two subnets (as is available in STEP 7) is not possible when configuring using a GSD file. Note the permitted assignment of modules (see Assignment of the modules (Page 40)).

Example

Assuming that you want to read 64 bytes and write 128 bytes on network side X2 from network side X1, you need to configure the following for network side X2 in STEP 7 (TIA Portal) with GSD file:

Module	...	Rack	Slot	I address	Q address	Type
▼ PN-PN-Coupler		0	0			PN/MF Coupler X2
▶ PN-IO-02		0	0 X2			PN-PN-Coupler
IN 64 Byte+DS_1		0	1	27...91		IN 64 Byte+DS
OUT 128 Byte_1		0	2		2...129	OUT 128 Byte

Information on how to configure network side X1 with MFCT is available at "Configuring a station (Page 67)".

5.2.5 Configuring the PN/MF Coupler with STEP 7 TIA Portal

5.2.5.1 Configuring the PN/MF Coupler with STEP 7 TIA Portal

Configuration of the PN/MF Couplers

1. Drag PN/MF Coupler 6ES7158-3AD10-0XA0 from the Network components/Gateways directory of the hardware catalog to the PROFINET network.
2. Double-click the symbol of the PN/MF Coupler.
3. Assign a device name for the PN/MF Coupler and confirm with "OK".
The device name must be unique on the Ethernet subnet. The device name must comply with the DNS conventions. You can find more information about assigning the device name in the STEP 7 online help.
4. For configuring the left side of the bus (X1), click the symbol of the PN/MF Coupler.
5. Open the "Module parameters/Transfer mapping" table in PNP Coupler.x1. Create up to 16 slots of the PN/MF Coupler in the table. Note the permitted assignment of modules (see Assignment of the modules (Page 40)).

Note**Assigning the device name**

Assign the device names to the PN/MF Coupler online.

Result

Configuring is complete for both sides of the PN/MF Coupler.

Coupling both subnets

The two sides are constantly kept consistent in the TIA Portal. Changes to side X1 lead automatically to the adaptation of side X2, and vice versa. This requires that the two bus sides X1 and X2 are in the same project or in a multi-project.

Recommended procedure when you make changes on the couple partner:

1. Perform the changes (e.g. add I/O modules).
2. Execute the "Save and compile" function for both bus sides.

Result: The configuration is consistent.

5.2.5.2 Example: Configuring with STEP 7 TIA Portal

Task

You want to transfer I/O data to or from the IO controller:

Bus side X1	Bus side X2
2 bytes inputs (IN 2 bytes)	2 bytes outputs (OUT 2 bytes)
8 bytes outputs (OUT 8 bytes)	8 bytes inputs (IN 8 bytes)
8 bytes inputs (IN 8 bytes)	8 bytes outputs (OUT 8 bytes)
2 bytes outputs (OUT 2 bytes)	2 bytes inputs (IN 2 bytes)
6 byte inputs / 12 byte outputs (IN/OUT 6 bytes / 12 bytes)	12 byte inputs / 6 byte outputs (IN/OUT 12 bytes / 6 bytes)

Configuring the PN/MF Coupler in subnet 1 in STEP 7 TIA Portal

The configuration of the PN/MF Coupler in subnet 1 (bus side X1) is as follows:

Transfer area	Virtual slot	Type	I-length		Q-length		I-address	Q-address
Transfer area_1	1	IN	2	Byte(s)			10...11	
Transfer area_2	2	OUT			8	Byte(s)		8...15
Transfer area_3	3	IN	8	Byte(s)			12...19	
Transfer area_4	4	OUT			8	Byte(s)		16...23
Transfer area_5	5	IN/OUT	6	Byte(s)	12	Byte(s)	20...25	24...35

Configuring the PN/MF Coupler in subnet 2 in STEP 7 TIA Portal

The configuration of the PN/MF Coupler is exactly the opposite of the configuration in subnet 1. This configuration takes place at the same time in the "Mapping of IO data from PROFINET interface X1 to X2". The configuration of the PN/MF Coupler in subnet 2 (bus side X2) is as follows:

Transfer area	Virtual slot	Type	I-length		Q-length		I-address	Q-address
Transfer area_1	1	OUT			2	Byte(s)		10...11
Transfer area_2	2	IN	8	Byte(s)			8...15	
Transfer area_3	3	OUT			8	Byte(s)		12...19
Transfer area_4	4	IN	8	Byte(s)			16...23	
Transfer area_5	5	IN/OUT	12	Byte(s)	6	Byte(s)	24...35	20...25

Result

You have configured your I/O data in the PN/MF Coupler.

5.2.5.3 Generating a GSD file with STEP 7 TIA Portal

Generating a GSD file for only one side

You have finished configuring your PN/MF Coupler and want to generate a GSD file for side X1 or X2.

1. Click the "Export" button in the "Export generic station description file (GSD)" field in the transfer mapping.
2. The "Export generic station description (GSD)" for X1 or X2 is offered. Enter the path and the file name.
3. Select "Export".

Result: The GSD file has been created for one PROFINET side.

Example: GSD file for X2

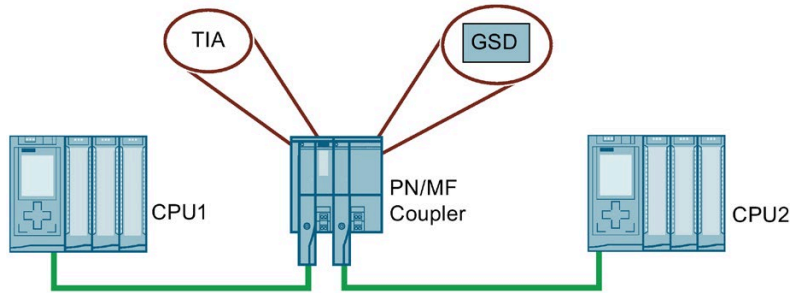

Figure 5-3 PN/MF Coupler and GSD file

Configuration

You have configured both CPU with inputs and outputs. This is how it looks in the "Module parameters/transfer mapping" table:

Table 5- 4 Configuration in subnet 1 (bus side X1)

	Transfer area	Virtual slot	Type	I-length		Q-length		I-address	Q-address	Access
1	Transfer_area_1	1	IN	2	Byte(s)			13..14		CPU1
2	Transfer_area_2	2	OUT			8	Byte(s)		20...27	CPU1
3	Transfer_area_3	3	IN	8	Byte(s)			15...23		CPU1
4	Transfer_area_4	4	OUT			8	Byte(s)		28...35	CPU1

Table 5- 5 Configuration in subnet 2 (bus side X2)

Transfer area	Virtual slot	Type	I-length		Q-length		I-address	Q-address	Access
Transfer_area_1	1	OUT			2	Byte(s)		10...11	CPU2
Transfer_area_2	2	IN	8	Byte(s)			8...15		CPU2
Transfer_area_3	3	OUT			8	Byte(s)		12...19	CPU2
Transfer_area_4	4	IN	8	Byte(s)			16...23		CPU2

GSD from bus side X2

Click the "Export" button in the "Export generic station description file (GSD)" field in the transfer mapping. The "Export device description (GSD)" function is offered for X2. Enter the path and the file name. Then select "Export".

The GSD file is created for the PROFINET page X2. And you can use them, for example, for other machine manufacturers.

5.2.6 Parameters

Table 5- 6 Parameters for the PN/MF Coupler

Parameter	Range of values	Default setting
Voltage check PS1	deactivated/activated	deactivated
Voltage check PS2	deactivated/activated	deactivated
Diagnostics Undervoltage	deactivated/activated	deactivated
Data validity display DIA	deactivated/activated	deactivated
Diagnostics for data validity	deactivated/activated	activated
Diagnostics for error in other network	deactivated/activated	activated
Diagnostics for difference in network configuration	deactivated/activated	activated

You can assign the parameters separately for the two sides of the PN/MF Coupler.

STEP 7 generates interrupts (e.g. when monitoring a power supply) separately for each side.

Voltage check PS1 / PS2

If you have enabled the voltage check PS1 / PS2, the PN/MF Coupler diagnoses the failure of the power supply on the two bus sides independent of one another. Only activate the voltage check if the corresponding power supply is actually connected.

Diagnostics Undervoltage

An undervoltage diagnostics is triggered when the supply voltage drops below 19.2 V.

Once the supply voltage exceeds 20.4 V again, an undervoltage diagnostics is no longer shown.

If the voltage falls below the lower voltage limit at only one of the two feeds, the diagnostics is not yet triggered, because measurements are taken at the common internal voltage supply (see Block diagram (Page 34)).

The undervoltage diagnostics is displayed as maintenance interrupt according to the above description after release via the module parameters (Interrupts (Page 55)).

Data validity display DIA

You use the data validity display DIA to determine whether or not the IO controller connected via the PN/MF Coupler still supplies valid data from the "other" subnet.

Only activate the data validity display DIA if you have configured inputs on the relevant side of the PN/MF Coupler. Modules for the data record transfer are not taken into consideration for this.

The validity of the data is always displayed in bit 0 of the least significant input byte of the PN/MF Coupler. The least significant input byte is the lowest slot number of the first input module.

Bit 0 = 1: received data are valid.

Bit 0 = 0: received data are invalid.

Possible causes:

- An interface of the PN/MF Coupler is faulty
- The PN/MF Coupler in the other subnet has failed
- The IO controller in the other subnet is in STOP state

CAUTION

Incorrect program interpretation

If you have activated the "Data validity display DIA", you must not use the first bit of the first configured input byte for input data or the associated first bit of the first configured output byte in the other subnet for output data!

Diagnostics for data validity

You use the diagnostics for data validity to determine if the IO controller of the other subnet is in STOP state. The online diagnostics indicates "Data invalid" for the respective slot.

This diagnostic message is selected by default and can be disabled for each interface separately.

Diagnostics for error in other network

You use the diagnostics for error in other network to determine that the other bus side has no configuration data.

This diagnostic message is selected by default and can be disabled for each interface separately.

Diagnostics for difference in network configuration

With the diagnostics for difference in network configuration, the PN/MF Coupler outputs a diagnostics interrupt indicating an invalid mapping for the two bus sites.

This diagnostic message is selected by default and can be disabled for each interface separately.

Reference

You can find additional information in section "Diagnostics for Shared Device".

5.2.7 Commissioning the PN/MF Coupler

Requirements

The following requirements must be met before commissioning the PN/MF Coupler:

- You have completely configured and connected the PN/MF Coupler as described in sections Assembling (Page 21) and Connecting (Page 27).
- You have completely set up both PROFINET IO subnets. PROFINET IO is ready for operation.
- You have configured the PN/MF Coupler.
- You have assigned the PN/MF Coupler parameters.

Commissioning the PN/MF Coupler

1. Switch on the power supply for the PN/MF Coupler.
2. Assign a device name to the PN/MF Coupler for each subnet.
3. Download the configuration to the target system.

5.2.8 Identification data

Definition

Identification data is data that is stored in a module that supports you in:

- Checking the system configuration
- Locating hardware changes in a system
- Troubleshooting in a system

You can unambiguously identify and localize modules online with the identification data.

In STEP 7 TIA Portal, the identification data is displayed on the "Module status - PN/MF Coupler" and "Properties - PN/MF Coupler" tabs (see STEP 7 online help).

Reading the identification data

Each of the two bus sides of the PN/MF Coupler has its own memory area for identification data. You can enter and read out the identification data separately for each of the two bus sides (except I&M0).

You selectively access certain identification data using **Read data record**. Under the associated data record index you obtain the corresponding part of the identification data.

The data records are structured according to the following principle:

Table 5- 7 Basic structure of data records with identification data

Content	Length (bytes)	Coding (hex)
Header information		
BlockType	2	I&M0: 0020 I&M1: 0021 I&M2: 0022 I&M3: 0023
BlockLength	2	I&M0: 0038 I&M1: 0038 I&M2: 0012 I&M3: 0038
BlockVersionHigh	1	01
BlockVersionLow	1	00
Identification data		
Identification data (see table below)	I&M0: 54 I&M1: 54 I&M2: 16 I&M3: 54	

5.2 Configuring, parameter assignment and commissioning with PROFINET IO

The data structures in the data records correspond to the specifications of PROFINET IO.

Table 5- 8 Identification data

Identification data	Access	Default setting	Explanation
Identification data 0: (data record index AFF0 hex)			
VendorIDHigh	Read (1 byte)	00 hex	Name of the manufacturer: 42 dec = SIEMENS AG
VendorIDLow	Read (1 byte)	2A hex	
Order_ID	Read (20 bytes)	6ES7158-3AD10-0XA0	Article number of the module
IM_SERIAL_NUMBER	Read (16 bytes)		Serial number (device-specific)
IM_HARDWARE_REVISION	Read (2 bytes)	1	Corresponding Hardware version
IM_SOFTWARE_REVISION	Read	Firmware version	Firmware version of the module
• SWRevisionPrefix	(1 byte)	V, R, P, U, T	
• IM_SWRevision_Functional_Enhancement	(1 byte)	05 - FF hex	
• IM_SWRevision_Bug_Fix	(1 byte)	00 - FF hex	
• IM_SWRevision_Internal_Change	(1 byte)	01 - FF hex	
IM_REVISION_COUNTER	Read (2 bytes)	-	Configured changes on the module
IM_PROFILE_ID	Read (2 bytes)	0000	Generic Device
IM_PROFILE_SPECIFIC_TYPE	Read (2 bytes)	0005 hex	On interface modules
IM_VERSION	Read	0101 hex	Version of the identification data (0101 hex = Version 1.1)
• IM_Version_Major	(1 byte)		
• IM_Version_Minor	(1 byte)		
IM_SUPPORTED	Read (2 bytes)	000E hex	Available identification data (I&M1 to I&M3)
Maintenance data 1: (data record index AFF1 hex)			
IM_TAG_FUNCTION	Read/write (32 bytes)	-	Enter an identifier for the module here, that is unique system-wide.
IM_TAG_LOCATION	Read/write (22 bytes)	-	Enter the installation location of the module here.
Maintenance data 2: (data record index AFF2 hex)			
IM_DATE	Read/write (16 bytes)	YYYY-MM-DD HH:MM	Enter the installation date of the module here.
Maintenance data 3: (data record index AFF3 hex)			
IM_DESCRIPTOR	Read/write (54 bytes)	-	Enter a comment about the module here.

5.3 PROFINET IO interrupts, diagnostics, error messages and system events

5.3.1 Diagnostics via LED displays

LEDs on the PN/MF Coupler

The LEDs on the PN/MF Coupler and their function are described below.

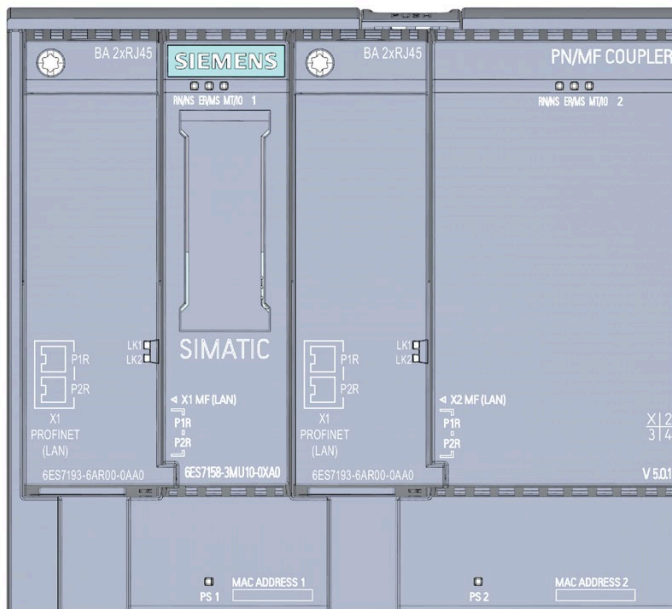

- RN 1 RUN LED network side 1 (green)
- RN 2 RUN LED network side 2 (green)
- NS 1 NET STATUS LED network side 1 (green/red)
- NS 2 NET STATUS LED network side 2 (green/red)
- ER 1 ERROR LED network side 1 (red)
- ER 2 ERROR LED network side 2 (red)
- MS 1 MODULE STATUS LED network side 1 (green/red)
- MS 2 MODULE STATUS LED network side 2 (green/red)
- MT 1 Maintenance indicator network side 1 (yellow)
- MT 2 Maintenance indicator network side 2 (yellow)
- IO 1 IO STATUS LED network side 1 (green/red)
- IO 2 IO STATUS LED network side 2 (green/red)
- LK 1 Connection to a switch or IO controller (green) at Port1
- LK 2 Connection to a switch or IO controller (green) at Port2
- PS 1 Power supply network side 1 (green)
- PS 2 Power supply network side 2 (green)









Figure 5-4 LEDs on the PN/MF Coupler





Meaning of the LED displays

The following tables contain the meanings of the status and error displays.

RN/NS, ER/MS, MT/IO LEDs on the PN/MF Coupler

Table 5-9 Status and error displays of the RN/NS, ER/MS, MT/IO LEDs

LEDs			Meaning	Remedy
RN/NS 1/2 (RUN)	ER/MS 1/2 (ERROR)	MT/IO 1/ 2(MAINT)		
 Off	 Off	 Off	Missing or insufficient supply voltage on the PN/MF Coupler.	Check the supply voltage.
 On	 On	 On	RN/ER/MT LEDs are continuously On and RN/ER/MT LEDs of the other interface are Off or flashing: Hardware or firmware defective. Error information will be determined and stored retentively on the Flash memory.	Do not disconnect the PN/MF Coupler from the supply voltage as long as X1 LEDs are continuously lit (this process may take a few minutes).
			RN/ER/MT LEDs are continuously On and RN/ER LEDs of the other interface are flashing: Startup was stopped because a BusAdapter that is defective or not supported was detected on the other interface.	Replace the BusAdapter of the other interface.
 Flashes	Not relevant	Not relevant	PN/MF Coupler is deactivated.	Activate the PN/MF Coupler with the configuration software or the user program.
			PN/MF Coupler is not configured.	Configure the PN/MF Coupler with the configuration software.
			PN/MF Coupler is starting up.	---
			PN/MF Coupler is being assigned parameters.	---
 On	Not relevant	Not relevant	PN/MF Coupler is currently exchanging data with the IO controller.	---
			Not relevant	Flashes
The preset configuration does not match the actual configuration of the PN/MF Coupler .	Check the configuration of the PN/MF Coupler, to determine whether it is correct.			
Parameter assignment error	Evaluate the display of the module status in STEP 7. Eliminate the error in the corresponding I/O module.			
Not relevant	Not relevant	 On	Maintenance demanded	See section Interrupts (Page 55)

LEDs			Meaning	Remedy
RN/NS 1/2 (RUN)	ER/MS 1/2 (ERROR)	MT/IO 1/2(MAINT)		
 Flashes	 Flashes	 Flashes	The "Node flash test" is running (the LK1 and LK2 LEDs of the PROFINET interface also flash). Hardware or firmware defective (The LK1 and LK2 LEDs of the PROFINET interface do not flash).	--- Restart the device by disconnecting and reconnecting the supply voltage. Run a firmware update. If the error persists, contact Siemens Industry Online Support (see also Reading service data (Page 57)). Replace the PN/MF Coupler.
 Flashes	 Flashes	Not relevant	Startup was stopped because a BusAdapter that is defective or not supported was detected.	Replace the BusAdapter of this interface.

PS LEDs on the PN/MF Coupler

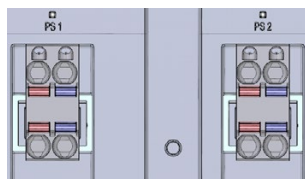







Figure 5-5 PS LEDs on the PN/MF Coupler

Table 5- 10 Status display of the PS LED

PS 1/2 LED	Meaning	Remedy
 Off	Missing or insufficient supply voltage	Check the supply voltage.
 On	Supply voltage present	---

LK1/LK2 LEDs on the BusAdapter

Table 5- 11 Status and error displays of LK1/LK2 LEDs

LED	Meaning	Remedy
LK1/LK2		
 Off	There is no Ethernet connection between the PROFINET IO interface of your PROFINET device and a communication partner (e.g. IO controller).	Check whether the bus cable to the switch/IO controller is interrupted.
 On	There is an Ethernet connection between the PROFINET IO interface of your PROFINET device and a communication partner (e.g. IO controller).	---
 Flashes	The "Node flash test" is running. (The RN/ER/MT LEDs are also flashing.)	---

5.3.2 Diagnostics by user program

5.3.2.1 Extended channel diagnostics

Function

The channel diagnostics provides information about channel faults of the PN/MF Coupler. Channel faults are mapped as channel diagnostics in IO diagnostic data records. You read the data record with the "RDREC" instruction.

Structure of the diagnostic data records

The data records supported by the PN/MF Coupler are based on the PROFINET IO standard - Application Layer Service Definition V2.3.

If necessary, you can purchase the standard from the PROFIBUS Nutzerorganisation (PROFIBUS user organization (<https://www.profibus.com>)).

Codes of the extended channel diagnostics

The following extended channel diagnostics are signaled for the PN/MF Coupler:

Slot number	ChannelError-Type (CET)	ExtendedChannelError-Type (ECET)	Associated value AddValue	Diagnostics
0	0x0601	0x0681	0x00	Transmitted IO data invalid (partially bad-flagged)
0	0x0602	0x069C	0x00	Invalid BusAdapter on the PN/MF Coupler
0	0x0603	0x06A0	0x00	Error on other network
0	0x0603	0x06A1	Slot	Differences between the two networks at slot n
0	0x0603	0x06A2	0x00	No input data configured for the activated data validity display
0	0x0603	0x06A5	Slot	Shared Device conflict, invalid submodule assignment at slot n
0	0x0610	0x06B3	Number	Power supply fault (power supply number n)
0	0x0610	0x06B4	0x00	Diagnostics Undervoltage

Note

Only one diagnosis is reported at a time, even though there may be several causes for diagnosis.

See also

Block diagram (Page 34)

Parameters (Page 45)

5.3.2.2 Interrupts

The IO device initiates interrupts following certain errors. The evaluation of the interrupt is dependent on the IO controller used.

The PN/MF Coupler supports the following interrupts:

- Diagnostics interrupts

If the communication relation exists between the IO controller and the **PN/MF Coupler**, manufacturer-specific diagnostics of the PN/MF Coupler also become active as interrupts. The interrupts trigger the call of an OB 82 in a SIMATIC CPU.

Note

Start information of the OB

Diagnostics on the PN/MF Coupler can already be pending, which will not be reported by a diagnostics interrupt. You must then explicitly read the diagnostic information with a diagnostic data record in the user program.

Use the start information of OB 86, for example, and the list of the diagnostics and configuration data records

(<https://support.industry.siemens.com/cs/ww/en/view/19289930>) for PROFINET IO for this purpose.

- Maintenance alarms

The PN/MF Coupler supports diagnostics and the maintenance concept in PROFINET according to IEC 61158-6-10. The goal is to detect and remove potential problems as early as possible.

For the PN/MF Coupler, maintenance alarms signal to the user when a network component must be checked or replaced.

Maintenance alarms

The PN/MF Coupler signals a maintenance alarm to the higher-level diagnostics system when the following events occur:

Maintenance alarms	Event	Message/Meaning
Maintenance demanded <i>(maintenance demanded)</i> MT LED is lit	Loss of synchronization	<ul style="list-style-type: none"> • No synchronization message frame received <p>After parameterization or during operation, the sync master did not receive a synchronization message frame within the timeout period.</p> <ul style="list-style-type: none"> • Successive synchronization message frames are outside the permissible limits (jitter).
	Diagnostics Undervoltage	Undervoltage diagnostics applies when the power supply supplies a value from ≤ 19.2 V to ≥ 20.4 V.

System alarms in STEP 7

The maintenance information is generated in STEP 7 with the following system alarm:

- Maintenance demanded, identified by a yellow wrench icon at the relevant port.

5.3.2.3 Diagnostics readout

Options for reading out the diagnostic data

You can evaluate vendor-specific diagnostics using the corresponding data records (e.g. 0x800B) or using diagnostics interrupts.

Table 5- 12 Reading out the diagnostic data with STEP 7.

Automation system with IO controller	Application	See ...
SIMATIC S7	Diagnostics as plain text in STEP 7 in online and diagnostics view	Online help for STEP 7 and as of STEP 7 V 14 SIMATIC PROFINET Function Manual (https://support.industry.siemens.com/cs/ww/en/view/49948856)
	Instruction "RDREC" (SFB 52) Reading data records from the IO device	
	Instruction "RALRM" (SFB 54) Receiving alarms from the IO device	

Data status byte

Based on the data status byte (DS) value in the last byte, the user can recognize the following scenarios. Below you can find a description of the structure of the DS byte:

- 0x40: There is no valid coupling partner of the module input data in the other subnet.
- 0x60: The IO controller in the other subnet is in STOP state.
- 0x80 Valid user data received from coupling partner

Structure of the diagnostic data records

You can find the structure of the diagnostic data records and programming examples in the Programming Manual (<https://support.industry.siemens.com/cs/ww/en/view/19289930>) in sections Structure of the diagnostic data records and Examples for the diagnostic data records.

The data records supported by the PN/MF Coupler are based on the PROFINET IO standard - Application Layer Service Definition V2.0.

You can download the standard from the Internet free of charge (PROFIBUS (<https://www.profibus.com/>)).

5.3.2.4 Data validity display

Using the DIA parameter (data validity display), you query information about the validity of the input data supplied from the other bus side of the PN/MF Coupler directly in the user program.

See also

Parameters (Page 45)

5.3.2.5 STOP of the IO controller and recovery of the IO device

STOP of IO controller

The PN/MF Coupler indicates the STOP state of the IO controller of the other bus side using the optional "Data validity" diagnostics.

Diagnostics after STOP of the IO controller

If diagnostics are received from the IO device while the IO controller is in STOP state, the corresponding organization blocks are not initiated after startup of the IO controller. You must get an idea of the state of the IO device in OB 100. Evaluate the data status byte (DS) of the input modules in your user program.

Diagnostics after recovery of the IO device

Following recovery of an IO device, you must read data record E00CH with the "RDREC" instruction. This contains all the diagnostics data for the slots assigned to an IO controller in an IO device.

5.3.3 Reading service data

Service data

Service data for the PN/MF Coupler include:

- Fatal error information
- Device trace for X1 and X2 interface
- Device memory statistics

These are all cases where you can call Siemens Industry Online Support for help. Only Siemens Industry Online Support can evaluate this binary file.

STEP 7 V5.6 or higher

You can load the service data in STEP 7 as of V5.6 HF3. The service data is only available via the "Accessible devices".

See also

See the online help for STEP 7.

EtherNet/IP

6.1 EtherNet/IP functions

6.1.1 EtherNet/IP

The interface module supports the following EtherNet/IP functions:

- I/O communication with scanner
- Configuring from the user program
- Read diagnostics (interrupts are not supported)
- Normative CIP objects
- Resetting interface module to factory setting
- Diagnostics bit in data status of cyclic I/O data per submodule

6.2 Integration into the automation system

6.2.1 Overview

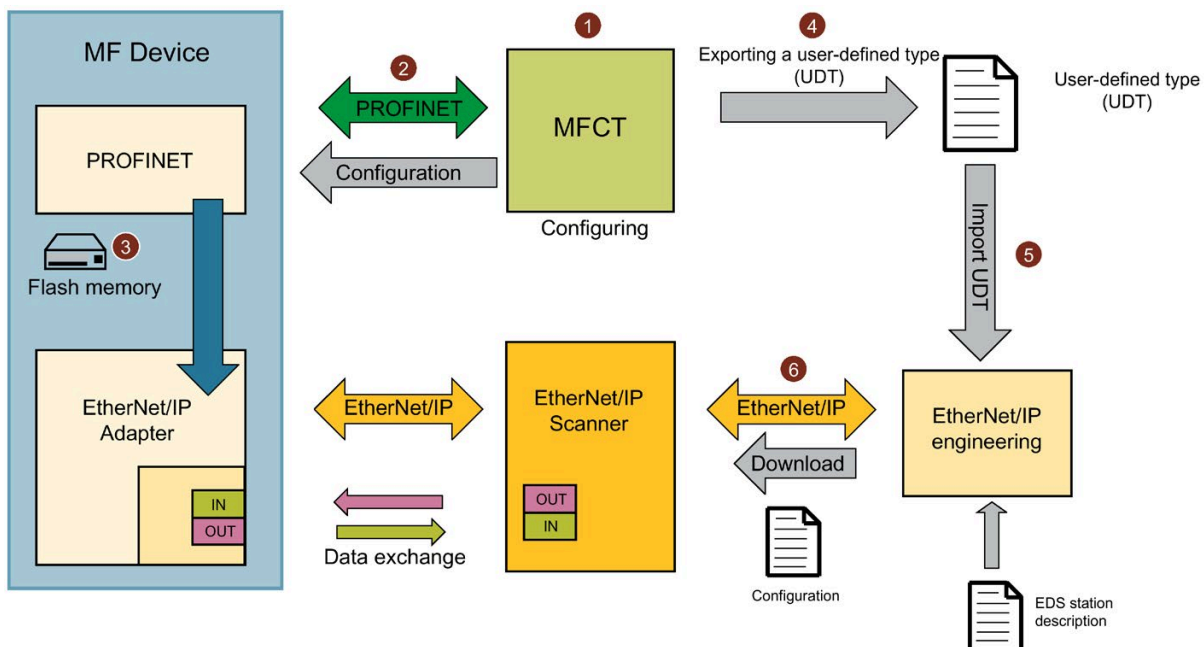

In the MultiFieldbus Configuration Tool (MFCT), configure the MF device and assign an IP address and a device name to the MF device ①. Then, download the configuration to the MF device with the PROFINET IO mechanisms ②. The configuration is saved on the MF device ③. Generate and export the I/O data mapping of the MF device as user-defined type (UDT) as I5x file for EtherNet/IP in MFCT ④. You then import the I5x file to your engineering system ⑤. Download the project to the Ethernet/IP scanner with the engineering system ⑥.

Import the generic EDS station description to your engineering system once.

Procedure

For commissioning, follow these steps:

1. Scan the network in MFCT and assign an IP address for the MF device.
2. Configure the MF device.
3. Select Ethernet/IP as fieldbus for the Ethernet interface.
4. Download the MultiFieldbus project to the MF device.
5. Export the I/O data mapping of the MF device as user-defined type (UDT) from MFCT.
6. Import the user-defined type (UDT) to your Ethernet/IP engineering system.
7. Configure the interface module in the Ethernet/IP engineering system.
8. Download the project to the Ethernet/IP scanner.
9. (Optional) Configure the modules from inside the user program.

Note

For MF devices, there might be modules displayed in engineering systems starting with slot 1000.

These merely reflect the retentively stored project in the MF device consisting of configuration and parameter assignment.

6.2.2 Configuring with MFCT

6.2.2.1 Settings

In the "Settings" tab, you can specify basic properties of the MultiFieldbus Configuration Tool:

- Select the user interface language.
- Select the network adapter.

You can also update the GSD file used.

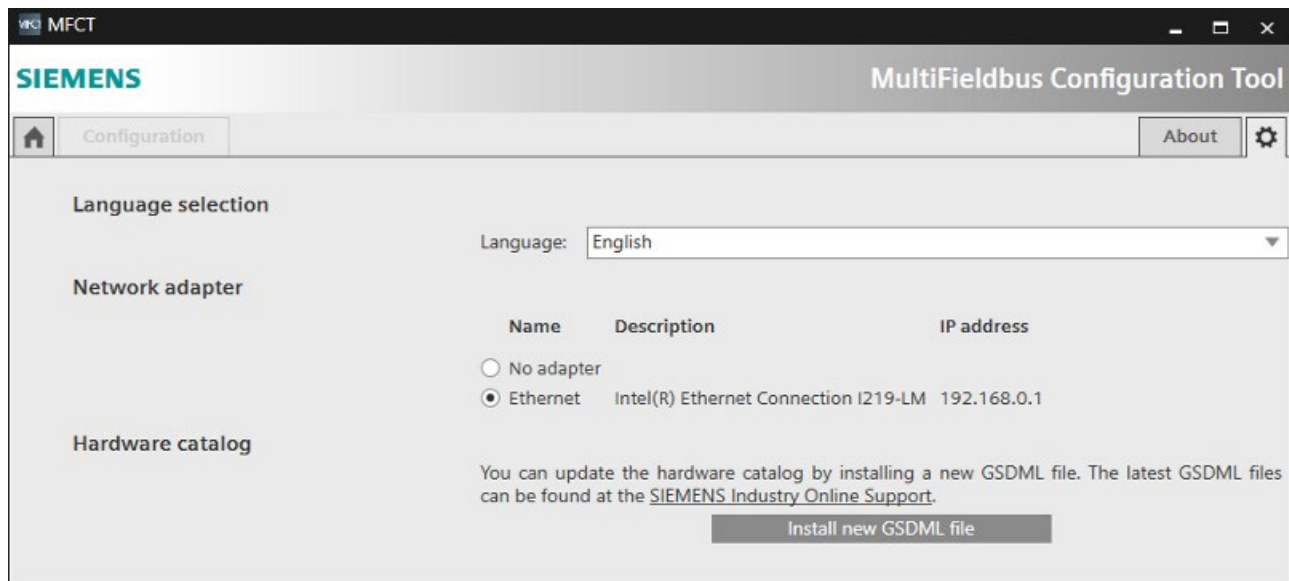

Language selection

Under "Language selection", select the user interface language for the MFCT.

Network adapter

Under "Network adapter", select the interface you want to use to connect to MF devices.

Hardware catalog

In the "Hardware catalog" section, you can update the GSD module description in the MFCT using the "Install new GSDML file" button.

To do this, proceed as follows:

1. Click the link in the text.
2. Download the zipped GSD file and save it locally.
3. Unzip the GSD file.
4. Click "Install new GSDML file" and select the unzipped GSD file.

6.2.2.2 Assigning network parameters

In the "Home" tab, you can assign the network parameters for MF devices under "Accessible MF devices":

1. Click "Start scan" to find MF devices via the preset network interface.
2. Select an MF device.
 - With "Flash LED", you can flash the LEDs of the MF device for identification.
3. Enter a device name, valid IP address and the subnet mask.
4. If you use a gateway, you can enable the "Use router for gateway" option and enter the router address.
5. Click "Assign network parameters".

The network parameters are assigned.

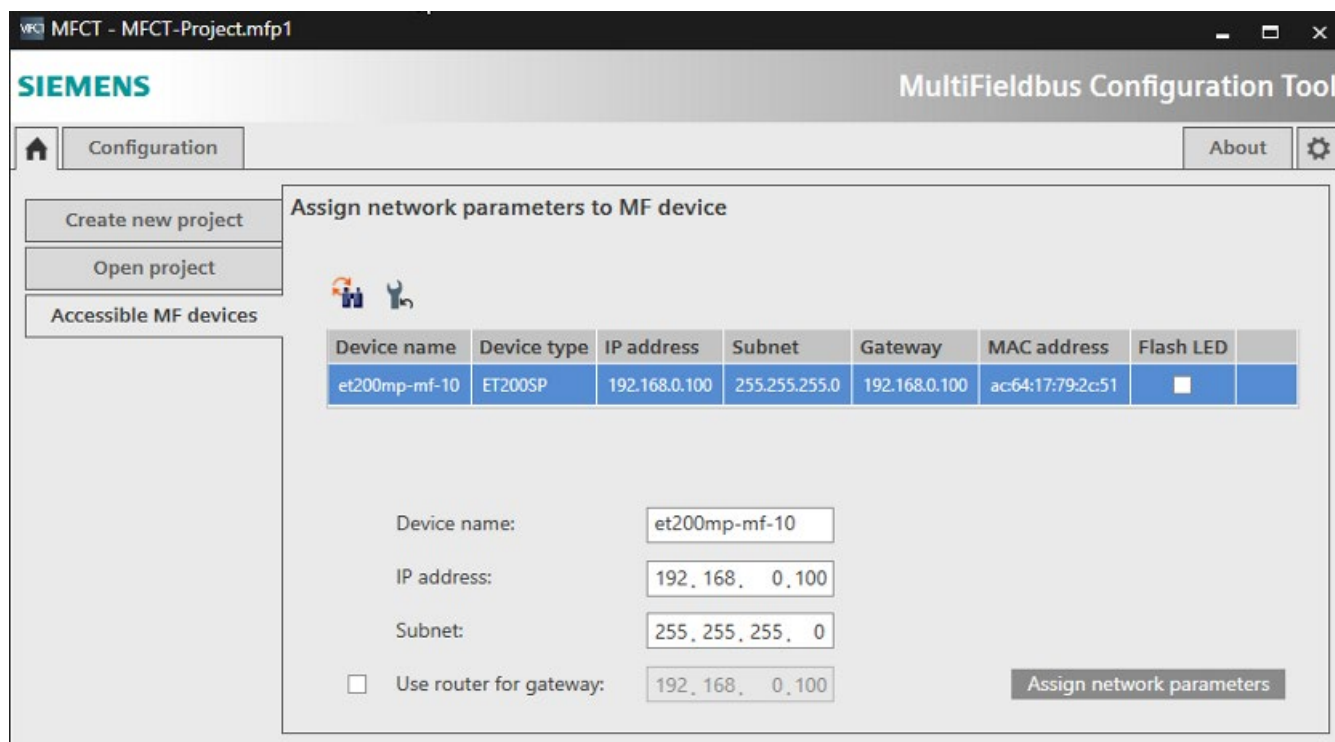

6.2.2.3 Resetting the MF device

On the "Home" tab, you can reset the MF device to factory settings under "Accessible MF devices":

1. Click "Start scan" to find MF devices via the preset network interface.
2. Select an MF device.
3. Click "Reset network parameters".

The network parameters and the MultiFieldbus project are deleted.

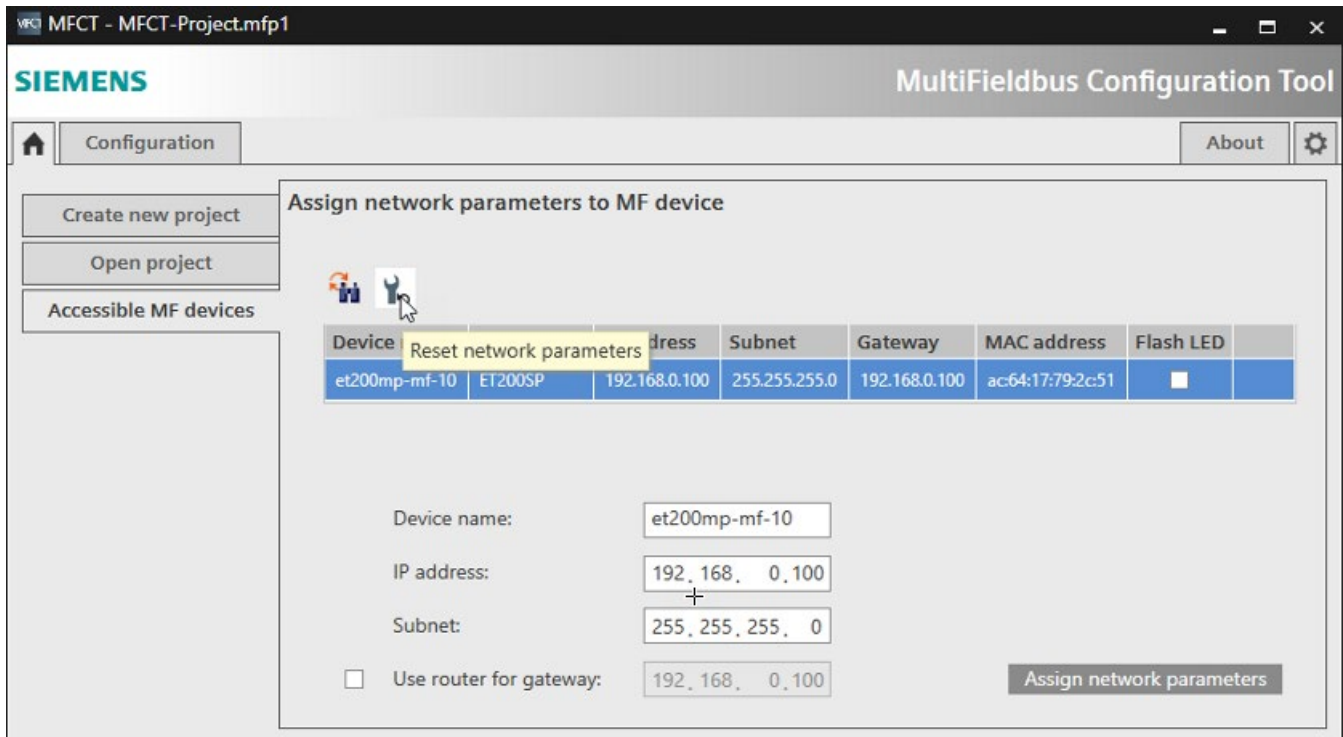

6.2.2.4 Creating new MultiFieldbus project in MFCT

You can create a new MultiFieldbus project in the "Home" tab:

1. Select "Create new project" and enter a name and a path for the new MF project.

Optionally, you can describe the project in more detail by entering the author and comments.

2. Click "Create project".

The MultiFieldbus project is created as a file with the extension ".mfp1". The MFCT then goes to the next step in the "Configuration" tab.

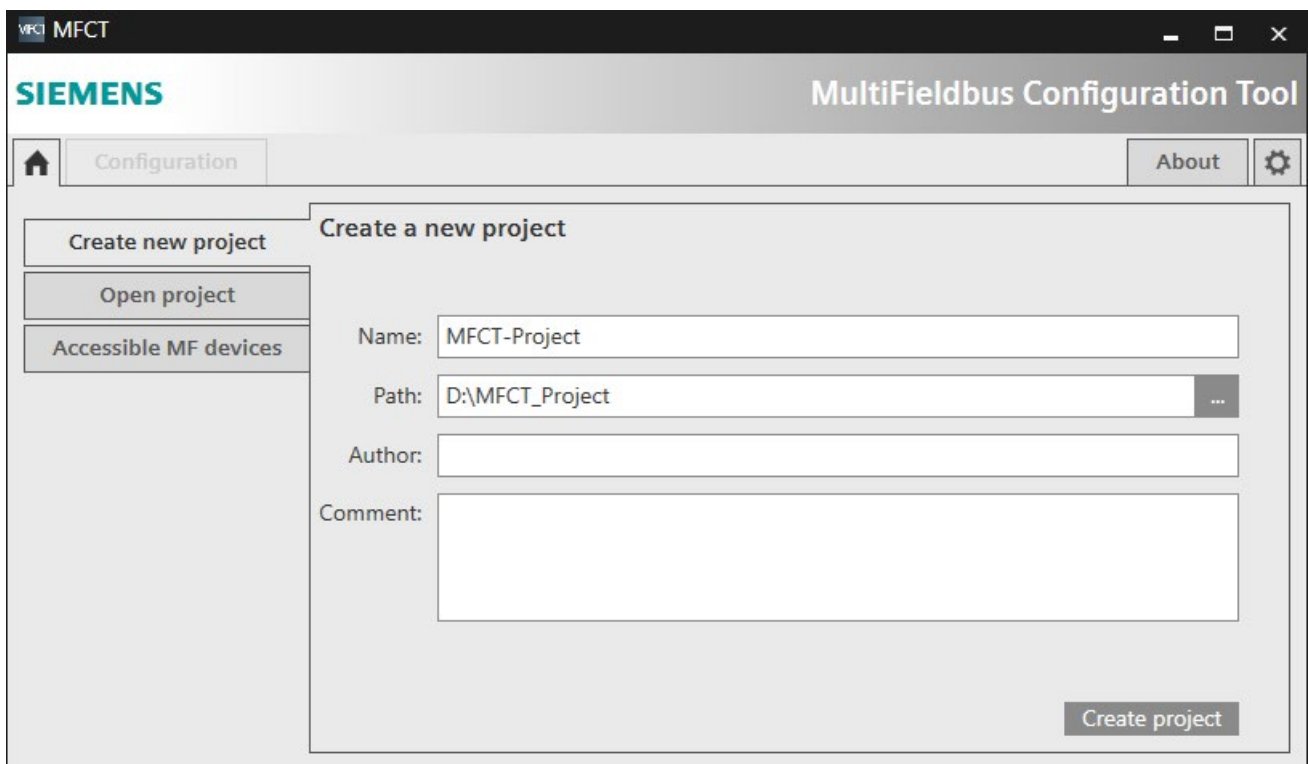

6.2.2.5 Open MultiFieldbus project in MFCT

You can open an existing MultiFieldbus project in the "Home" tab:

1. Select "Open project".
 - Under "Recently Used Projects", you can select a recently edited project and read it in directly by double-clicking it or using the "Open" button.
 - Alternatively, you can use the "Browse" button to open a project file.

The project is opened and the MFCT switches to the "Configuration" tab.

Note

The "Delete" button allows you to delete an existing project from the "Recently Used Projects" list. The project file itself is not deleted by this action.

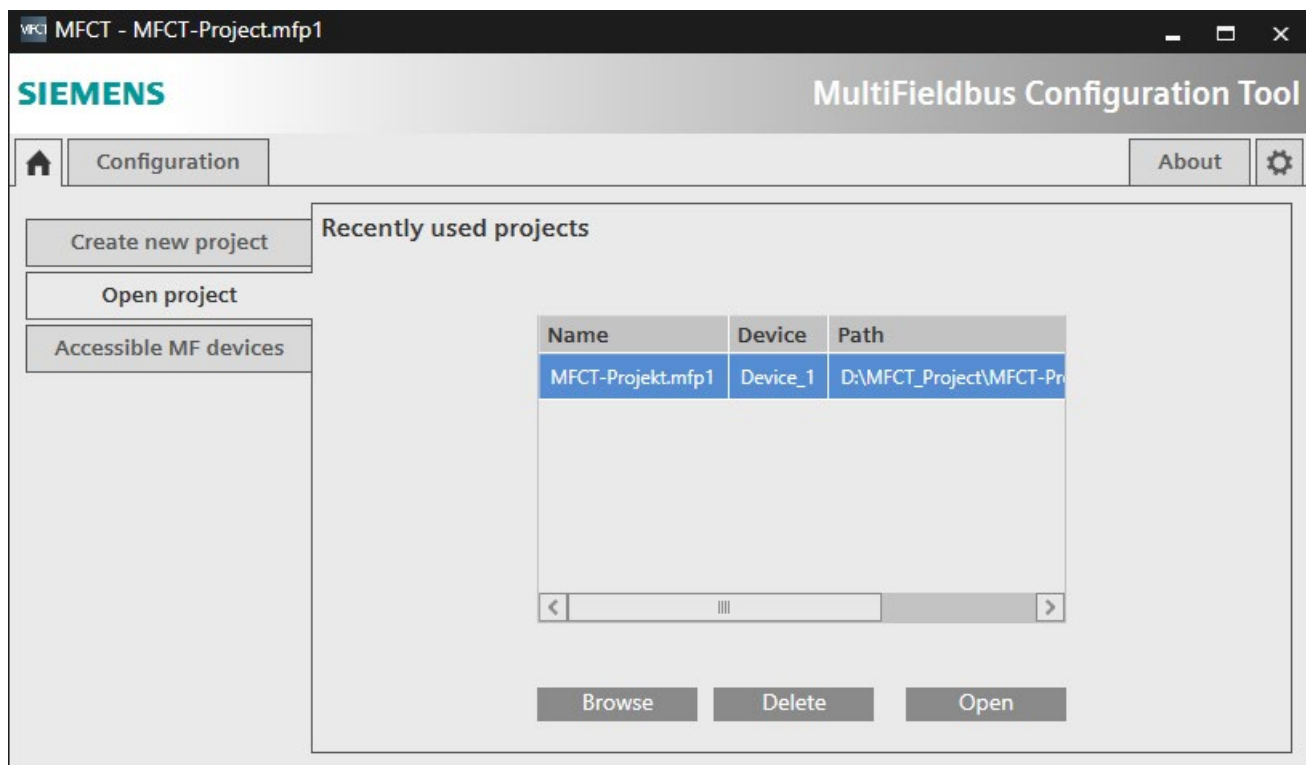

6.2.2.6 Selecting a station

You can create the configuration of the MF device in two ways:

- From the catalog if the real MF station is not available.
- From the network if the MF station is available online.

Selecting the MF device from the catalog

1. Select the "Catalogue" option under "Select MF device from".
2. Select the desired MF device, e.g. ET 200SP under "Select MF device".
3. Assign a name for the MF device under "Device name".
4. Select the desired interface module under "Short designation".
5. Click "Create Selected MF Device".

The MFCT automatically goes to the next step, "Configure Station".

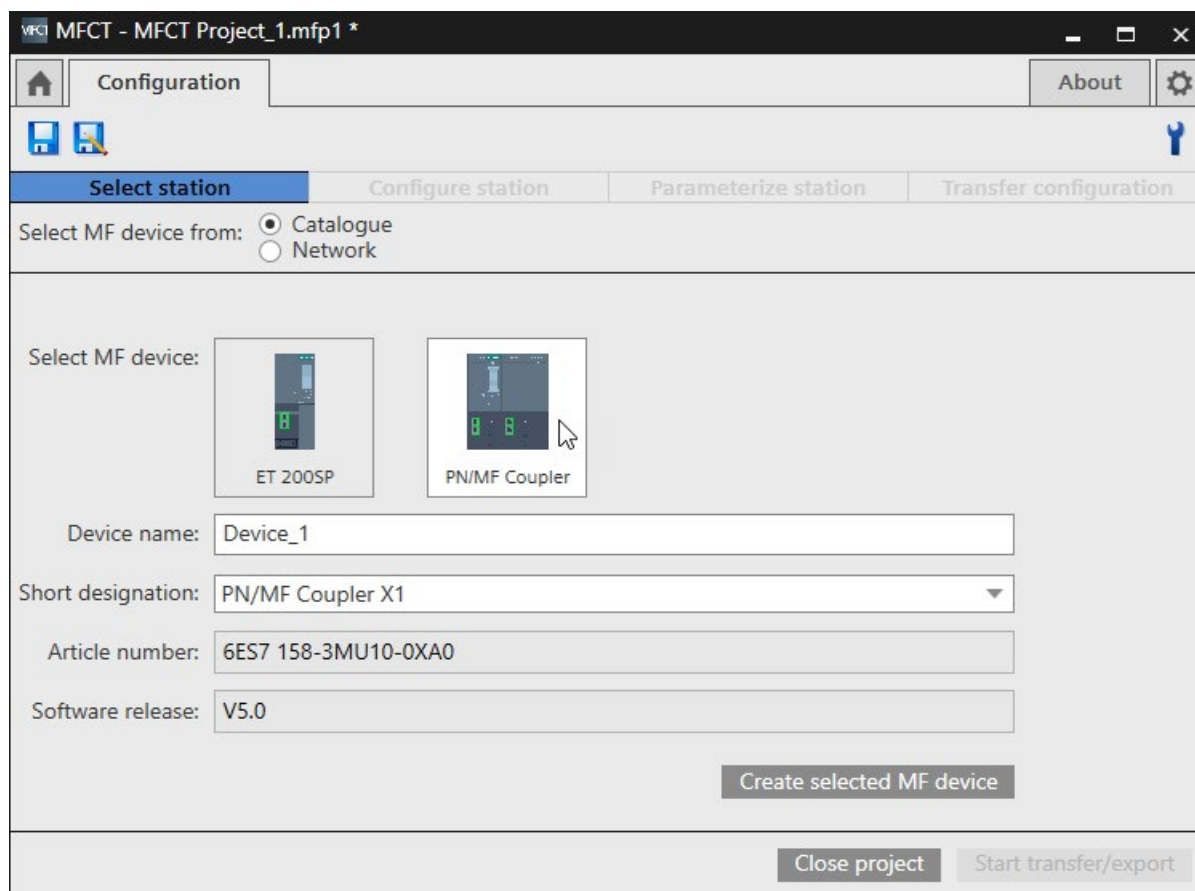

Selecting the MF device from the network and loading the configuration

1. Ensure that the network interface selected on the "Settings" tab is connected to the desired MF device.
2. Select the "Network" option under "Select MF device from".
3. Click "Start scan".
4. Select the desired MF device from the list. Devices without MultiFieldbus support cannot be selected and are grayed out.
5. Click "Create new project".

The current configuration is read out from the MF device and added to the MF project. MFCT then goes to the next step "Configure Station" for review and editing.

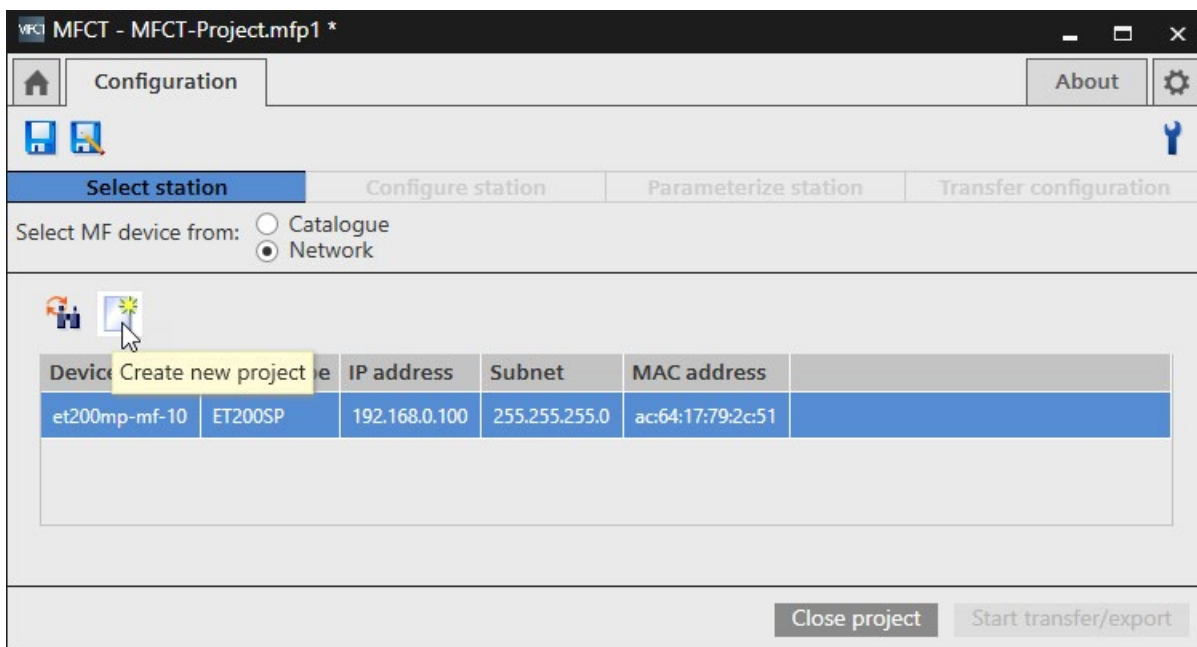

6.2.2.7 Configuring a station

Under "Configure Station", assemble the station with IO modules from the hardware catalog based on the GSDML.

The composition of the station is shown as a list on the left, sorted in ascending slot order. The IO modules of the hardware catalog based on the installed GSDML are shown on the right.

Additional information on the selected IO module is shown below the hardware catalog in the "Details" area.

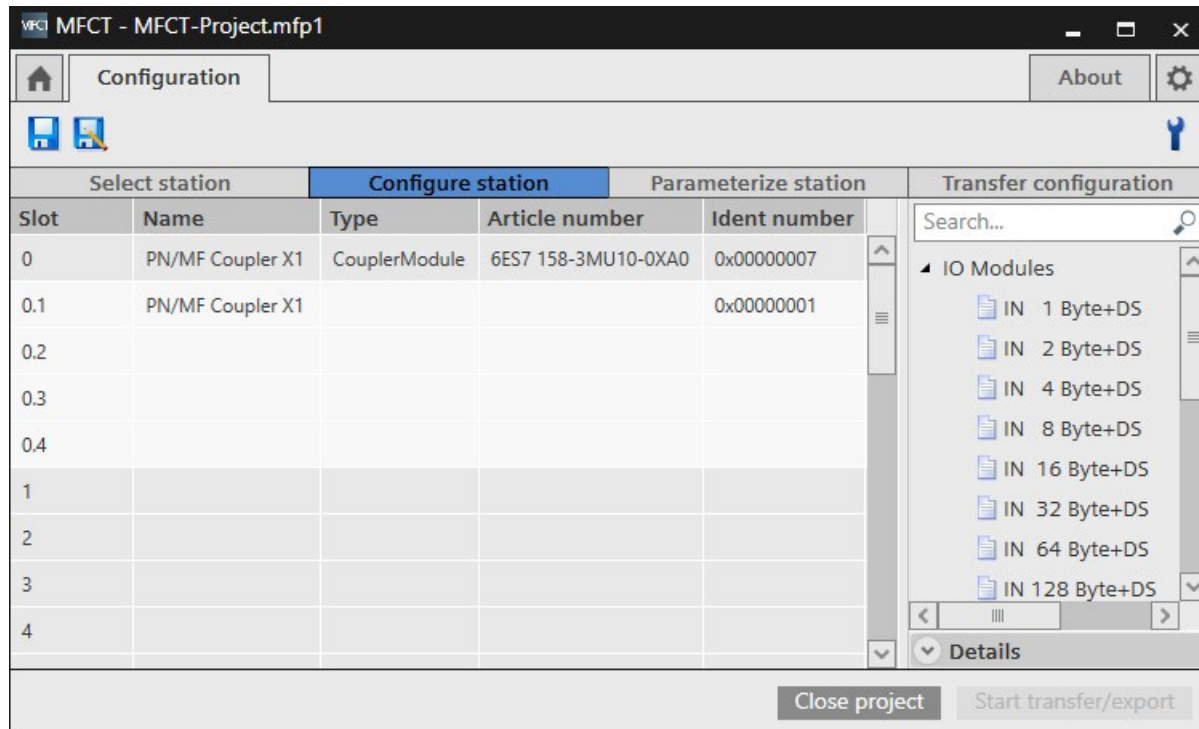

Selecting IO modules

1. Select the IO module from the hardware catalog for each slot and drag it onto the slot.

Note

The possible slots for the selected IO module are highlighted in green.

Deleting IO modules

1. Select the IO module to be deleted.
2. Click "Delete" in the shortcut menu.

1	OUT 64 Byte	Output		0x04400000
1.1	OUT 64 Byte			0x00000001
2	IN 64 Byte+DS	Input		0x00000440
2.1	IN 64 Byte+DS			0x00000001
3	OUT 1 Byte	Output		0x04010000

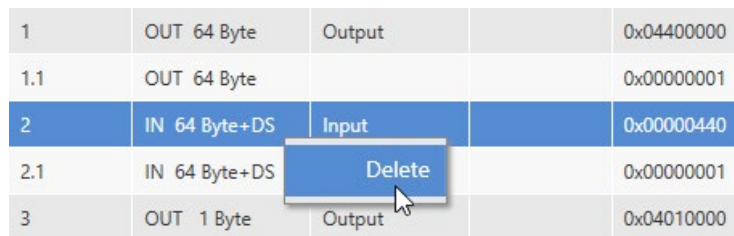

Example

Assuming that you want to read 128 bytes and write 64 bytes on network side X1 from network side X2, you need to configure the following for network side X1 in MFCT:

1	OUT 64 Byte	Output		0x04400000
1.1	OUT 64 Byte			0x00000001
2	IN 128 Byte+DS	Input		0x00000480
2.1	IN 128 Byte+DS			0x00000001

Information on how to configure network side X2 with STEP 7 (TIA Portal) with GSD file is available at "Configuring the PN/MF Coupler with GSD file (Page 41)".

6.2.2.8 Parameter assignment of the station

Under "Assign Station Parameters", set the parameters of the previously configured station. The composition of the station is shown as a list on the left, sorted in ascending slot order. The parameters for the MF device and the modules/submodules are shown on the right.

Procedure

1. Select the MF device on slot 0.
2. Select the desired fieldbus on the right under "Multi fieldbus parameters".
3. You can set a "Modbus hold time" from 1 ms to 30,000 ms. This parameter is not relevant for EtherNet/IP.
4. Use the "I/O data alignment" parameter to select "Byte" or "Word" for I/O data mapping (Page 75).
5. Assign parameters for the remaining modules and submodules by selecting the slot and setting the parameter values on the right side.

Multi fieldbus parameters		
Parameter	Value	Description
Fieldbus type	EtherNet/IP ▼	
Connection ID	0	
Modbus hold time [ms]	5000	
I/O data alignment	Byte ▼	

6.2.2.9 Transfer the configuration

The "Transfer configuration" area offers you the following options:

- Download the project to the MF device.
- Export the configuration for use in other engineering tools.

Downloading the project to the MF device

To transfer the MF project to the MF device, follow these steps:

1. Select the "Transfer the project to the MF device" check box.
2. Click "Start scan" to scan for MF devices via the preset network interface for the project download. Devices without MultiFeldbus support cannot be selected and are grayed out.
3. Select an MF device and start the download to the MF device using the "Start transfer/export" button.

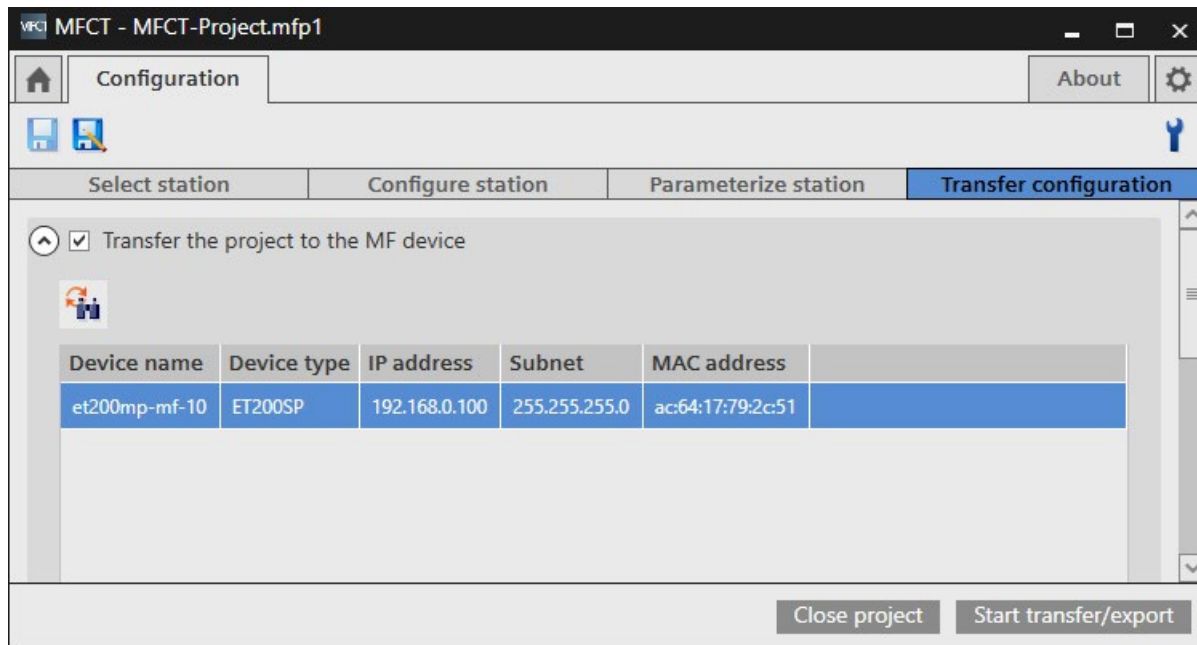

Fault rectification of the timeout on transfer to the MF device

- Check the accessibility of the MF device via the network interface selected in MFCT.
- Terminate the connection of the MF device to PROFINET IO controllers.
- If you have selected the "Use router for gateway" option in the network parameters, check the network parameters of the device.

Export of configuration

1. Select the "Export configuration for use in other engineering tools" check box.
2. Assign a name and a path for the export
3. Select the file formats to be exported:
 - MultiFieldbus Configuration Tool (MFCT) project
 - User Defined Data Type (UDT) (as I5x file)
 - Comma Separated Values (CSV)
 - Electronic Data Sheet (EDS)
4. Start the export using the "Start transfer/export" button.

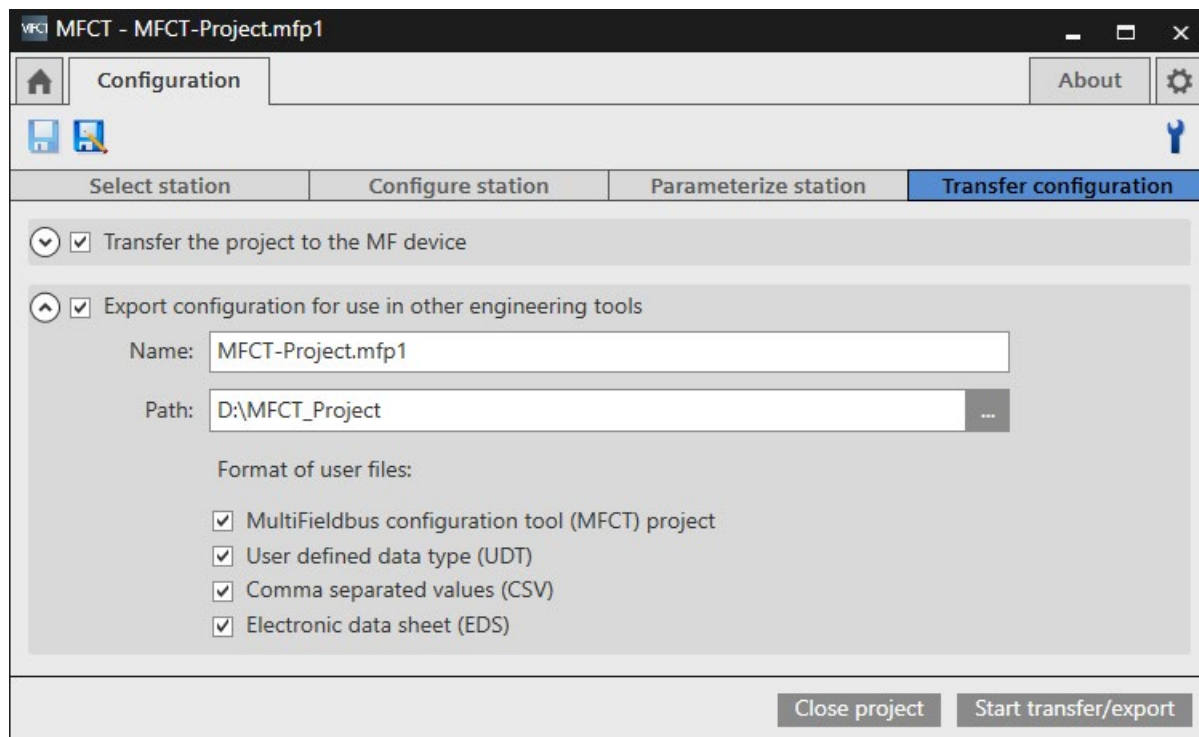

Transfer/export status

The progress and result of the file export and project download are each displayed. The fieldbus selected in the MF device as well as any differences between the configured and real hardware are also displayed.

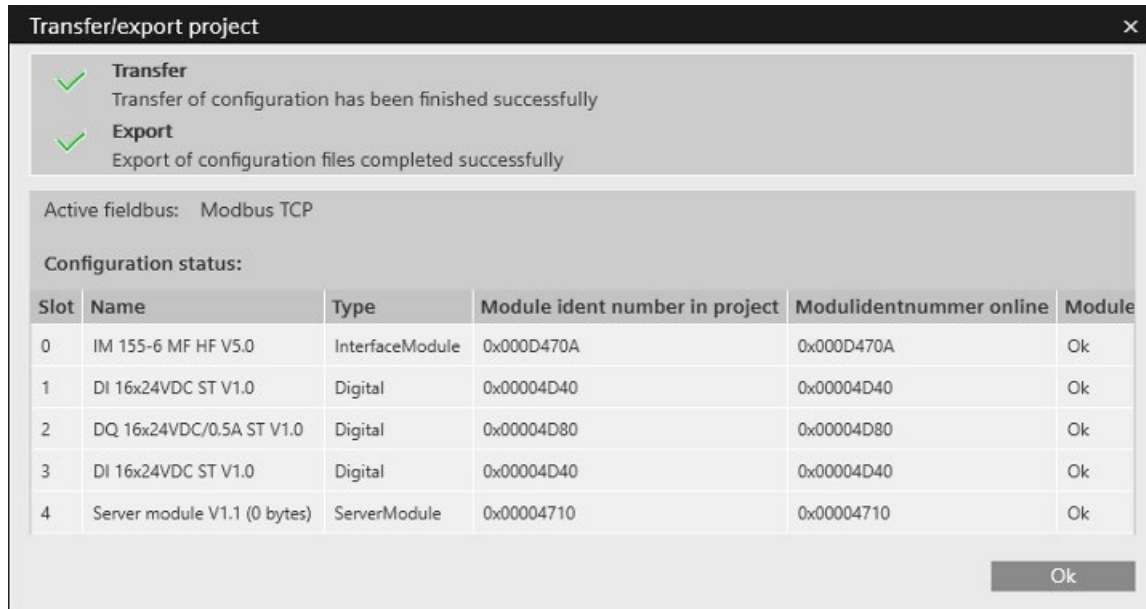

6.2.3 Configuration in the engineering system

6.2.3.1 Configuration in the engineering system

You can export the EDS station description and the User Defined Type (UDT) that you need for the configuration in the engineering system for EtherNet/IP using MFCT. If no other directory was selected during export, the files are located in the directory of the MFCT project.

Alternatively, the EDS station description can also be found in the installation directory of MFCT.

6.2.3.2 Import EDS station description

To import the EDS station description into the engineering system, proceed as described in the documentation of the engineering system.

6.2.3.3 Importing a user-defined type (UDT)

To import the user-defined type (UDT) as an I5x file into the engineering system, proceed as described in the documentation of the engineering system.

6.2.3.4 Configuring the interface module

To configure the interface module, follow these steps:

1. Create a new module under "Ethernet" with the "New module" shortcut menu.
2. Select the module type from the catalog and click "Create".
3. Assign a name and IP address under "General".
4. Click "Change" and adjust the input and output sizes to the station configuration.

Note

Because there are engineering systems that can only manage one EDS station description per device type, the maximum possible input and output sizes for the device type are modeled in the EDS station description.

For the specific station configuration, you can reduce the input and output sizes of a device instance to the byte length described in the User Defined Type (UDT) in order to optimize the bandwidth needed in the network.

6.2.3.5 Configuring the module from the user program

Module-specific data records can be read/written as explicit messages from the user program.

You can find information on the structure of the data records, for example, in the manual of the respective module (<https://support.industry.siemens.com/cs/ww/en/view/109742709>).

Message Type	CIP Generic
Service Code	0x32 = ReadRecord 0x33 = WriteRecord
Class	0x66 (param object)
Instance ID	Slot/subslot is coded in the instance ID: Slot number x 256 + Subslot number (access to subslots of the interface module [1, 0x8000, 0x8001, 0x8002] with subslot number [1...4])
Instance Attribute	Record index (see table below)
Source	Param Object Request (length and parameter data record) (Page 104)
Destination	Param Object Response (length and parameter data record) (Page 104)

Table 6- 1 Record index

Record type	Record index range	Access via CIP Message
User-specific records	0x0000...0x7FFF	Read/write
Normative PROFINET records		0x8000...0xAFF0
	I&M1...3	0xAFF1...0xAFF3
		0xAFF4...0xFFFF
		Read-only

Example

The following example shows how you read 6 bytes from slot 3 with parameter data record 128.

Table 6- 2 CIP Request:

Field	Value	Description
Message Type	CIP Generic	
Service Code	0x32	Read Record
Class	0x66	Param Object
Instance ID	0x301	Slot 3 and Subslot 1
Instance Attribute	128	Record Index
Source Length	4	CIP Request Length
Source Element	0x00, 0x00, 0x00, 0x06	Record Request Length

Table 6- 3 CIP Response:

Field	Value	Description
Destination Element	0x00, 0x00, 0x00, 0x06	Record Response Length
	0x01, 0x02, 0x03, 0x04, 0x05, 0x06	Record Response Data

Example

The following example shows how you read 4 bytes from slot 0 with parameter data record 128.

Table 6- 4 CIP Request:

Field	Value	Description
Message Type	CIP Generic	
Service Code	0x32	Read Record
Class	0x66	Param Object
Instance ID	0x0001	Slot 0 and Subslot 1
Instance Attribute	1	Record Index
Source Length	4	CIP Request Length
Source Element	0x00, 0x00, 0x00, 0x04	Record Request Length

Table 6- 5 CIP Response:

Field	Value	Description
Destination Element	0x00, 0x00, 0x00, 0x04	Record Response Length
	0x01, 0x02, 0x03, 0x04	Record Response Data

6.2.3.6 I/O data mapping

I/O data mapping

During parameter assignment of the MF device (Page 69), you can choose between two formats for the I/O data mapping:

- With the "Byte" format, the input or output data of the modules of an I/O connection are lined up by increasing slot number (Slot.Subslot).
- With the "Word" format, the input or output data of the modules of an I/O connection are lined up by increasing slot number (Slot.Subslot). If the submodule has an odd data length, a fill byte (content 0x00) is inserted after the submodule. This aligns the following data status bytes (IDS, ODS) to word limits. A padding byte (content 0x00) is also inserted after the data status byte (IDS, ODS). Subsequent submodules will then also start at an even byte offset.

The image of the outputs contains only the output data (with padding bytes if necessary), while the input image also supplies additional status bytes together with the input data (with padding bytes if necessary).

An Output Data Status Byte (ODS) is available for each output submodule in the image of the inputs.

There is an Input Data Status Byte (IDS) for each input submodule that follows the respective input data of the submodule in the input image.

Submodules with a data length of 0 for input and output data are treated as input submodules. Only an Input Data Status Byte (IDS) is entered in the input image.

Note

You can find the I/O data mapping for your configuration in the exported CSV file (Page 70).

I/O data status

The following table shows the coding of the status bytes for IDS and ODS:

Field	Bit number	Bit mask	De-fault	Bit value = '0'	Bit value = '1'
IOValid	7	0x80	0	I/O data invalid	I/O data valid*
Problem	6	0x40	0	Initialstatus	Module problem: <ul style="list-style-type: none"> • Module not plugged • Incorrect module plugged • Module with incorrect parameter assignment • I/O data temporarily invalid after station startup
Reserved	5...1	0x2E	00000	-	
Diagnostics	0	0x01	0	No diagnostics	Diagnostics available

* With the PN/MF Coupler, output data is always displayed as valid (ODS = 0x80).

6.2 Integration into the automation system

If the PROFINET communication of coupled modules fails on the X2 interface, EtherNet/IP input data is reset to zero and the IDS data status is set to BAD.

Note

For MSI and MSO submodules, the IDS.Diagnosis bit is 0. Comparable to the diagnostics interrupt of PROFINET, the diagnostics for MSI and MSO are only signaled in the IDS.Diagnosis bit for the default submodule (subslot = 1).

6.2.3.7 Example of I/O data mapping for I/O data alignment Byte

Configuration example

The example uses the following IO modules:

Slot	Module/IO module
0	PN/MF Coupler X1
1	OUT 2 Byte
2	IN 1 Byte+DS
3	OUT 2 Byte
4	OUT 1 Byte
5	IN 2 Byte+DS
6	PROFIsafe IN/OUT 6 Byte / 12 Byte

Input buffer

The following table shows the input buffer for the example configuration for the I/O data alignment Byte:

Slot	Name*	Data type	Byte offset	Description
0	Slot0_1_Id_0_IDS	Byte	0	Input Data State for the PN/MF Coupler
2	Slot2_1_Id_0_Inputs	Byte	1	IN 1 Byte+DS
	Slot2_1_Id_1_IDS	Byte	2	Input Data State for IN 1 Byte+DS
5	Slot5_1_Id_0_Inputs	Byte	3	IN 2 Byte+DS
	Slot5_1_Id_1_Inputs	Byte	4	
	Slot5_1_Id_2_IDS	Byte	5	Input Data State for IN 2 Byte+DS
6	Slot6_1_Id_0_Inputs	Byte	7	PROFIsafe IN/OUT 6 Byte / 12 Byte
	Slot6_1_Id_1_Inputs	Byte	8	
	Slot6_1_Id_2_Inputs	Byte	9	
	Slot6_1_Id_3_Inputs	Byte	10	
	Slot6_1_Id_4_Inputs	Byte	11	
	Slot6_1_Id_5_Inputs	Byte	12	
	Slot6_1_Id_6_IDS	Byte	13	Input Data State for PROFIsafe IN/OUT 6 Byte / 12 Byte
1	Slot1_1_Id_0_ODS	Byte	14	Output Data State for OUT 2 Byte
3	Slot3_1_Id_0_ODS	Byte	15	Output Data State for OUT 2 Byte
4	Slot4_1_Id_0_ODS	Byte	16	Output Data State for OUT 1 Byte
6	Slot6_1_Id_0_ODS	Byte	17	Output Data State for PROFIsafe IN/OUT 6 Byte / 12 Byte

The sum of the input data is 18 bytes.

Output buffer

The following table shows the output buffer for the example configuration for the I/O data alignment Byte:

Slot	Name*	Data type	Byte offset	Description
1	Slot1_1_Id_0_Outputs	Byte	0	OUT 2 Byte
	Slot1_1_Id_1_Outputs	Byte	1	
3	Slot3_1_Id_0_Outputs	Byte	2	OUT 2 Byte
	Slot3_1_Id_1_Outputs	Byte	3	
4	Slot4_1_Id_0_Outputs	Byte	4	OUT 1 Byte
	Slot6_1_Id_0_Outputs	Byte	5	PROFIsafe IN/OUT 6 Byte / 12 Byte
	Slot6_1_Id_1_Outputs	Byte	6	
	Slot6_1_Id_2_Outputs	Byte	7	
	Slot6_1_Id_3_Outputs	Byte	8	
	Slot6_1_Id_4_Outputs	Byte	9	
	Slot6_1_Id_5_Outputs	Byte	10	
	Slot6_1_Id_6_Outputs	Byte	11	
	Slot6_1_Id_7_Outputs	Byte	12	
	Slot6_1_Id_8_Outputs	Byte	13	
	Slot6_1_Id_9_Outputs	Byte	14	
	Slot6_1_Id_10_Outputs	Byte	15	
	Slot6_1_Id_11_Outputs	Byte	16	
-	-	Byte	17	Reserved

* The name is formed according to the following scheme: Slot<Slot#>_<Subslot#>_Id_<Id#>_<DataItem-TextId>

The sum of the output data is 18 bytes.

6.2.3.8 Example of I/O data mapping for I/O data alignment Word

Configuration example

The example uses the following IO modules:

Slot	Module/IO module
0	PN/MF Coupler X1
1	OUT 2 Byte
2	IN 1 Byte+DS
3	OUT 2 Byte
4	OUT 1 Byte
5	IN 2 Byte+DS
6	PROFIsafe IN/OUT 6 Byte / 12 Byte

Input buffer

The following table shows the input buffer for the example configuration for the I/O data alignment Word:

Slot	Name*	Data type	Byte offset	Description
0	Slot0_1_Id_0_IDS	Byte	0	Input Data State for the PN/MF Coupler
	Slot0_1_Id_1_Padding	Byte	1	<i>Padding byte</i>
2	Slot2_1_Id_0_Inputs	Byte	2	IN 1 Byte+DS
	Slot2_1_Id_1_Padding	Byte	3	<i>Padding byte</i>
	Slot2_1_Id_2_IDS	Byte	4	Input Data State for IN 1 Byte+DS
	Slot2_1_Id_3_Padding	Byte	5	<i>Padding byte</i>
5	Slot5_1_Id_0_Inputs	Byte	6	IN 2 Byte+DS
	Slot5_1_Id_1_Inputs	Byte	7	
	Slot5_1_Id_2_IDS	Byte	8	Input Data State for IN 2 Byte+DS
	Slot5_1_Id_3_Padding	Byte	9	<i>Padding byte</i>
6	Slot6_1_Id_0_Inputs	Byte	10	PROFIsafe IN/OUT 6 Byte / 12 Byte
	Slot6_1_Id_1_Inputs	Byte	11	
	Slot6_1_Id_2_Inputs	Byte	12	
	Slot6_1_Id_3_Inputs	Byte	13	
	Slot6_1_Id_4_Inputs	Byte	14	
	Slot6_1_Id_5_Inputs	Byte	15	
	Slot6_1_Id_6_IDS	Byte	16	Input Data State for PROFIsafe IN/OUT 6 Byte / 12 Byte
Slot6_1_Id_7_Padding	Byte	17	<i>Padding byte</i>	
1	Slot1_1_Id_0_ODS	Byte	18	Output Data State for OUT 2 Byte
	Slot1_1_Id_1_Padding	Byte	19	<i>Padding byte</i>
3	Slot3_1_Id_0_ODS	Byte	20	Output Data State for OUT 2 Byte
	Slot3_1_Id_1_Padding	Byte	21	<i>Padding byte</i>
4	Slot4_1_Id_0_ODS	Byte	22	Output Data State for OUT 1 Byte
	Slot4_1_Id_1_Padding	Byte	23	<i>Padding byte</i>
6	Slot6_1_Id_8_ODS	Byte	24	Output Data State for PROFIsafe IN/OUT 6 Byte / 12 Byte
	Slot6_1_Id_9_Padding	Byte	25	<i>Padding byte</i>

The sum of the input data is 26 bytes.

Output buffer

The following table shows the output buffer for the example configuration for the I/O data alignment Word:

Slot	Name*	Data type	Byte offset	Description
1	Slot1_1_Id_0_Outputs	Byte	0	OUT 2 Byte
	Slot1_1_Id_1_Outputs	Byte	1	
3	Slot3_1_Id_0_Outputs	Byte	2	OUT 2 Byte
	Slot3_1_Id_1_Outputs	Byte	3	
4	Slot4_1_Id_0_Outputs	Byte	4	OUT 1 Byte
	Slot4_1_Id_1_Padding	Byte	5	<i>Padding byte</i>
6	Slot6_1_Id_0_Outputs	Byte	6	PROFIsafe IN/OUT 6 Byte / 12 Byte
	Slot6_1_Id_1_Outputs	Byte	7	
	Slot6_1_Id_2_Outputs	Byte	8	
	Slot6_1_Id_3_Outputs	Byte	9	
	Slot6_1_Id_4_Outputs	Byte	10	
	Slot6_1_Id_5_Outputs	Byte	11	
	Slot6_1_Id_6_Outputs	Byte	12	
	Slot6_1_Id_7_Outputs	Byte	13	
	Slot6_1_Id_8_Outputs	Byte	14	
	Slot6_1_Id_9_Outputs	Byte	15	
	Slot6_1_Id_10_Outputs	Byte	16	
	Slot6_1_Id_11_Outputs	Byte	17	

* The name is formed according to the following scheme: Slot<Slot#>_<Subslot#>_Id_<Id#>_<DataItem-TextId>

The sum of the output data is 18 bytes.

6.3 Diagnostics

6.3.1 Status and error displays for EtherNet/IP

RN/NS, ER/MS, MT/IO LEDs on the MF device

The LEDs display the status with the highest priority if there are different LED states due to overlaid events. (0 = off, 1 = green flashing, 2 = green, 3 = yellow, 4 = red flashing, 5 = red)

The following table shows the meaning of the RN/NS, ER/MS LEDs and MT/IO LEDs for EtherNet/IP:

Table 6- 6 Status and error displays of the RN/NS LED



LED	Meaning	Remedy
RN/NS (NET STATUS)		
 Flashes	The MF device is not exchanging data.	<ul style="list-style-type: none"> • Check the correctness of the download with MFCT and for a valid IP address. • Establish the cyclic communication with the EtherNet/IP scanner.
 On	The MF device is exchanging data via at least one connection.	---
 Flashes	Timeout	<ul style="list-style-type: none"> • Check the accessibility of the device via the network from the perspective of the EtherNet/IP scanner.

Table 6-7 Status and error displays of the ER/MS LED

LED	Meaning	Remedy
ER/MS (MODUL STATUS)		
□ Off	There is no MultiFieldbus project in the MF device.	<ul style="list-style-type: none"> • Create a project with MFCT and transfer it to the MF device.
☀ Flashes	The MF device is not exchanging data. There is a MultiFieldbus project in the MF device.	<ul style="list-style-type: none"> • Establish the cyclic communication with the EtherNet/IP scanner.
■ On	The MF device is in data exchange mode over a connection.	---
☀ Flashes	<ul style="list-style-type: none"> • There is a diagnostics. • Errors in the configuration or parameter assignment. (In this state ignore the LED MT/IO)	<ul style="list-style-type: none"> • Check for diagnostics information and, if necessary, eliminate the error. • Check the configuration of the MF station and, if necessary, correct the configuration and parameter assignment of the MF device in the MFCT and download them to the MF device again.

Table 6-8 Status and error displays of the MT/IO LED























LED	Meaning	Remedy
MT/IO (IO STATUS)		
□ Off	There is no MultiFieldbus project in the MF device, or I/O that is used by EtherNet/IP is in STOP. There is no error.	<ul style="list-style-type: none"> • Switch the EtherNet/IP scanner to RUN mode.
■ On	I/O used by EtherNet/IP is in RUN mode.	---
☀ Flashes	A diagnostic result is available for the I/O or modules used by EtherNet/IP are missing.	<ul style="list-style-type: none"> • Check the configuration of the MF station and, if necessary, correct the configuration and parameter assignment of the modules in the MFCT and download them to the MF device again. • Check for I/O diagnostics information and, if necessary, eliminate the error.
■ On	There is a maintenance event	<ul style="list-style-type: none"> • You will find further information in "Interrupts (Page 55)."

Combinations of the RN/NS, ER/MS, MT/IO LEDs on the MF device

Combinations of the three LEDs are possible. The following table shows the possible combinations:

Table 6-9 Status and error displays of the RN/NS, ER/MS, MT/IO LEDs

LEDs			Meaning	Notes
RN/NS (NET STATUS)	ER/MS (MODUL STATUS)	MT/IO (IO STATUS)		
□ Off	□ Off	□ Off	Missing or insufficient supply voltage on the MF device.	<ul style="list-style-type: none"> Check the supply voltage or switch on the supply voltage on the MF device.*
☀ Flashes	□ Off	□ Off	The MF device is not exchanging data. There is no MultiFieldbus project in the MF device.	<ul style="list-style-type: none"> Create a project with MFCT and transfer it to the MF device. Then establish the cyclic I/O communication with the MF device.
■ On	□ Off	□ Off	The MF device is exchanging data via PROFINET IO. There is no MultiFieldbus project in the MF device.	<ul style="list-style-type: none"> Exclusive PROFINET use
☀ Flashes	☀ Flashes	□ Off	The MF device is not exchanging data. There is a MultiFieldbus project in the MF device.	<ul style="list-style-type: none"> Establish the cyclic communication via EtherNet/IP.
■ On	■ On	□ Off	The MF device is exchanging data error-free via a connection (EtherNet/IP).	<ul style="list-style-type: none"> If a data exchange was configured for EtherNet/IP, the assigned EtherNet/IP scanner is in STOP mode.
■ On	■ On	■ On	The MF device is exchanging data error-free via a connection (EtherNet/IP). I/O used by EtherNet/IP is in RUN mode.	---
■ On	☀ Flashes	■ On or □ Off	The MF device is exchanging data via at least one connection. Errors in the configuration or parameter assignment.	<ul style="list-style-type: none"> At least one module is configured incorrectly, there is no missing module or I/O diagnostics information. Check the station configuration and, if necessary, correct the configuration and parameter assignment of the MF device in the MFCT and download them to the MF device again. Check the device status in the Device-Info area and, if necessary, eliminate the diagnostics error.

LEDs			Meaning	Notes
RN/NS (NET STATUS)	ER/MS (MODUL STATUS)	MT/IO (IO STATUS)		
 Flashes	 Flashes	 Off	The MF device is not exchanging data. There is an MF device fault.	<ul style="list-style-type: none"> Establish the cyclic communication via the I/O register area of the MF device or via EtherNet/IP. Check the station configuration and eliminate configuration and parameter assignment errors via MFCT and eliminate diagnostics errors.
 On	 Flashes	 Flashes	The MF device is exchanging data error-free via a connection (EtherNet/IP). There is diagnostics information for the I/O.	<ul style="list-style-type: none"> Check the station configuration for I/O modules assigned for EtherNet/IP and eliminate I/O diagnostics errors or insert missing I/O modules.
 Flashes	 Flashes	Not relevant	At least one connection existed (EtherNet/IP). A connection has been terminated by timeout.	<ul style="list-style-type: none"> Reduce the cycle time. Check the accessibility of the MF device via the network from the perspective of the EtherNet/IP scanner.
 Flashes	 Flashes	 Flashes	At least one connection existed (EtherNet/IP or Modbus TCP). A connection has been terminated by timeout. Error in the configuration or parameter assignment, or there is PROFINET IO diagnostics information.	<ul style="list-style-type: none"> Check the accessibility of the MF device via the network from the perspective of the EtherNet/IP scanner. Check the station configuration and eliminate configuration and parameter assignment errors via MFCT and eliminate diagnostics errors.
 Flashes	 Flashes	 Flashes	The "Node flash test" is running.	<ul style="list-style-type: none"> The LK1 and LK2 LEDs of the EtherNet interface are also flashing.
 Flashes	 Flashes	 Flashes	Hardware or firmware defective.	<ul style="list-style-type: none"> You can read out the service data with STEP 7 V5.6.
 Flashes	 Flashes	 Flashes	Test of LEDs during startup: The three LEDs light up yellow simultaneously for approximately 0.25 s. Then for approximately 0.25 s in green.	---
 On	 On	 On	RN/NS-, ER/MS-, MT/IO-LEDs are permanently on: Hardware or firmware defective. Error information will be determined and stored retentively on the Flash memory.	Do not disconnect the interface module from the supply voltage while the LEDs are permanently lit up. This may take a few minutes.

* PWR LED On (on MF device): Check the backplane bus for short-circuit.

6.3.2 Reading diagnostics via CIP EtherNet/IP

You can read out the diagnostics of MF devices or modules via the CIP Param Object.

To do this, call the Param Object (Page 104) with the ReIndex 0x800C Read (ReadRecord (0x32)).

The diagnostics responds with the following structure:

DiagnosisData

Field	Size	Description
BlockHeader		
BlockType	Unsigned16	0x0010 = DiagnosisData
BlockLength	Unsigned16	
BlockVersionHigh	Unsigned8	0x01
BlockVersionLow	Unsigned8	0x01
API	Unsigned32	0x00000000
SlotNumber	Unsigned16	
SubslotNumber	Unsigned16	
ChannelNumber	Unsigned16	0x8000 = Whole submodule
ChannelProperties	Unsigned16	
<ChannelDiagnosis> or <ExtChannelDiagnosis>		

ChannelDiagnosis

Field	Size	Description
UserStructureIdentifier	Unsigned16	0x8000 = ChannelDiagnosis
ChannelDiagnosisData		
<Channel> ChannelNumber	Unsigned16	0x0000 – 0x7FFF: Manufacturer-specific 0x8000: Submodule (only one coding should be used for ChannelProperties.Direction.) 0x8001 – 0xFFFF: Reserved
<Channel> ChannelProperties	Unsigned16	See the "ChannelProperties" table below
<Channel> ChannelErrorType	Unsigned16	The error code for the MF device can be found in the chapter MF Devices (Page 53). The error code for I/O modules can be found in chapter "Diagnostics alarms" in the "Error code" column of the Equipment Manuals (https://support.industry.siemens.com/cs/ww/en/view/109742709).

ExtChannelDiagnosis

Field		Size	Description
UserStructureIdentifier		Unsigned16	0x8002 = ExtChannelDiagnosis
ExtChannelDiagnosisData			
<Channel>	ChannelNumber	Unsigned16	0x0000 – 0x7FFF: Manufacturer-specific 0x8000: Submodule (only one coding should be used for ChannelProperties.Direction.) 0x8001 – 0xFFFF: Reserved
<Channel>	ChannelProperties	Unsigned16	See the "ChannelProperties" table below
<Channel>	ChannelErrorType	Unsigned16	The error code for the MF device can be found in the chapter MF Devices.
<Channel>	ExtChannelErrorType	Unsigned16	
<Channel>	ExtChannelAddValue	Unsigned32	The error code for I/O modules can be found in chapter "Diagnostics alarms" in the "Error code" column of the Equipment Manuals.

ChannelProperties

Bits	Field	Description
0...7	ChannelProperties.Type	0x00: If ChannelNumber == 0x8000 0x01: The data length of the channel is 1 bit. 0x02: The data length of the channel is 2 bits. 0x03: The data length of the channel is 4 bits. 0x04: The data length of the channel is 8 bits. 0x05: The data length of the channel is 16 bits. 0x06: The data length of the channel is 32 bits. 0x07: The data length of the channel is 64 bits. 0x08 - 0xFF: Reserved
8	ChannelProperties.Accumulative	1 = Group diagnostics of more than one channel 0 = Other
9...10	ChannelProperties.Maintenance	0x00: Error 0x01: Maintenance required 0x02: Maintenance demanded 0x03: QualifiedChannelQualifier (indicates that the severity is coded in the field QualifiedChannelQualifier.)
11...12	ChannelProperties.Specifier	0x00: All following outgoing 0x01: Incoming 0x02: Outgoing 0x03: Outgoing, but other still present
13...15	ChannelProperties.Direction	0x00: Manufacturer-specific 0x01: Input 0x02: Output 0x03: Input/output 0x04 - 0x07: Reserved

6.4 Supported CIP objects for EtherNet/IP

6.4.1 Identity Object

The following information applies to the Identity Object.

Class code 0x01
Class attributes 1, 2, 3
Class services 0x01, 0x05, 0x0E
Instance attributes 1, 2, 3, 4, 5, 6, 7
Instance services 0x01, 0x05, 0x0E
Number of instances 1

Attributes of instance 1 for the Identity object

Attribute ID	Access rule	Designation	Data type	Data value
1	Retrieve	Vendor	UINT	0x04E3
2	Retrieve	Device type	UINT	0x000C
3	Retrieve	Product code	UINT	<ul style="list-style-type: none"> PN/MF Coupler: 0x0FA0 ET 200SP MF: 0x0FA2
4	Retrieve	Revision Major revision Minor revision	Structure of: USINT USINT	Depending on the firmware Vx.y.z <ul style="list-style-type: none"> Major = $x*10+y$ Minor = z
5	Retrieve	Status	WORD	Defined in the definition table below Device_Status
6	Retrieve	Serial number	UDINT	Last 4 bytes of the MAC address
7	Retrieve	Product label Character string length ASCII character string	Structure of: USINT STRING	<ul style="list-style-type: none"> PN/MF Coupler ET 200SP MF

Device_Status definitions for the Identity object

Bit(s)	Called	Definition	
0	Owned by	TRUE indicates that the device (or an object in the device) has an owner. 0 = No Exclusive Owner IO connection established 1 = At least one Exclusive Owner IO connection established	
1	-	Reserved	
2	Configured	TRUE indicates that the use of this device was configured so that it executes something other than the "Out-of-Box" standard. This does not include configuration of the communication. 0 = No valid MultiFieldbus project saved in the MF device (MF device in status < online) 1 = Active MultiFieldbus project saved in the MF device (MF device in status >= online) (Without a valid MF project with EtherNet/IP modules, the MultiFieldbus driver is offline and the CIP object cannot be accessed. This results in a timeout error.)	
3	-	Reserved	
4 to 7	Extended device status	Bits 4 to 7 Description of the extended device status	
		0 0 0 0	Self-test or unknown.
		0 0 0 1	Ongoing firmware update.
		0 0 1 0	At least one faulty I/O connection. <ul style="list-style-type: none"> I/O connection timed out? I/O module missing? I/O module IOxS bad?
		0 0 1 1	No I/O connections established.
		0 1 0 0	Non-volatile configuration faulty. <ul style="list-style-type: none"> Multi-fieldbus project damaged? ModuleDiffBlock?
		0 1 0 1	Severe error – either bit 10 or bit 11 is TRUE (1).
		0 1 1 0	At least one I/O connection is in RUN operating state.
		0 1 1 1	At least one I/O connection established, all in idle.
		1 0 0 0	Reserved
		1 0 0 1	Reserved
1 0 1 0 to 1 1 1 1	Manufacturer/product-specific.		
8	Minor, correctable error	TRUE indicates that the device has detected an internal problem which it considers to be correctable. The problem prevents the device from entering one of the faulty states. See the note below regarding the behavior.	
9	Minor uncorrectable error	TRUE indicates that the device has detected an internal problem which it considers to be uncorrectable. The problem prevents the device from entering one of the faulty states. See the note below regarding the behavior.	
10	Severe, correctable error	TRUE indicates that the device has detected an internal problem which has put the device in the "Severe, correctable error" state. See the note below regarding the behavior.	
11	Severe uncorrectable error	TRUE indicates that the device has detected an internal problem which has put the device in the "Severe, uncorrectable error" state. See the note below regarding the behavior.	
12 to 15	-	Reserved	

Note**Response after an error**

A device cannot communicate in the "Severe uncorrectable error" state. This means it might also not be able to signal a severe uncorrectable error. A reset service is not processed. The only option to remedy a severe, uncorrectable error is to turn the power supply off and then on again.

General services for the Identity object

Service code	Implemented for		Service designation
	Class	Instance	
0x01	Yes	Yes	Get_Attributes_All
0x05	Yes	Yes	Reset
0x0E	Yes	Yes	Get_Attribute_Single

6.4.2 Assembly Object

The following information applies to the Assembly object.

Class code 0x04
Class attributes 1, 2, 3
Class services 0x0E
Instance attributes 1, 2, 3
Instance services 0x0E, 0x10
Number of instances 4

Class attributes for the Assembly object

Attribute ID	Access rule	Description	Data type	Default value
1	Retrieve	Revision of this object	UINT	0x0002
2	Retrieve	Maximum permissible instance	UINT	0x0069
3	Retrieve	Number of instances	UINT	0x0004

Instance attributes for the Assembly object:**Instance 768 (0x300): Output Assembly/Connection Point**

Attribute ID	Access rule	Description	Data type	Default value
3	Set	Output data	ARRAY of BYTE	---

Instance 769 (0x301): Input Assembly/Connection Point

Attribute ID	Access rule	Description	Data type	Default value
3	Retrieve	Input data	ARRAY of BYTE	---

Instance 775 (0x307): Config Assembly/Connection Point

Attribute ID	Access rule	Description	Data type	Default value
3	Retrieve	Reserved for future use	ARRAY of BYTE	Zero

General services for the Assembly object

Service code	Available service		Service designation	Description
	Class	Instance		
0x0E	Yes	Yes	Get_Attribute_Single	Returns contents of all relevant attributes
0x10	No	Yes	Set_Attribute_Single	Changes an attribute value

6.4.3 Connection Manager Object

The following information applies to the Connection Manager object.

Class code	0x06
Class attributes	1, 2, 3
Class services	0x01, 0x0E
Instance attributes	1, 2, 3, 4, 5, 6, 7, 8
Instance services	0x01, 0x0E
Number of instances	1

Attributes of instance 1 for the Connection Manager object

Attribute ID	Required in case of implementation	Access rule	NV	Designation	Data type	Description
1	Optional	Set ¹	V	Open Requests	UINT	Number of received Forward Open service requests.
2	Optional	Set ¹	V	Open Format Rejects	UINT	Number of Forward Open service requests that were rejected due to an incorrect format.
3	Optional	Set ¹	V	Open Resource Rejects	UINT	Number of Forward Open service requests that were rejected due to insufficient resources.
4	Optional	Set ¹	V	Open Other Rejects	UINT	Number of Forward Open service requests that were not rejected due to an incorrect format or a lack of resources.
5	Optional	Set ¹	V	Close Requests	UINT	Number of received Forward Close service requests.
6	Optional	Set ¹	V	Close Format Requests	UINT	Number of Forward Close service requests that were rejected due to an incorrect format.
7	Optional	Set ¹	V	Close Other Requests	UINT	Number of Forward Close service requests that were not rejected due to an incorrect format.
8	Optional	Set ¹	V	Close Timeout	UINT	Total number of connection timeouts that occurred in connections controlled by this Connection Manager.

¹ A device can reject a Set request for this attribute with the General Status Code 0x09 (Invalid attribute value) if the sent attribute value is not zero.

General services for the Connection Manager object

Service code	Implemented for		Service designation
	Class	Instance	
0x01	Yes	Yes	Get_Attributes_All
0x0E	Yes	Yes	Set_Attribute_Single

6.4.4 TCP/IP Interface Object

The TCP/IP interface object offers you access to status information and configuration of the TCP/IP network interface.

Class code	0xF5
Class attributes	1, 2, 3
Class services	0x1, 0xE
Instance attributes	1, 2, 3, 4, 5, 6, 13
Instance services	0x1, 0xE, 0x10
Number of instances	1

Class attributes for the TCP/IP interface object

Attribute ID	Access rule	Description	Data type	Default value
1	Retrieve	Revision	UINT	0x0004
2	Retrieve	Maximum permitted number of instances	UINT	0x0001
3	Retrieve	Number of instances	UINT	0x0001

Instance attributes for the TCP/IP interface object

Attribute ID	Access rule	Description	Data type	Default value	Value semantics
1	Retrieve	Interface status (status)	DWORD	0x00000002	See table below: "Table for "interface status", attribute 1"
2	Retrieve	Interface capability bit memory (configurability)	DWORD	0x00000010	<p>Bit 0: BOOTP client (0 = No)</p> <p>Bit 1: DNS client (0 = No)</p> <p>Bit 2: DHCP client (0 = No)</p> <p>Bit 3: DHCP-DNS update (0 = Device cannot send its host name in the DHCP request)</p> <p>Bit 4: Configuration adjustable (1 = Interface control bit memory is adjustable, see attribute 3)</p> <p>Bit 5: Configurable hardware: 0 = IP address of the component of the attribute of the interface configuration cannot be called over the hardware settings (e.g. setting wheel, etc.)</p> <p>Bit 6: A change of the interface configuration requires a reset (false): 1 = A restart of the device is required for the change of the attribute of the interface configuration to take effect. 0 = the change of the attribute of the interface configuration takes effect immediately.</p> <p>Bit 7: AcdCapable: 0 = The device is not ACD-capable</p> <p>Bit 8...31: Reserved</p>
3	Retrieve	Interface control bit memory (configuration control)	DWORD	0x00000000	<p>Bit 0 to 3: Starting configuration (0 = As saved in flash memory, 1 = Via BOOTP, 2 = Via DHCP, 3 to 15 = Reserved)</p> <p>Bit 4: Enable DNS (False)</p>
4	Retrieve	Path to the physical link object	STRUCT from:		Identifies the object that is associated with the underlying physical communication object.
		Path size	UINT	0x0002	Number of 16-bit words in the path.
		Logical segments that identify the physical link	Increased EPATH	Class: = 0xF6 Instance = 1	Path address of the internal port of the embedded switch.
5	Retrieve	TCP/IP network interface configuration	STRUCT from:		Contains parameters that are required for operation as TCP/IP node. To prevent an incomplete or incompatible configuration, the parameters cannot be set individually. Users must first "retrieve" this attribute, change the desired parameters, and then "set" the attribute.

6.4 Supported CIP objects for EtherNet/IP

Attribute ID	Access rule	Description	Data type	Default value	Value semantics
		IP address	UDINT	IP address of the device	The value 0 indicates that no IP address was configured. Otherwise, a valid address of class A, B or C must be set but not the loopback address (127.0.0.1).
		Network mask	UDINT	Network mask of the device	The value 0 indicates that no network mask address was configured.
		Gateway address	UDINT	Standard gateway address	The value 0 indicates that no IP address was configured. Otherwise, a valid address of class A, B or C must be set but not the loopback address (127.0.0.1).
		Primary name server	UDINT	0x00000000	The value 0 indicates that no name server address was configured. Otherwise, a valid A, B or C address must be set.
		Secondary name server	UDINT	0x00000000	The value 0 indicates that no secondary name server address was configured. Otherwise, a valid A, B or C address must be set.
		Domain name	STRING	0x0000 (length = 0, empty CHARACTER STRING)	ASCII characters. Maximum permissible length is 48 characters. Must be increased to an even number of characters (increase is not included in length). The length 0 indicates that no domain name is configured.
6	Set	Host name	STRING	Not supported (length zero)	ASCII characters. The maximum permissible length is 64 characters. Increased to an even number of characters (increase is not included in length). The length 0 indicates that no host name is configured.
13	Set	Encapsulation idle time	UINT	120	0 = disabled 1 to 3600 = timeout in seconds

Table for "Interface status", attribute 1

Bit(s):	Called:	Definition
0 to 3	Interface configuration status	<p>Displays the status of the interface configuration attribute.</p> <p>0 = The interface configuration attribute was not configured 1 = The interface configuration attribute contains a valid configuration obtained from BOOTP, DHCP or non-volatile memory. 2 = The interface configuration attribute contains a valid configuration obtained from hardware settings (e.g. push wheel, thumbwheel, etc.) 3 to 15 = Reserved for future use</p>
4	Mcast requested	Specifies a requested configuration change in the TTL value and/or in the McastConfig attributes. This bit is set when either the TTL value or the McastConfig attribute is set and deleted later as soon as the device starts.
5	Interface Configuration Pending	Shows a pending configuration change in the Configuration-Attribute interface. The bit turns 1 (TRUE) when the Configuration-Attribute interface is set; the device needs a reset for the configuration change to become effective (as shown in the Configuration-Attribute interface). The reason for the Interface Config Pending bit is to permit the client software to know that the IP configuration has changed but only becomes active after a device reset.
6	AcdStatus	Indicates that an IP address conflict was detected by ACD. The bit is set to 0 (FALSE) by default during startup. When ACD is supported and activated, the bit is set to 1 (TRUE) whenever an address conflict as defined in [ConflictDetected] transition in Figure F-1.1 ACD Behavior of Volume 2 EtherNet/IP Adaptation of CIP, Appendix was detected.
7	AcdFault	Indicates that an IP address conflict was detected by ACD or the defense failed, and the current interface configuration can not be used due to a conflict. The bit turns 1 (TRUE) if an address conflict was detected and the interface is in the ACD status Notification & FaultAction or AcquireNewIpv4Parameters, as defined in Annex F. In other cases, the bit turns 0 (FALSE). Note that if the bit is set, the CIP port can not be used. However, the bit offers a way for devices with several ports to find out whether the port has an ACD error and therefore can not be used.
8	IANA Port Admin Change Pending	Shows a pending configuration change in the IANA Port Admin attribute. The bit is set when the device needs a reset for the configuration change to become effective (as shown in the Admin Capability element of the IANA Port Admin attribute).
9	IANA Protocol Admin Change Pending	Shows a pending configuration change in the IANA Protocol Admin attribute. The bit is set when the device needs a reset for the configuration change to become effective (as shown in the Admin Capability element of the IANA Protocol Admin attribute).
10 to 31	Reserved	Reserved for future use and set to zero.

General services for the TCP/IP interface object

Service code	Available service		Service designation	Description
	Class	Instance		
0x01	Yes	Yes	Get_Attribute_All	Returns contents of all attributes
0x0E	Yes	Yes	Get_Attribute_Single	Returns contents of all relevant attributes
0x10	No	Yes	Set_Attribute_Single	Changes an attribute value

6.4.5 EtherNet Link Object

The EtherNet Link object saves link-specific counters and status information for a IEEE 802.3 communication interface. MF devices have an embedded two-port switch and an instance of the EtherNet Link object for the internally accessible interface.

Values set in instance 1 attribute 6 are valid for both ports.

Class code -
Class attributes 1, 2, 3
Class services 0x1, 0xE, 0x10
Instance attributes 1, 2, 3, 4, 5, 6, 7, 8, 10, 11
Instance services 0x1, 0xE, 0x10
Number of instances 2

Class attributes for the EtherNet Link object

Attribute ID	Access rule	Designation	Description	Data type	Value semantics
1	Retrieve	Revision	Revision of this object	UINT	1 = The minimum value ≥ 2 = When the instance attribute 6 is implemented 3 = The maximum value
2	Retrieve	Max. instance	Maximum instance number of an object that was currently created on this class level of the device.	UINT	The greatest instance number of a created object on this class hierarchy level.
3	Retrieve	Number of instances	Number of object instances that were currently created on this class level of the device.	UINT	The number of object instances on this class hierarchy level.

Attributes of instance 1 for the EtherNet Link object

Attribute ID	Access rule	Designation	Description	Data type	Value semantics
1	Retrieve	Interface speed	Currently applied interface speed	UDINT	Speed in Mbps (10, 100, etc.). Default = 100
2	Retrieve	Interface bit memory	Interface status bit memory	DWORD	Bitmap of interface bit memory. See table below, "Interface bit memory attribute".
3	Retrieve	Physical address	MAC layer address	ARRAY of 6 USINTs	MAC layer address in the format "XX-XX-XX-XX-XX-XX."
4	Retrieve	Interface counter	Important for receiving packets	STRUCT from:	See section "Interface counter" below.
5	Retrieve	Media counter	Media-specific counters	STRUCT from:	See "Media counter" section below.
6	Set	Interface control	Configuration for physical interface	STRUCT from:	See the following section, "Interface control".
		Control bits	Interface control bits	WORD	See the following section, "Interface control"

6.4 Supported CIP objects for EtherNet/IP

Attribute ID	Access rule	Designation	Description	Data type	Value semantics
		Forced interface speed	Speed at which the interface is supposed to work	UINT	Speed in Mbps (10, 100, etc.). When the autonegotiation bit is 0, the forced interface speed bits show the speed at which the interface is to operate.
7	Retrieve	Interface type	Interface type: Twisted pair, fiber, internal, etc.	USINT	2 = Twisted pair 3 = Optical fiber
8	Retrieve	Interface status	Current status of the interface: in operation, disabled, etc.	USINT	0 = Unknown 1 = Enabled and ready for sending (default) 2 = Disabled 3 = Testing
10	Retrieve	Interface name	Human-readable identifier	SHORT_STRING	"Siemens, SIMATIC S7, Ethernet Port, X1 P1 R" "Siemens, SIMATIC S7, Ethernet Port, X1 P2 R"
11	Retrieve	Interface capability	Shows the capabilities of the interface	STRUCT from:	----
		Function bits	Interface capabilities except speed/duplex	DWORD	Bitmap
		Speed/duplex options	Shows speed/duplex pairs supported by the interface control attribute	STRUCT from:	----
			Speed/duplex array counter	USINT	Number of elements
			Speed/duplex array	ARRAY of STRUCT from:	----
			Interface speed	USINT	The semantics are the same as for the forced interface speed in the interface control attribute: Speed in Mbps.
			Interface duplex mode	USINT	0 = Half-duplex 1 = Full duplex 2 to 255 = Reserved

Interface bit memory attribute

Bit(s):	Called:	Definition
0	Link status	Specifies whether the IEEE 802.3 communication interface is connected to an active network: 0 = Inactive link. 1 = Active link. Specification of the link status depends on the implementation.
1	Half duplex / full duplex	Indicates the currently used duplex mode: 0 = Interface runs at half duplex. 1 = Interface runs at full duplex. Note that the value of the half duplex / full duplex is undefined when the link status bit memory is 0.
2 to 4	Negotiation status	Specifies the status of the link autonegotiation: 0 = Ongoing autonegotiation. 1 = Autonegotiation and speed measurement failed. Use of default values for speed and duplex. 2 = Autonegotiation failed, but speed was measured. Duplex was faulty. 3 = Speed and duplex negotiated successfully. 4 = Autonegotiation not attempted. Forced speed and duplex.
5	Manual setting requires re-set.	0 = Interface can automatically activate changes to link parameters (autonegotiate, duplex mode, interface speed). 1 = Device requires that a reset service is output at its Identity object so that the changes will become effective.
6	Local hardware fault	0 = Interface does not detect a local hardware fault. 1 = Local hardware fault detected.
7 to 31	Reserved	Set to 0.

Interface counter (STRUCT from):

Designation	Data type	Attribute description
In Octets	UDINT	Octets received at the interface
In Ucast Packets	UDINT	Unicast packets received at the interface
In NUcast Packets	UDINT	Non-Unicast packets received at the interface
In Discards	UDINT	Incoming packets received at interface but discarded
In Errors	UDINT	Incoming packets containing errors (excluded In Discards)
In Unknown Protos	UDINT	Incoming packets with unknown protocol
Out Octets	UDINT	Octets transmitted by the interface
Out Ucast Packets	UDINT	Unicast packets transmitted by the interface
Out NUcast Packets	UDINT	Non-Unicast packets transmitted by the interface
Out Discards	UDINT	Outgoing packets discarded
Out Errors	UDINT	Outgoing packets containing errors

Media counter (STRUCT from):

Designation	Data type	Attribute description
Alignment Errors	UDINT	Frames received that not only include complete octets
FCS Errors	UDINT	Frames received that do not pass the FCS test
Single Collisions	UDINT	Successfully transmitted frames with exactly one collision
Multiple Collisions	UDINT	Successfully transmitted frames with more than one collision
SQE Test Errors	UDINT	Number of error messages generated by SQE test
Deferred Transmission	UDINT	Frames whose transmission is delayed due to medium overload
Late Collisions	UDINT	Number of cases in which a collision is detected later than after transmission of 512 bits of the packet
Excessive Collisions	UDINT	Frames whose transmission fails due to a very high number of collisions
MAC transmission error	UDINT	Frames whose transmission failed due to an internal transmission error in the MAC sublayer
Carrier Sense Errors	UDINT	Number of carrier tests that failed or were not executed during transmission of a frame
Frame Too Long	UDINT	Frames received that exceed the permissible maximum size
MAC receive error	UDINT	Frames whose receipt at an interface failed due to an internal transmission error in the MAC sublayer

Interface control attribute

The interface control attribute is a structure that consists of bits of the forced interface speed and control bits.

When the autonegotiate bit is 0, the bit of the forced interface speed specifies the speed at which the interface is operating. The speed is given in megabits per second; the interface speed for an Ethernet with 10 Mbps, for example. Interfaces that do not support the required speed, show 0x09 (invalid attribute value). When autonegotiation is enabled, the attempt to set the forced interface speed results in the response 0x0C (object status conflict).

Control bits work as follows:

Bit(s)	Called:	Definition
0	Autonegotiate	0 = 802.3 Link autonegotiation is disabled. 1 = Autonegotiation is enabled. When autonegotiation is disabled, the device uses the settings made by the bits of the forced duplex mode and the forced interface speed.
1	Forced duplex mode	When the autonegotiate bit is 0, the bit of the forced duplex mode specifies whether the interface operates in full duplex or half duplex mode. 0 = Half-duplex 1 = Full duplex Interfaces that do not support the required duplex mode, show 0x09 (invalid attribute value). When autonegotiation is enabled, the attempt to set the bits of the forced duplex mode results in the response 0x0C (object status conflict).

Interface capability

The interface capability attribute displays the number of interface capabilities. The attribute is a structure with two main elements: Function bits and speed/duplex options

Bit(s)	Called:	Definition
0	Manual setting requires reset	Indicates whether a device requires a reset to apply changes of the interface control attribute (#6). 0 = Indicates that changes made to the interface control attribute (#6) will become effective without resetting the device. The bit takes on this value when the interface control attribute (#6) is not implemented. 1 = Indicates that changes made to the interface control attribute (#6) are not applied automatically but will only become effective by resetting the device. Note: This bit is repeated in the interface bit memory attribute (#2) to ensure backward compatibility with earlier object revisions.
1	Autonegotiate	0 = Indicates that the interface does not support link autonegotiation. 1 = Indicates that the interface supports link autonegotiation.
2	Auto-MDIX	0 = Indicates that the interface does not support automatic MDIX mode. 1 = Indicates that the interface supports MDIX mode.
3	Speed/duplex manual	0 = Indicates that the interface does not support manual setting of speed/duplex. The interface control attribute (#6) is not supported. 1 = Indicates that the interface supports manual setting of speed/duplex via the interface control attribute (#6).
4 to 31	Reserved	Set to 0

General services for the EtherNet Link object

Service code	Required in implementation		Service designation	Description
	Class	Instance		
0x01	Optional	Optional	Get_Attribute_All	Returns contents of all attributes.
0x0E	Conditional	Required	Get_Attribute_Single	Returns contents of all relevant attributes.
0x10	Not applicable	Conditional	Set_Attribute_Single	Changes a single attribute.

6.4.6 LLDP Management Object

The object contains management information for LLDP and should be present if LLDP is implemented on the device. Only one instance of the LLDP management object should be implemented.

Referring to ODVA Specification Rel.1911 / Volume 2 (1.25) / 5-15 LLDP Management Object.

Class code 0x109
 Instance attributes 1, 2, 3, 4, 5
 Number of instances 1

Attributes of instance 1 for the LLDP Management Object

Attribute ID	Access rule	Designation	Description	Data type	Value semantics
1	Setting required	LLDP Enable		STRUCT from:	
		LLDP Enable Array Length	The number of elements in the LLDP Enable Array. Matches the Max Ethernet Link Object Instance Number. This value, divided by 8 and the remainder rounded, specifies the length (in bytes) of the LLDP Enable Array of this structure.	UINT	Class attribute 2 of the Ethernet Link Object (0xF6)
		LLDP Enable Array	Enables the generation of LLDP frames globally or per port and the processing of received LLDP frames globally.	ARRAY from BOOL	Bit number: 0: Enable globally 1-N: Corresponds to the instance number of each port of Ethernet Link Max Instance, N = value of Ethernet Link Max Instance class attribute 2 For every bit: 0 = LLDP deactivated, 1 = LLDP activated (default) If Enable globally (bit 0) = 0, then the other bits must be ignored and the received LLDP frames are ignored. The values of the elements corresponding to non-existing Ethernet link instances must be set to 0 or are ignored.

Attribute ID	Access rule	Designation	Description	Data type	Value semantics
2	Setting required	msgTxInterval	From 802.1AB-2016. The interval in seconds after which the LLDP frames were sent from the device	UINT	0-4 = Reserved, 5-32768 = Message Transmission Interval for LLDP frames, 32769-65535 = Reserved Recommended default setting is 30. Default value = 5 (Only acceptable value to be additionally compliant with the PNIO standard.).
3	Retrieval required	msgTxHold	From 802.1AB-2016. A factor of msgTxInterval to determine the value of TTL TLV that was sent by the neighboring device	USINT	0 = Reserved, 1-100 = Message Transmission Multiplier for LLDP frames, 101-255 = Reserved Recommended default setting is 4.
4	Retrieval required	LLDP Datastore	An indication of the query method that is supported by the service's LLDP database (see Section 9-8.5)	WORD	Bit: 0 = LLDP Data Table Object (Default) 1 = SNMP 2 = NETCONF YANG 3 = RESTCONF YANG 4-15 = Reserved
5	Retrieval required	Last Change	The number of seconds since the last time an entry in the local LLDP database (without TTL) has changed.	UDINT	Seconds since last change

6.4.7 LLDP Data Table Object

The object contains information about received LLDP frames and should be present if LLDP is implemented on the device and SNMP LLDP MIB has not been implemented.

Referring to ODVA Specification Rel.1911 / Volume 2 (1.25) / 5-16 LLDP Data Table Object.

Class code 0x10A
Class attributes 2, 3
Instance attributes 1, 2, 3, 4, 5, 6, 7, 8, 9
Number of instances 2

Attributes for the LLDP Data Table Object

Attribute ID	Access rule	Designation	Description	Data type	Value semantics
1	Retrieval required	Ethernet Link Instance Number	The local instance number of the Ethernet Link Object that corresponds to the physical Ethernet port of the received instance that makes up the LLDP frame, if available.	UINT	0 = Unknown 1-65535 = Ethernet Link Object (0xF6) instance number
2	Retrieval required	MAC address	The neighboring MAC address received from the CIP MAC address, Chassis ID, or Port ID TLV.	ETH_MAC_ADDR	The MAC address is set with the first occurrence of a MAC ID in the following list: 1. The CIP MAC address (TLV type = 127, subtype = 2) 2. The Chassis ID (TLV type = 1) only if subtype = 2 3. The Port ID (TLV Type = 2) only if subtype = 3 4. All zero
3	Retrieval required	Interface Label	The neighboring Interface Label received from the CIP Interface Label, Chassis ID, or Port ID TLV	Short_String	The Interface Label will be a maximum of 64 characters long. It is set with the first occurrence of an Interface Label which is contained in the following list: 1. The CIP Interface Label (TLV type = 127, subtype = 1) 2. The Chassis ID (TLV type = 1) only if subtype = 6 3. The Port ID (TLV type = 2) only if subtype = 5 4. One zero string
4	Retrieval required	Time to Live	Number of seconds for which the neighborhood information is considered valid.	UINT	(TLV type = 3) 0 = Reserved, 1-65535 = Time To Live (in seconds) Note: A received TTL TLV value = 0 means that the table entry should be removed according to IEEE 802.1AB-2016.
5	Retrieval required	System Capabilities TLV		STRUCT from:	(TLV type = 7) See section 5-16.3.3.1
		System Capabilities	The capabilities that the neighboring device supports based on the currently loaded firmware.	WORD	
		Enabled Capabilities	The capabilities currently activated on the neighboring device.	WORD	

6.4 Supported CIP objects for EtherNet/IP

Attribute ID	Access rule	Designation	Description	Data type	Value semantics
6	Retrieval required	IPv4 Management Addresses	The IPv4 management addresses of the neighboring device.	Struct from:	A list of IPv4-encoded management addresses, as defined by one or more received management addresses TLVs (TLV type = 8). Without non-IPv4 management addresses
		Management Address Count	Number of implemented management addresses	USINT	0-255 = Number of received Management Address TLVs from its neighbor.
		Management Address	IPv4 management addresses of neighboring devices	ARRAY from UDINT	The IP address must be assigned a valid Class A, B or C address and must not consist of just zeros or be the loopback address (127.0.0.1).
7	Retrieval required	CIP Identification	The CIP Identification TLV of the neighboring device, if available.	STRUCT from:	Set by CIP Identification TLV (TLV type = 127, subtype = 01), if available, otherwise 0.
		Vendor ID		UINT	See Volume 1, Appendix C-1.4.2, format 5 for details and semantics
		Device Type		UINT	
		Product Code		UINT	
		Major Revision		BYTE	
		Minor Revision		UINT	
	CIP Serial Number		UDINT		
8	Retrieval required	Additional Ethernet Capabilities	A TLV for Ethernet pre-emption support from the neighboring device	STRUCT from:	Set by Additional Ethernet Capabilities TLV (TLV type = 127, subtype 7), if available, otherwise 0 See IEEE 802.3-2018 79.3 for more information.
		Preemption Support		BOOL	0 = Not supported 1 = Supported
		Preemption Status		BOOL	0 = Not released 1 = Released
		Preemption Active		BOOL	0 = Not active 1 = Active
		Additional Fragment Size		USINT	0 = 64 octets 1 = 128 octets 2 = 192 octets 3 = 256 octets 4-255 = Reserved
9	Retrieval required	Last Change	The number of seconds since the last time an attribute in this instance has changed.	UDINT	Seconds since last change

6.4.8 Param Object

The following information applies to the Param Object of the MF device.

Class code	0x66
Class attributes	1
Class services	-
Instance attributes	-
Instance services	-
Number of instances	256

Class attributes for the Param Object

Attribute ID	Access rule	Description	Data type	Default value
1	Retrieve	Revision of this object	UINT32	

Attributes of instance 1 for the Param Object

Attribute ID	Access rule	Designation	Data type	Data value
<Recln- dex>	ReadRecord (0x32)	ParamArray	Array of UINT8	Call: ReadRequestData[0..3] = Length of the requested data record to be read. (Big Endian) Answer: ReadResponseData[0..3] = <i>ReadLength</i> of the returned data of the data record ReadResponseData[4.. <i>ReadLength</i> +3] = read data record as array from bytes
	WriteRecord (0x33)	ParamArray	Array of UINT8	Call: WriteRequestData[0..3] = <i>WriteLength</i> of data of the data record (Big Endian) WriteRequestData[4.. <i>WriteLength</i> +3] = data of the data record to be written as array from bytes Answer: No user data returned.

Answer-Record-Mapping

PROFINET ErrorCode1		EtherNet/IP CIP Status	
Success:			
0x00	Successful Operation	0x00	Success
Application error:			
0xA0	Read Error	0x1F	Vendor specific error
0xA1	Write Error	0x1F	Vendor specific error
0xA2	Module Failure	0x1F	Vendor specific error
0xA7	Busy	0x1E	Embedded service error
0xA8	Version Conflict	0x1F	Vendor specific error
0xA9	Feature Not Supported	0x14	Attribute not supported
Access error:			
0xB0	Invalid Index	0x09	Invalid attribute value
0xB1	Write Length Error	0x15	Too much data
0xB2	Invalid Slot/Subslot	0x05	Class/Instance unknown
0xB3	Type Conflict	0x0E	Attribute not settable
0xB4	Invalid Area/API	0x16	Object does not exist
0xB5	State Conflict	0x10	Device state conflict
0xB6	Access Denied	0x0F	Privilege violation
0xB7	Invalid Range	0x20	Invalid parameter
0xB8	Invalid Parameter	0x20	Invalid parameter
0xB9	Invalid Type	0x29	Member not settable
Resources error:			
0xC0	Read Constrain Conflict	0x2C	Attribute not gettable
0xC1	Write Constrain Conflict	0x0E	Attribute not settable
0xC2	Resource Busy	0x0C	Object state conflict
0xC3	Resource Unavailable	0x02	Resource unavailable
S7+ module application error:			
0xE0	Invalid Record Struct	0x24	Message Format Error
0xE1	Invalid User Param	0x03	Invalid parameter value
ELSE response error:			
		0x1F	Vendor specific error

When not enough data is provided for the Record Message Source Element, the device always returns CIP Status error 0x06 (Partial Transfer).

Operation and maintenance

You update the firmware of the PN/MF Coupler via PROFINET IO: In SIMATIC Manager using **PLC > Show accessible devices**

To update the firmware, you will need files (*.UPD) containing the current firmware.

You can find the latest firmware on the Internet (<https://support.industry.siemens.com/cs/de/de/ps/6ES7-3AD10-0XA0/dl>).

7.1 Updating firmware via PROFINET IO

Updating firmware via PROFINET IO

You update the firmware using one of the two PROFINET IO interfaces.

Requirements:

- The PN/MF Coupler must be accessible online for the firmware update.
- The files with the current firmware version must be available in the file system of your programming device or PC.

Note

Firmware activated after download

If you have selected the "Activate firmware after download" option for the firmware update via PROFINET IO, both sides of the coupler will interrupt the data transfer temporarily when the firmware is activated.

Further information

The STEP 7 online help system provides information on how to proceed.

7.2 Replacing a defective PN/MF Coupler

Introduction

For a new PN/MF Coupler, the R/W objects (I&M, SNMP and parameter assignment data) in the PN/MF Coupler are set to factory settings.

Replacement part case

You must bring a previously used PN/MF Coupler to the "Reset to factory settings" state before using it as a replacement part.

Procedure

To replace a defective PN/MF Coupler, follow these steps:

1. De-energize the PN/MF Coupler.
2. Unscrew the BusAdapter.
3. Remove the BusAdapter from the PROFINET IO interfaces of the defective PN/MF Coupler.
4. Remove the power supply of the defective PN/MF Coupler.
5. Replace the defective PN/MF Coupler.
6. Plug the BusAdapters onto the PROFINET IO interfaces of the new PN/MF Coupler and screw them in place.
7. Connect the power supply connection to the new PN/MF Coupler.
8. Switch on the voltage again.

7.3 Reset to factory settings

Requirement

The supply voltage on the PN/MF Coupler is switched on.

Required tools

3 to 3.5 mm screwdriver (for resetting with a RESET button)

Procedure using the RESET button

To reset the PN/MF Coupler to factory settings using the RESET button, follow these steps:

1. Remove the PN/MF Coupler from the mounting rail, see Removing the PN/MF Coupler (Page 23), and swing it downwards.

Note

Power supply must be supplied with voltage

Both power supply connections must be supplied with voltage.

2. The RESET button is located on the rear of the PN/MF Coupler behind a small opening: Press a screwdriver into the small opening for at least 3 seconds to activate the RESET button.

Note

One RESET button but two power supplies

When the RESET button is pressed, the power supply must be supplied on this side of the PN/MF Coupler.

This means that if the left side of the PN/MF Coupler is to be reset, only the left power supply must be supplied with voltage and vice versa.

3. Mount the PN/MF Coupler again on the mounting rail, see Installing the PN/MF Coupler (Page 22).
4. Reassign the PN/MF Coupler parameters.

For additional information on retentively stored data, refer to the PROFINET Function Manual (<https://support.industry.siemens.com/cs/ww/en/view/49948856>).

Procedure using STEP 7 TIA Portal

To restore the factory settings for the PN/MF Coupler using STEP 7 TIA Portal, follow these steps:

Ensure there is an online connection to the PN/MF Coupler.

1. Open the list of accessible devices of your PG/PC interface.
2. In the "Functions" folder of any network side of the PN/MF Coupler, select "Reset to factory settings".
3. If you want to keep the I&M data, select the "Retain I&M data" option button. If you want to delete the I&M data, select the "Delete I&M data" option button.
4. Click the "Reset" button.
5. Click "Yes" in response to the confirmation prompt for the process.

Result: The PN/MF Coupler then performs a "Reset to factory settings" for both network sides. All data of the PN/MF Coupler is reset to factory settings. Firmware updates are retained. The included data of the BusAdapters are also deleted.

7.4 Maintenance and repair

The PN/MF Coupler is maintenance-free.

Note

Repairs to the PN/MF Coupler may only be carried out by the manufacturer.

Technical specifications

8.1 General technical specifications

8.1.1 Introduction

Scope of general technical specifications

The general technical specifications include:

- The standards and test values that are complied with and met by the described components.
- The test criteria based on which the described components were tested.

8.1.2 Standards and approvals

Currently valid markings and approvals

Note**Information on the housing of the PN/MF Coupler**

The currently valid markings and approvals are printed on the housing of the PN/MF Coupler.

Safety instructions

 WARNING
Pulling or plugging a module is prohibited in the hazardous area.
When you pull or plug a module or connector during operation, there is a risk of sparking. Sparks can cause an explosion in the hazardous area, death or serious physical injury as well as damage to property can result.
Do not pull or plug the module or the connectors until one of the following two conditions is met: The area is no longer hazardous or the device and its connectors are de-energized.

 WARNING
Explosion hazard
If you replace components, compliance with Class I, Div. 2 or zone 2 may become invalid.

 WARNING
Area of application
This device is only suitable for use in Class I, Div. 2, Group A, B, C, D; Class I, zone 2, Group IIC, or in non-hazardous areas.

Safety of the plant or the system

NOTICE
Safety is the responsibility of the assembler
The safety of any plant or system incorporating the equipment is the responsibility of the assembler of the plant or system.

5 safety rules for working in and on electrical installations

A set of rules, which are summarized in DIN VDE 0105 as the "five safety rules", are defined for work in or on electrical installations as a preventative measure against electrical accidents:

1. De-energize
2. Secure to prevent reconnection
3. Verify safe isolation from the supply
4. Connect to ground and short-circuit
5. Cover or provide barriers from adjacent live parts

These five safety rules must be applied in the above-indicated order before starting work on electrical equipment. After completing the work, proceed in the reverse order.

It is assumed that every electrician is familiar with these rules.

8.1 General technical specifications

CE approval



The PN/MF Coupler meets the requirements and protection targets of the following EU Directives and complies with the harmonized European standards (EN) for programmable logic controllers published in the official gazettes of the European Community:

- 2014/30/EU "Electromagnetic Compatibility" (EMC Directive)
- 2014/34/EU "Equipment and protective systems intended for use in potentially explosive atmospheres" (Explosion Protection Directive)
- 2011/65/EU "Restriction of the use of certain hazardous substances in electrical and electronic devices" (RoHS Directives).

The EU Declarations of Conformity are available for the authorities in charge and are kept at the following address:

Siemens AG
Digital Industries

Factory Automation
DI FA AS SYS
Postfach 1963
D-92209 Amberg

They are also available for download on the Siemens Industry Online Support website, under the keyword "Declaration of Conformity".

cULus approval



Underwriters Laboratories Inc. according to

- UL 61010-1
- UL 61010-2-201
- CAN/CSA C22.2 No. 61010-1
- CAN/CSA C22.2 No. 61010-2-201

OR

cULus HAZ. LOC. approval



Underwriters Laboratories Inc. according to

- UL 61010-1
- UL 61010-2-201
- CAN/CSA C22.2 No. 61010-1
- CAN/CSA C22.2 No. 61010-201
- ANSI/ISA 12.12.01
- CAN/CSA C22.2 No. 213 (Hazardous Location)

APPROVED for use in
Class I, Division 2, Group A, B, C, D Tx;
Class I, Zone 2, Group IIC Tx

Installation Instructions for cULus haz.loc.

- WARNING - Explosion Hazard - Do not disconnect while circuit is live unless area is known to be non-hazardous.
- WARNING - Explosion Hazard - Substitution of components may impair suitability for Class I, Division 2 or Zone 2.
- This equipment is suitable for use in Class I, Division 2, Groups A, B, C, D; Class I, Zone 2, Group IIC; or non-hazardous locations.

WARNING: EXPOSURE TO SOME CHEMICALS MAY DEGRADE THE SEALING PROPERTIES OF MATERIALS USED IN THE RELAYS.

OR

FM approval



Factory Mutual Research (FM) according to

- Approval Standard Class Number 3611, 3600, 3810
- ANSI/UL 121201
- ANSI/UL 61010-1
- CAN/CSA C22-2 No. 213
- CAN/CSA C22.2 No. 0-10
- CAN/CSA C22.2 No. 61010-1

APPROVED for use in Class I, Division 2, Group A, B, C, D Tx;
Class I, Zone 2, Group IIC Tx

Installation Instructions for FM

- WARNING - Explosion Hazard - Do not disconnect while circuit is live unless area is known to be non-hazardous.
- WARNING - Explosion Hazard - Substitution of components may impair suitability for Class I, Division 2 or Zone 2.
- This equipment is suitable for use in Class I, Division 2, Groups A, B, C, D; Class I, Zone 2, Group IIC; or non-hazardous locations.

WARNING: EXPOSURE TO SOME CHEMICALS MAY DEGRADE THE SEALING PROPERTIES OF MATERIALS USED IN THE RELAYS.

OR

ATEX approval



According to EN 60079-7 (Electrical apparatus for potentially explosive atmospheres - Part 7: Increased safety "e") and EN IEC 60079-0 (Electrical apparatus for potentially explosive gas atmospheres - Part 0: General requirements).

II 3 G Ex ec IIC Tx Gc
DEKRA 20ATEX0002 X

Special conditions in hazardous area:

1. The devices may only be used in a range not exceeding pollution degree 2, as defined in EN 60664-1.
2. The modules must be installed in a suitable enclosure that guarantees at least IP54 degree of protection according to EN 60079-7, taking into account the ambient conditions during use.
3. Measures must be taken to prevent the rated voltage from being exceeded by transient disturbance voltages of more than 119 V.

OR

IECEx approval



According to IEC 60079-7 (Explosive atmospheres - Part 7: Equipment protection by increase safety "e") and IEC 60079-0 (Explosive atmospheres - Part 0: Equipment - General requirements).

II 3 G Ex ec IIC Tx Gc
IECEx DEK 19.0086X

Special conditions in hazardous area:

1. The devices may only be used in a range not exceeding pollution degree 2, as defined in IEC 60664-1.
2. The modules must be installed in a suitable enclosure that guarantees at least IP54 degree of protection according to IEC 60079-7, taking into account the ambient conditions during use.
3. Measures must be taken to prevent the rated voltage from being exceeded by transient disturbance voltages of more than 119 V.

RCM (C-Tick) Declaration of conformity for Australia/New Zealand



The ET 200SP distributed I/O system fulfills the requirements of the standards

- EN 61000-6-4.

Korea Certification



KC registration number: KCC-REM-S49-DPPA

Please note that this device corresponds to limit value class A in terms of the emission of radio frequency interference. This device can be used in all areas, except residential areas.

이 기기는 업무용(A급) 전자파 적합기기로서 판매자 또는 사용자는 이 점을 주의하시기 바라며 가정 외의 지역에서 사용하는 것을 목적으로 합니다.

Marking for the Eurasian Customs Union



EAC (Eurasian Conformity)

Customs Union of Russia, Belarus and Kazakhstan

Declaration of conformity with the technical requirements of the Customs Union (TR CU).

8.1 General technical specifications

IEC 61131

The described components meet the requirements and criteria of IEC 61131-2 standard (Programmable logic controls, part 2: Equipment requirements and tests).

IEC 61010-2-201

The PN/MF Coupler fulfills the requirements and criteria of standard IEC 61010-2-201.

(Safety regulations for electrical equipment for measurement, control, and laboratory use Part 2-201: Particular requirements for control equipment).

Marine approval

The following marine approvals are planned for the PN/MF Coupler:

Classification organizations:

- ABS (American Bureau of Shipping)
- BV (Bureau Veritas)
- DNV-GL (Det Norske Veritas-Germanischer Lloyd)
- KR (Korean Register of Shipping) and CCS (China Classification Society)
- LRS (Lloyds Register of Shipping)
- Class NK (Nippon Kaiji Kyokai)

WEEE mark (European Union)



Disposal information, observe the local regulations.

PROFINET standard

The described components are based on the IEC 61158-6-10 standard.

Use in industrial environments

The PN/MF Coupler is designed for use in industrial environments. It meets the following standards for this type of use:

- Requirements on interference emission EN 61000-6-4: 2011
- Requirements on immunity EN 61000-6-2: 2005

Use in mixed areas

Under specific conditions, you can use the PN/MF Coupler in a mixed area. A mixed area is used for residential purposes and for commercial operations that do not significantly impact the residential purpose.

If you want to use the PN/MF Coupler in mixed areas, you must ensure that its radio frequency interference emission complies with limit class B in accordance with EN 61000-6-3. Suitable measures for observing these limits for use in a mixed area are, for example:

- Installation of the PN/MF Coupler in grounded control cabinets
- Use of filters in supply lines

An additional individual acceptance test is also required.

Use in residential areas

Note

PN/MF Coupler not intended for use in residential areas

The PN/MF Coupler is not intended for use in residential areas. If you are using the PN/MF Coupler in residential areas, radio and TV reception may be affected.

Reference

The certificates for the markings and approvals can be found on the Internet under Service&Support (<https://support.industry.siemens.com/>).

8.1.3 Electromagnetic compatibility

Definition

Electromagnetic compatibility (EMC) is the ability of an electrical installation to function satisfactorily in its electromagnetic environment without interfering with that environment.

Among other things, the PN/MF Coupler also meets the requirements of the EMC legislation for the European single market. The prerequisite for this is that the PN/MF Coupler complies with the requirements and guidelines relating to electrical configuration.

Pulse-shaped interference

The table below shows the electromagnetic compatibility of the described components with regard to pulse-shaped interference. This requires that the system comply with the requirements and guidelines for electrical assembly.

Table 8- 1 Pulse-shaped interference

Pulse-shaped interference	Tested with	Corresponds with degree of severity
Electrostatic discharge in accordance with IEC 61000-4-2	Air discharge: ± 8 kV	3
	Contact discharge: ± 6 kV	3
Burst pulses (fast transient interference) in accordance with IEC 61000-4-4	± 2 kV (power supply cable)	3
	± 2 kV (signal cable >30 m)	4
	± 1 kV (signal cable <30 m)	3
High-energy single pulse (surge) in accordance with IEC 61000-4-5		2
• Symmetric coupling	± 0.5 kV (power supply cable)	
• Asymmetric coupling	± 1 kV (power supply cable to functional earth FE) ± 1 kV (signal cable/data cable to functional earth FE)	

Sinusoidal interference

The following table shows the electromagnetic compatibility of the PN/MF Coupler with regard to sinusoidal interference (HF radiation).

Sinusoidal interference	Test values
HF radiation (electromagnetic fields) according to IEC 61000-4-3	80% amplitude modulation at 1 kHz <ul style="list-style-type: none"> • to 10 V/m from 80 MHz to 1 GHz • to 10 V/m from 1.4 GHz to 2 GHz • to 1 V/m from 2 GHz to 6 GHz
HF current feed on cables and cable shields according to IEC 61000-4-6	Test voltage 10 V at 80 % amplitude modulation of 1 kHz in the range from 10 kHz to 80 MHz

The following table shows the electromagnetic compatibility of the PN/MF Coupler with respect to sinusoidal interference (RF radiation).

Table 8- 2 Sinusoidal interference – RF radiation

RF radiation in accordance with IEC 61000-4-3/NAMUR 21 Electromagnetic RF field, amplitude-modulated	Corresponds with degree of severity
80 to 1000 MHz; 1.4 to 2 GHz	3
10 V/m	
80% AM (1 kHz)	
2.0 GHz to 6 GHz	2
3 V/m	
80% AM (1 kHz)	

The following table shows the electromagnetic compatibility of the PN/MF Coupler with respect to sinusoidal interference (RF coupling).

Table 8- 3 Sinusoidal disturbance variables – RF coupling

RF coupling in accordance with IEC 61000-4-6	Corresponds with degree of severity
10 kHz to 80 MHz	3
10 V _{rms}	
80% AM (1 kHz)	
150 Ω source impedance	

Emission of radio interferences

Emission of interference from electromagnetic fields in accordance with EN 61000-6-4:

Table 8- 4 Interference emission of electromagnetic fields

Frequency	Interference emission
from 30 to 230 MHz	<40 dB (μV/m) Q
from 230 to 1000 MHz	<47 dB (μV/m) Q
from 1 to 3 GHz	<66 dB (μV/m) P
from 3 to 6 GHz	<70 dB (μV/m) P

Emission of interference via AC supply voltage in accordance with EN 61000-6-4: limit class A, group 1.

from 0.15 to 0.5 MHz	< 79 dB (μV)Q < 66 dB (μV)M
from 0.5 to 30 MHz	< 73 dB (μV)Q < 60 dB (μV)M

8.1.4 Transport and storage conditions

Introduction

The described components meet the requirements regarding transport and storage conditions according to IEC 61131-2. The following information applies to modules that are transported and stored in their original packaging.

Transport and storage of modules

Table 8- 5 Transport and storage conditions

Type of condition	Permitted range
Free fall (in shipping package)	≤ 1 m
Temperature	-40 °C to +70 °C
Barometric pressure	1140 hPa to 533 hPa (corresponds to an elevation of -1000 m to 5000 m)
Relative humidity	5% to 95%, without condensation
Sinusoidal vibrations according to IEC 60068-2-6	5 - 8.4 Hz: 3.5 mm 8.4 - 500 Hz: 9.8 m/s ²
Shock according to IEC 60068-2-27	250 m/s ² , 6 ms, 1000 shocks

8.1.5 Mechanical and climatic ambient conditions for operation

Operating conditions

The described components are intended for weather-proof, stationary use.

The device was tested with the following extensions and restrictions in accordance with IEC 60721-3-3 Class 3K3:

Type of condition	Mounting position	Permitted range
Temperature	horizontal	-30 ... 60 °C (without condensation)
Temperature	vertical	-30 ... 50 °C (without condensation)
Barometric pressure ¹ , altitude	1140 ... 533 hPa, corresponds with an altitude of -1000 to 5000 m	
Relative humidity	From 10% to 90%, no condensation	
Pollutant concentration	SO ₂ : < 0.5 ppm; relative humidity < 60%, no condensation H ₂ S: < 0.1 ppm; relative humidity < 60%, no condensation	

¹ No pressure differential permitted inside and outside of housing/control cabinet

Use with additional measures

Without additional measures the described components must **not** be used in the following locations:

- Locations with a high amount of ionizing radiation
- Locations with difficult operating conditions; e.g. caused by
 - Dust formation
 - Corrosive vapors or gases
 - Strong electrical or magnetic fields
- Equipment that requires special monitoring, e.g.
 - Elevators
 - Electrical equipment in especially hazardous areas

Mechanical environmental conditions

The following table specifies the mechanical environmental conditions for the described components for sinusoidal vibrations.

Table 8- 6 Mechanical environmental conditions

Frequency range	PN/MF Coupler for operation with a BusAdapter without an RJ45 socket	PN/MF Coupler for operation with a BusAdapter with an RJ45 socket
$5 \leq f \leq 8.4$ Hz	3.5 mm amplitude	
$8.4 \leq f \leq 150$ Hz	1 g constant acceleration	
$10 \leq f \leq 60$ Hz	0.35 mm amplitude	---
$60 \leq f \leq 1000$ Hz	5 g constant acceleration	

Reduction of vibrations

If the described components are exposed to stronger shocks or vibrations, take appropriate measures to reduce the acceleration or the amplitude.

We recommend mounting the described components on damping materials (for example, rubber-metal vibration dampers).

Tests for mechanical environmental conditions

The following table provides information about the type and scope of the tests for environmental mechanical conditions.

Table 8- 7 Tests for mechanical environmental conditions

Test for ...	Test standard	Comment
Vibrations	Vibration test according to IEC 60068-2-6 (sinusoidal)	Type of vibration: Frequency sweeps with a rate of change of 1 octave/minute. BusAdapter with an RJ45 socket <ul style="list-style-type: none"> • $5 \text{ Hz} \leq f \leq 8.4 \text{ Hz}$, 3.5 mm constant amplitude • $8.4 \text{ Hz} \leq f \leq 150 \text{ Hz}$, 1 g constant acceleration BusAdapter without an RJ45 socket <ul style="list-style-type: none"> • $10 \text{ Hz} \leq f \leq 60 \text{ Hz}$, 0.35 mm constant amplitude • $60 \text{ Hz} \leq f \leq 1000 \text{ Hz}$, 5 g constant acceleration Duration of vibration: 10 frequency sweeps per axis in each of three perpendicular axes
Shock	Shock, tested according to IEC 60068-2-27	Type of shock: Half-sine Shock intensity: 150 m/s ² peak value, 11 ms duration Direction of shock: 3 shocks in +/- direction in each of three perpendicular axes
Continuous shock	Shock, tested according to IEC 60068-2-27	Type of shock: Half-sine Shock intensity: 25 g peak value, 6 ms duration Direction of shock: 1000 shocks in +/- direction in each of three perpendicular axes

Climatic environmental conditions

The described components may be used in the following climatic ambient conditions:

Table 8- 8 Climatic environmental conditions

Environmental conditions	Permitted range
Temperature: horizontal installation vertical installation	from 0 to 60 °C (without condensation) from 0 to 50 °C (without condensation)
Relative humidity	from 10% to 90%,
Barometric pressure	from 1140 to 533 hPa
Pollutant concentration	ISA-71.04 severity level G1; G2; G3

Using the ET 200SP distributed I/O system over 2000 m above sea level

The maximum "operating height above sea level" depends on the module and is described in the technical specifications of the respective module. The product data sheets with daily updated technical specifications can be found on the Internet (<https://support.industry.siemens.com/cs/ww/en/ps/td>) at Industry Online Support. Enter the article number or the short description of the desired module on the website.

For altitudes > 2000 m, the following constraints apply to the maximum specified ambient temperature:

Restrictions of the specified maximum ambient temperature in reference to the installation altitude

Installation altitude	Derating factor for ambient temperature ¹⁾
-1000 m to 2000 m	1.0
2000 m to 3000 m	0.9
3000 m to 4000 m	0.8
4000 m to 5000 m	0.7

¹⁾ Base value for application of the derating factor is the maximum permissible ambient temperature in °C for 2000 m.

Note

- Linear interpolation between altitudes is permissible.
- The derating factors compensate for the decreasing cooling effect of air at higher altitudes due to lower density.
- Note the mounting position of the respective module in the technical specifications. The basis is the standard IEC 61131-2:2017.
- Make sure that the power supplies you use are rated for altitudes > 2000 m.

8.1.6 Specifications for insulation tests, safety class and degree of protection

Isolation

The insulation is designed in accordance with the requirements of 61010-2-201.

Note

Galvanic isolation with 707 V DC (Type Test) is tested for modules with 24 V DC supply voltage (SELV/PELV).

Pollution degree/overvoltage category according to 61010-2-201

- Pollution degree 2
- Overvoltage category: II

Protection class according to 61010-2-201

The entire system meets protection class I and includes parts of protection classes II and III. The PN/MF Coupler contains electric circuits of protection class III.

The grounding of the mounting rail must meet the requirements for a functional earth FE.

Recommendation: For an interference-proof setup, the ground conductor should have a cross-section $> 6 \text{ mm}^2$.

To meet the requirements of protection class I, the installation location (e.g. enclosure, control cabinet) must have a protective conductor connection conforming to standards.

Degree of protection IP20

Degree of protection IP20 in accordance with IEC 60529 for the PN/MF Coupler, i.e.:

- Protection against contact with standard test finger
- Protection against foreign objects with diameters greater than 12.5 mm
- No protection against water

8.1.7 Rated voltage

Rated voltage for operation

The components described operate with a nominal voltage of 24 V DC (SELV/PELV). The tolerance range is from 19.2 to 28.8 V DC.

8.2 Technical specifications PN/MF Coupler (6ES7158-3MU10-0XA0)

Technical specifications of PN/MF Coupler

The following table shows the technical specifications as of 07/2020. You can find a data sheet including daily updated technical specifications on the Internet (<https://support.industry.siemens.com/cs/ww/en/pv/6ES7158-3MU10-0XA0/td?dl=en>).

Article number	6ES7158-3MU10-0XA0
General information	
Product type designation	PN/MF coupler
Firmware version	V5.0.1
<ul style="list-style-type: none"> FW update possible 	Yes
Vendor identification (VendorID)	002AH
Device identifier (DeviceID)	0604H
Manufacturer ID according to ODVA (VendorID)	04E3H
Device ID according to ODVA (Product code)	0FA0H
Product function	
<ul style="list-style-type: none"> I&M data 	Yes; I&M0 to I&M3
<ul style="list-style-type: none"> Isochronous mode 	No
<ul style="list-style-type: none"> Tool changer 	Yes; Docking station and docking unit
<ul style="list-style-type: none"> Local coupling, IO data 	No
<ul style="list-style-type: none"> Local coupling, data records 	No
Engineering with	
<ul style="list-style-type: none"> STEP 7 TIA Portal configurable/integrated from version 	STEP 7 V16 or higher with HSP
<ul style="list-style-type: none"> STEP 7 configurable/integrated from version 	Configurable via GSD file
<ul style="list-style-type: none"> PROFINET from GSD version/GSD revision 	V2.3
Installation type/mounting	
Mounting	Mounting rail 7.5 mm and 15 mm
Supply voltage	
Rated value (DC)	24 V
permissible range, lower limit (DC)	19.2 V
permissible range, upper limit (DC)	28.8 V
Reverse polarity protection	Yes
Mains buffering	
<ul style="list-style-type: none"> Mains/voltage failure stored energy time 	10 ms
Input current	
Current consumption, max.	360 mA; for 19.2 V input voltage at the right-hand supply terminal, including 2 plugged BA
Inrush current, max.	1.6 A
I^2t	0.031 A ² ·s
from supply voltage 1L+, max.	320 mA; for 19.2 V input voltage at the left-hand supply terminal, including 2 plugged BA

Article number	6ES7158-3MU10-0XA0
Power loss	
Power loss, typ.	4 W; For 24 V input voltage and 2 plugged BA 2x RJ45 If BusAdapters with an optical interface are plugged, there is an additional 750 mW per optical interface (3 W with 2 plugged BA 2x LC)
Address area	
Address space per module	
<ul style="list-style-type: none"> Address space per module, max. 	254 byte; max. 254 bytes of input data and 253 bytes of output data
Address space per station	
<ul style="list-style-type: none"> Address space per station, max. 	1 440 byte; per input / output
Hardware configuration	
Submodules	
<ul style="list-style-type: none"> Number of submodules per station, max. 	116
Interfaces	
Number of PROFINET interfaces	2; One PROFINET interface per line side
Optical interface	No
1. Interface	
Interface types	
<ul style="list-style-type: none"> Number of ports integrated switch BusAdapter (PROFINET) 	2; via BusAdapter Yes Yes; compatible BusAdapters: BA 2x RJ45, BA 2x FC, BA 2x M12
Protocols	
<ul style="list-style-type: none"> PROFINET IO Device Open IE communication Media redundancy 	Yes Yes Yes; as MRP client, maximum of 50 nodes in the ring
2. Interface	
Interface types	
<ul style="list-style-type: none"> Number of ports integrated switch 	2; via BusAdapter Yes
Protocols	
<ul style="list-style-type: none"> PROFINET IO Device Open IE communication Media redundancy 	Yes Yes Yes; as MRP client, maximum of 50 nodes in the ring
Interface types	
RJ 45 (Ethernet)	
<ul style="list-style-type: none"> Transmission procedure 10 Mbps Autonegotiation Autocrossing 	PROFINET with 100 Mbit/s full duplex (100BASE-TX) No Yes Yes

8.2 Technical specifications PN/MF Coupler (6ES7158-3MU10-0XA0)

Article number	6ES7158-3MU10-0XA0
Protocols	
Supports protocol for PROFINET IO	Yes
Modbus TCP	No
Protocols (Ethernet)	
• TCP/IP	Yes
• SNMP	Yes
• LLDP	Yes
• ping	Yes
• ARP	Yes
PROFINET IO Device	
Services	
– IRT	No
– PROFINET energy	No
– Prioritized startup	Yes
– Shared device	No
Redundancy mode	
• PROFINET system redundancy (S2)	No
Media redundancy	
– MRP	Yes
– MRPD	No
EtherNet/IP	
Services	
– CIP Implicit Messaging	Yes
– CIP Explicit Messaging	Yes
– CIP Safety	No
Updating times	
– Requested Packet Interval (RPI)	2 ms
Address area	
– Address space per module, max.	244 byte; (244 byte outputs / 244 byte inputs)
– ForwardOpen (Class1 & 32 bit Header)	500 byte; (496 byte outputs / 500 byte inputs)
– LargeForwardOpen (Class3)	4 002 byte
Open IE communication	
• TCP/IP	Yes
• SNMP	Yes
• LLDP	Yes
Interrupts/diagnostics/status information	
Status indicator	Yes
Alarms	Yes
Diagnostics function	Yes; Parameterizable

Article number	6ES7158-3MU10-0XA0
Diagnostics indication LED	
• RUN LED	Yes; green LED
• ERROR LED	Yes; red LED
• MAINT LED	Yes; Yellow LED
• Monitoring of the supply voltage (PWR-LED)	Yes; green PWR LED
• NS LED	Yes; green/red LED
• MS LED	Yes; green/red LED
• IO LED	Yes; red-green-yellow LED
• Connection to network LINK (green)	Yes; 2x green link LEDs on BusAdapter
Potential separation	
between supply voltage and electronics	Yes; to power input 2
between Ethernet and electronics	Yes
Isolation	
Isolation tested with	707 V DC (type test)
Standards, approvals, certificates	
network separator in accordance with IEC 61784-3-3	Yes
Network loading class	3
Security level	According to Security Level 1 Test Cases V1.1.4
Ambient conditions	
Ambient temperature during operation	
• min.	-30 °C; No condensation
• max.	60 °C; = Tmax for horizontal installation; for vertical installation Tmax = 50 °C
Altitude during operation relating to sea level	
• Installation altitude above sea level, max.	5 000 m; restrictions for installation altitudes > 2 000 m, see section "Climatic and mechanical environmental conditions"
Mechanics/material	
Strain relief	Yes; Optional, for RJ45 and FC BusAdapter only
Dimensions	
Width	100 mm
Height	117 mm
Depth	74 mm; with mounting rail
Weights	
Weight, approx.	200 g; without BusAdapter

Dimension drawing

Dimension drawing

Dimension drawing for PN/MF Coupler (dimensions in mm):

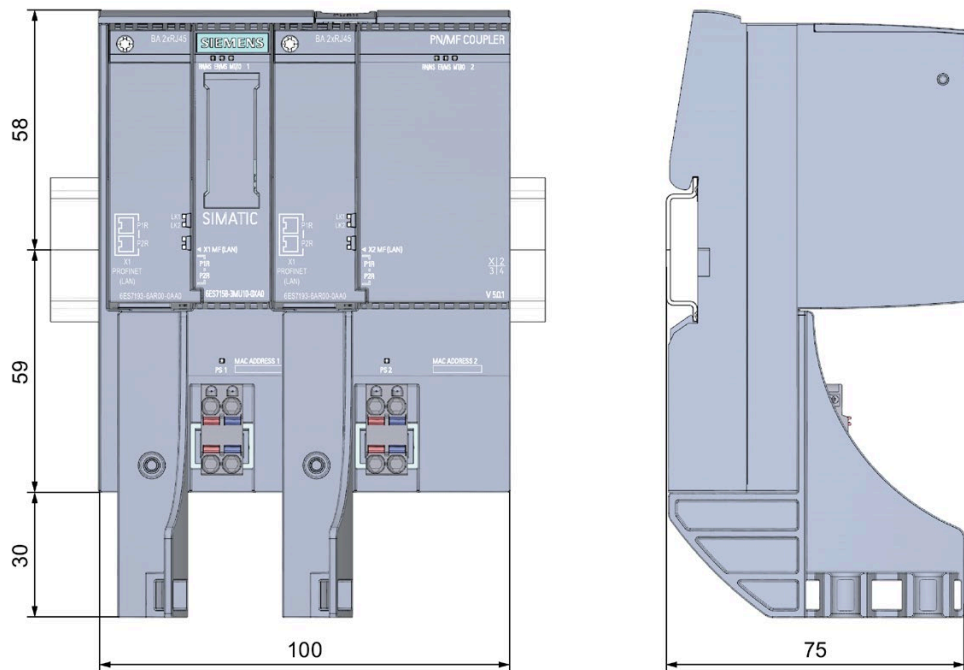

The mounting rail is 7.5 mm deep in the dimension drawing. You can also use a mounting rail with 15 mm.

Article numbers and accessories

Overview

Table B-1 Article numbers for the PN/MF Coupler

Component	Number in pack	Article number
PN/MF Coupler	1 unit	6ES7158-3AD10-0XA0
BusAdapter		
<ul style="list-style-type: none"> BA 2×RJ45 (PROFINET BusAdapter with standard Ethernet socket) 	1 unit	6ES7193-6AR00-0AA0
<ul style="list-style-type: none"> BA 2×FC (PROFINET BusAdapter with FastConnect Ethernet connection) 	1 unit	6ES7193-6AF00-0AA0
<ul style="list-style-type: none"> BA 2×M12 (PROFINET BusAdapter with M12 connection) 	1 unit	6ES7193-6AM00-0AA0
Cover for the BusAdapter interface	5 units	6ES7591-3AA00-0AA0
24 V DC connector	10 units	6ES7193-4JB00-0AA0
Reference identification label, sheet with 16 labels	10 units	6ES7193-6LF30-0AW0
Labeling strips (for labeling the I/O modules)		
<ul style="list-style-type: none"> Roll, light gray labeling strips (with a total of 500 strips), film, for labeling with thermal transfer roll printer 	1 unit	6ES7193-6LR10-0AA0
<ul style="list-style-type: none"> Roll, yellow labeling strips (with a total of 500 strips), film, for labeling with thermal transfer roll printer 	1 unit	6ES7193-6LR10-0AG0
<ul style="list-style-type: none"> DIN A4 sheets, light gray labeling strips (with a total of 1000 labels), paper, perforated, for labeling with laser printer 	10 units	6ES7193-6LA10-0AA0
<ul style="list-style-type: none"> DIN A4 sheets, yellow labeling strips (with a total of 1000 labels), paper, perforated, for labeling with laser printer 	10 units	6ES7193-6LA10-0AG0
Mounting rails, tin-plated steel strip		
<ul style="list-style-type: none"> Length: 483 mm 	1 unit	6ES5710-8MA11
<ul style="list-style-type: none"> Length: 530 mm 	1 unit	6ES5710-8MA21
<ul style="list-style-type: none"> Length: 830 mm 	1 unit	6ES5710-8MA31
<ul style="list-style-type: none"> Length: 2000 mm 	1 unit	6ES5710-8MA41
Strain relief	5 units	6ES7193-6RA00-1AN0

Response times

Response times

The time that elapses between an IO controller writing to the process image outputs and when this data can be read in the process image of the second IO controller depends on the following:

- CPU cycle time of the two IO controllers
- Bus cycle time of the associated IO controller
- Duration for copying within the PN/MF Coupler (T_{COPY})
- Total data length in bytes (input/output)

The copying duration of the PN/MF Coupler is independent of the data transmission rate used. It consists of the copy routine for the inputs and for the outputs. The following maximum values apply:

$$T_{COPY} = 25 \mu s + n_{IN} \times 0.06 \mu s + n_{OUT} \times 0.03 \mu s + (n_{SUB}-1) \times 3.5 \mu s$$

- n_{IN} : Number of bytes of inputs
- n_{OUT} : Number of bytes of outputs
- n_{SUB} : Number of submodules used

Influencing factors for the response times









The following applies to time-critical applications:

- Divide the data among as few modules and submodules as possible.
- Exchange as little data as possible via the PN/MF Coupler.
- Do not request diagnostic data from the IO controller.
- Do not activate the data validity display DIA.
- Do not activate the data validity diagnostics.

Safety-related symbols











D.1 Safety-related symbols for devices without Ex protection

The following table contains an explanation of the symbols located in your SIMATIC device, its packaging or the accompanying documentation.



Symbol	Meaning
	General warning sign Caution/Notice You must read the product documentation. The product documentation contains information about the potential risks and enable you to recognize risks and implement countermeasures.
	Read the information provided by the product documentation. ISO 7010 M002
	Ensure the device is only installed by electrically skilled person. IEC 60417 No. 6182
 CABLE SPEC.	Note that connected mains lines must be designed according to the expected minimum and maximum ambient temperature.
 EMC	Note that the device must be constructed and connected in accordance with EMC regulations.
 230V MODULES	Note that a 230 V device can be exposed to electrical voltages which can be dangerous. ANSI Z535.2
 24V MODULES	Note that a device of Protection Class III may only be supplied with a protective low voltage according to the standard SELV/PELV. IEC 60417-1-5180 "Class III equipment"
 INDOOR USE ONLY INDUSTRIAL USE ONLY	Be aware that the device is only approved for the industrial field and only for indoor use.
	Note that an enclosure is required for installing the device. Enclosures are considered: <ul style="list-style-type: none"> • Standing control cabinet • Serial control cabinet • Terminal boxes • Wall enclosure

D.2 Safety-related symbols for devices with Ex protection

The following table contains an explanation of the symbols located in your SIMATIC device, its packaging or the accompanying documentation.

Symbol	Meaning
	<p>The assigned safety symbols apply to devices with Ex approval.</p> <p>You must read the product documentation. The product documentation contains information about the potential risks and enable you to recognize risks and implement countermeasures.</p>
	<p>Read the information provided by the product documentation.</p> <p>ISO 7010 M002</p>
	<p>Ensure the device is only installed by electrically skilled person.</p> <p>IEC 60417 No. 6182</p>
	<p>Observe the mechanical rating of the device.</p>
	<p>Note that connected mains lines must be designed according to the expected minimum and maximum ambient temperature.</p>
	<p>Note that the device must be constructed and connected in accordance with EMC regulations.</p>
	<p>When the device is under voltage, note that it may not be installed or removed, or plugged or pulled.</p>
	<p>Note that a 230 V device can be exposed to electrical voltages which can be dangerous.</p> <p>ANSI Z535.2</p>
	<p>Note that a device of Protection Class III may only be supplied with a protective low voltage according to the standard SELV/PELV.</p> <p>IEC 60417-1-5180 "Class III equipment"</p>
	<p>Be aware that the device is only approved for the industrial field and only for indoor use.</p>

D.2 Safety-related symbols for devices with Ex protection

Symbol	Meaning
 <p data-bbox="355 363 528 406">ZONE 2 INSIDE CABINET IP54</p>	<p data-bbox="555 285 1422 342">For Zone 2 potentially explosive atmospheres, be aware that the device may only be used when it is installed in an enclosure with a degree of protection \geq IP54.</p>
 <p data-bbox="355 502 528 544">ZONE 22 INSIDE CABINET IP6x</p>	<p data-bbox="555 423 1433 480">For Zone 22 potentially explosive atmospheres, be aware that the device may only be used when it is installed in an enclosure with a degree of protection \geq IP6x.</p>

Glossary

Autonegotiation

Configuration protocol in Fast Ethernet. Before the actual data transfer, the devices on the network agree on a transfer mode that each participating device can work with (100 Mbps or 10 Mbps, full-duplex or half-duplex).

Bus

A common transfer route connecting all nodes and having two defined ends.

BusAdapter

Enables free selection of the connection technology and layout for the PROFINET fieldbus.

Cross-over cable

A cross-over cable is a four-wire or eight-wire twisted pair cable in which specific cable wires are swapped in one of the two RJ45 connectors. You can use a cross-over cable to connect two controllers directly with each other.

Data record routing

Forwarding of data records beyond subnet boundaries from a sender to receivers via a router.

Data status byte (for inputs only)

Users need the data status byte (DS) to check the validity of the coupled user data. An additional byte is added to all input modules; it can be evaluated in the user program.

Device name

Before an IO Device can be addressed by an IO Controller, it must have a device name. This procedure was selected for PROFINET because names are easier to handle than complex IP addresses.

Assignment of a device name for a specific IO Device can be compared with the setting of the PROFIBUS address for a DP slave.

An IO Device does not have a device name upon delivery. Only once a device name has been assigned using the PG/PC, can an IO Device be addressed by an IO Controller, e.g. for the transmission of configuring data (including the IP address) during start-up or for the exchange of useful data in cyclic mode.

Device replacement without removable medium/programming device

IO Devices having this function can be replaced simply:

- A removable medium (such as Micro Memory Card) with the stored device name is not required.
- The device name does not have to be assigned using the programming device.

The replaced IO Device receives the device name from the IO Controller, not from the removable medium or from the programming device. For this purpose, the IO Controller uses the configured topology and the neighborhood relationships determined by the IO Devices. The configured setpoint topology must agree with the actual topology.

Diagnostics

Diagnostics is the detection, localization, classification, display and further evaluation of errors, faults, and messages.

Diagnostics provides monitoring functions that run automatically while the system is in operation. This increases the availability of systems by reducing setup times and downtimes.

Earth

The conductive earth whose electric potential can be set to zero at any point.

Electromagnetic compatibility (EMC)

Electromagnetic compatibility is understood as the ability of a piece of electrical equipment to function perfectly in a specified environment without impacting on its surroundings in an impermissible way.

Equipment, electrical

All components, power circuits or parts of power circuits that are normally to be found in one single enclosure.

Equipotential bonding

Electrical connection (equipotential bonding conductor) that brings the conductive parts of electrical equipment and other conductive parts to the same or approximately the same potential in order to prevent troublesome or dangerous voltages arising between these parts.

EtherNet/IP adapter

The EtherNet/IP adapter corresponds to the PROFINET IO device.

EtherNet/IP scanner

The EtherNet/IP scanner corresponds to the PROFINET IO controller.

External lightning protection

External lightning protection is part of the lightning protection system and comprises an interception device, an arrester and a grounding system. In the event of a lightning strike, the external lightning protection serves to divert the lightning current safely to the ground.

Corresponds with lightning protection zone O_A and O_B .

Fast Ethernet

Fast Ethernet describes the standard for transmitting data at 100 Mbps. This transfer technology uses the 100 Base-T standard for this.

Firmware update

Updating of firmware of interface module

After (compatible) function extensions or after improvements to performance, the interface module can be updated to the latest firmware version.

Ground

The ground refers to all the interconnected inactive parts of a piece of equipment that, even in the event of a fault, cannot pick up voltage that is dangerous to touch.

Grounding

Grounding means connecting an electrically conductive part to a grounding system by means of the ground electrode.

GSD file

The properties of a PROFINET device are described in a GSD file (General Station Descriptor), which contains all the information required for configuration.

As with PROFIBUS, you can link a PROFINET device in STEP 7 by means of a GSD file.

In PROFINET IO, the GSD file is always in XML format. The structure of the GSD file corresponds to ISO 15734, the worldwide standard for device descriptions.

HW Config

Part of STEP 7 for configuring hardware.

Isochronous real-time communication

Synchronized transmission method for the cyclic exchange of IRT data between PROFINET devices.

A reserved bandwidth is available within the send cycle for IRT IO data. The reserved bandwidth guarantees that IRT data can also be transferred at reserved, synchronized intervals while other, higher network loads are active (for example, TCP/IP communication, or additional real-time communication).

LAN

Local Area Network; interconnects multiple computers within a company. The geographical topology of a LAN is limited to the local premises and is only available to the operating company or institution.

LLDP

LLDP (Link Layer Discovery Protocol) is a protocol that is used to detect the closest neighbors. It enables a device to send information about itself and to save information received from neighboring devices in the LLDP MIB. This information can be looked up via the SNMP. This information allows a network management system to determine the network topology.

MAC address

Each PROFINET device is assigned a worldwide unique device identifier in the factory. This 6-byte long device identifier is the MAC address.

The MAC address consists of:

- 3-byte manufacturer ID and
- 3-byte device ID (sequential number).

The MAC address is placed legibly on the front of the device
e.g.: 08-00-06-6B-80-C0

MDI

In network connections it is normal for each device to be equipped with separate cable wires for transmitting and receiving. The network sockets (MDI) must be coupled in such a way that the transmit wire of one device lines up with the receive wire of the other device. If you use a cross-over cable, the wires are thereby interchanged (crossed) and communication is possible without additional devices.

MDI-X

The MDI-X connection type refers to a socket that is already internally crossed in the device. It is common in distribution devices, such as switches.

MF Device

A device that supports EtherNet/IP. For example, PN/MF Coupler or IM155-6 MF HF.

Parameter assignment

The term parameterization denotes the transfer of parameters from the IO Controller to the IO Device.

PELV

Protective Extra Low Voltage = extra low voltage with safe isolation that is grounded.

Power supply unit

A power supply unit supplies power to the field devices and the distributed process I/Os connected to them.

Prioritized startup

Prioritized startup denotes PROFINET functionality for accelerating the startup of IO Devices in a PROFINET IO system with RT and IRT communication. The function reduces the time that the correspondingly configured IO Devices require in order to return to the cyclic user data exchange in the following cases:

- After the supply voltage has returned
- After station recovery
- After IO Devices have been activated

Process image

The process image is part of the IO Controller's system memory. The signal states of the input modules are transferred to the process-image inputs at the beginning of the cyclic program. At the end of the cyclic program, the process image of the outputs is transferred to the IO Controller as signal status.

PROFIBUS International

Technical committee dedicated to the definition and development of the PROFIBUS and PROFINET standard.

PROFINET

Within the context of Totally Integrated Automation (TIA), PROFINET is the systematic continuation of the following systems:

- PROFIBUS DP, the established fieldbus
- Industrial Ethernet, the communication bus for the cell level

Experiences from both systems have been and are being integrated in PROFINET.

PROFINET is an Ethernet-based automation standard of PROFIBUS International (previously PROFIBUS User Organization e.V.), and defines a multi-vendor communication, automation, and engineering model. PROFINET has been part of IEC 61158 since 2003.

See PROFIBUS International

PROFINET components

A PROFINET component includes all data of the hardware configuration, the parameters of the modules, and the associated user program. The PROFINET component comprises the following elements:

- Technological function

The (optional) technological (software) function includes the interface to other PROFINET components as interconnectable inputs and outputs.

- Device

The device represents the physical automation device or field device, including the IO, sensors and actuators, mechanical system, and device firmware.

PROFINET device

A PROFINET device always has at least one Industrial Ethernet port. Additionally, a PROFINET device can have a PROFIBUS connection: as master with proxy functions In exceptions, a PROFINET device can also have a several PROFIBUS connections (for example CP 5614).

PROFINET IO Controller

Device by means of which connected IO Devices are addressed. In other words: The IO Controller exchanges input and output signals with the assigned field devices. The IO Controller is often the controller in which the automation program is executed.

PROFINET IO

Within the context of PROFINET, PROFINET IO is a communication concept for implementing modular, distributed applications.

PROFINET IO allows you to create automation solutions familiar from PROFIBUS.

Implementation of PROFINET IO is carried out on the one hand via the PROFINET standard for automation devices and on the other by using the engineering tool STEP 7.

This means that you have the same application layer in STEP 7 – regardless of whether you configure PROFINET devices or PROFIBUS devices The programming of your user program is identical for PROFINET IO and PROFIBUS DP when you use the blocks and system status lists expanded for PROFINET IO.

PROFINET IO Device

Distributed field device which is assigned to one of the IO controllers (e.g. remote IO, valve terminals, frequency converters, switches).

Reference potential

Potential that is used to view and/or measure voltages for each circuit involved.

SELV

Safety extra low voltage (SELV) is voltage ≤ 30 V AC/60 V DC that is generated via a safety transformer or accumulator.

SNMP

SNMP (Simple Network Management Protocol) is the standardized protocol, for diagnosing and also configuring the Ethernet network infrastructure.

In the office setting and in automation engineering, devices from many different manufacturers support SNMP on the Ethernet.

SNMP-based applications can be operated on the same network in parallel to applications with PROFINET.

The scope of the supported functions differs depending on the device type. For example, a switch has more functions than a CP 1616.

Switch

PROFIBUS is a linear network. The communication nodes are connected with one another by means of a passive line - the bus.

By contrast, the Industrial Ethernet consists of point-to-point connections: each communication node is directly connected to exactly one communication node.

If a communication node is connected with several communication nodes, this communication node is connected to the port of an active network component - the switch. Additional communication nodes (including switches) can now be connected to the other ports of the switch. The connection between a communication node and the switch remains a point-to-point connection.

A switch also has the task of regenerating and distributing received signals. The switch "learns" the Ethernet address(es) of a connected PROFINET device or other switches and only forwards signals, which are destined for the connected PROFINET device or the connected switch.

A switch has a specific number of ports. You connect at most one PROFINET device or additional switch to each port.

TN-S system

In a TN-S system, the neutral conductor (N) and protective conductor (PE) are wire with separate insulation. The neutral conductor is connected to the grounded protective conductor at a central point, and only there. The protective conductor can be grounded any number of times.

Transmission rate

The transmission rate specifies the number of bits transmitted per second.

ungrounded

Having no conductive connection to earth

User data flag

Each IO module is assigned a value in the input or output data message; this value provides a statement on the quality of this user datum. For example, outputs of a specific module can be switched off by means of this without affecting other modules.

Index

2

- 24 V DC connector, 130
- 24 V DC power supply, 28

A

- Accessories, 18, 130
- Approval
 - ATEX, 114
 - CE, 112
 - cULus, 112
 - cULus HAZ. LOC., 113
 - IECEX, 115
- Approvals, 110
 - FM, 114
 - IEC 61010, 116
- Area of application, 12
- Article number, 16, 130
- Assignment of the modules, 40
- ATEX approval, 114

B

- Basic knowledge, 3
- BusAdapter, 130

C

- CE approval, 112
- Climatic environmental conditions, 123
- Commissioning, 47
- Components for mounting, 22
- Configuring
 - Overview, 39
 - with a different configuration tool, 41
 - with GSD file, 41
 - with STEP 7 TIA Portal, 42
- Configuring with STEP 7 TIA Portal
 - Example, 43
- Connections, 29
- cULus approval, 112
- cULus HAZ. LOC approval, 113
- Customer benefits, 12

D

- Data status byte, 56
- Data validity display, 56
- Degree of protection, 124
- Delivery state, 108
- Device name
 - Deleting, 108
- Device replacement, 35
- Diagnostic data records
 - Structure, 56
- Diagnostics
 - after IO controller STOP, 57
 - after recovery of the IO device, 57
 - Extended channel diagnostics, 53
 - Options for reading out, 56
- Diagnostics interrupt, 55
- Dimension drawing, 129
- Display elements, 19, 50
- Disposal, 3

E

- Electrical isolation, 27
- Electromagnetic compatibility (EMC), 118
- EMC (Electromagnetic compatibility), 118
- EMERGENCY STOP equipment, 28
- Environmental conditions
 - Climatic, 123
 - Mechanical, 122, 122
 - Operation, 121
 - Transport and storage, 120
- Equipment
 - Open, 21
- ER (LED), 50
- Error displays, 50
- Extended channel diagnostics, 53

F

- Factory settings
 - Delivery state, 108
 - Resetting to, 108
- FM approval, 114

G

Galvanic properties, 27
Grounding, 27
GSD file, 41
 of STEP 7 TIA Portal, 44

I

Identification data, 48
IEC 61010, 116
IEC 61131, 116
IECEX approval, 115
Installation
 Ungrounded, 27
Installation rules
 Mounting position, 21
Interfaces, 19
Interference
 Pulse-shaped, 118
 sinusoidal, 119
Interrupt
 Diagnostics interrupt, 55
IO controller STOP
 Subsequent diagnostics, 57
Isolation, 124

K

Korea Certification, 115

L

Labeling strips, 130
LEDs, 50
Lightning protection
 24 V DC power supply, 28
LK (LED), 50

M

Maintenance alarm, 55
Marine approval, 116
Marking for the Eurasian Customs Union, 115
Mechanical environmental conditions, 122
Media redundancy, 36
Module replacement, 107
Modules
 Assignment, 40
Mounting, 22
Mounting position, 21

Mounting rail, 130
Mounting technology, 21
MT (LED), 50

O

Operating conditions, 121

P

Parameter, 45
PN/MF Coupler
 as docking station, 37
 as docking unit, 37
 Mounting, 22
 Parameter assignment, 45
 Replacing, 107
 Uninstalling, 23
Power supply
 Connecting, 30
 on both sides, 30
Principle of operation, 13
Prior knowledge, 3
PROFINET IO
 Standard, 116
Properties, 17, 27
 via EtherNet/IP IO, 18
 via PROFINET IO, 18
Protection class, 124, 124
PS (LED), 50
Purpose of this manual, 3

R

Radio interference, 117
Radio interferences
 Emission of, 120
Rated voltage, 124
RCM Declaration of conformity for Australia/New Zealand, 115
Reading out service data, 57
Recovery of the IO device
 Subsequent diagnostics, 57
Recycling, 3
Reference identification label, 130
Replacement
 Defective PN/MF Coupler, 107
Response times, 131
 Influencing factors, 131
RN (LED), 50

S

- Safety rules, 111
- Scope, 3
- Standard mounting rail, 22
- Standards, 110, 112
- Status and error displays
 - LEDs, 51
- Status displays, 50
- Strain relief, 25, 130

T

- Technical specifications
 - Electromagnetic compatibility (EMC), 118
 - PN/MF Coupler, 125
 - Standards and approvals, 110
- Test voltage, 124
- Two-sided power supply, 30

U

- Ungrounded installation, 27
- Uninstalling, 23
- Updating firmware, 106
- Use
 - in industrial environments, 117
 - in mixed areas, 117
 - in residential areas, 117

V

- Vibrations, 122
- View, 16

W

- WEEE mark (European Union), 116