

# SIEMENS

## INSTALLATION INSTRUCTIONS

### Model VCC2002-A1 Voice input/Output Card

The Model VCC2002-A1 Voice I/O card is installed into the FV2025/2050 Fire Voice Control Panel of the FS20 system. Together with the VCC2001-A1 Voice CPU card and one or more VCI2001-U1 Amplifier cards, it enables voice announcements to be made through the Fire/Voice system.

---

## FEATURES

The principal features of the VCC2002-A1 include:

- The internal codec:
  - Converts analog audio from microphones, Mass Notification Systems (MNS), and other external sources into digital audio signals
  - Converts digital audio signals to analog for use in other parts of the system or with external equipment
- Attenuation and amplification of incoming audio
- Connections for optional remote microphones and voice switch modules
- CAN repeater for externally connected modules (Channel 1 only)
- Connections for two (2) configurable, simultaneous audio input channels and two (2) audio output channels, 1 internal and 1 external
- 24VDC power distribution, current limiting, and short circuit protection for modules connected to the Card Cage
- Operational status via LED displays
- Two volume controls (Future use)
- EMC compliant
- ROHS compliant and meets performance specifications within the industrial temperature range
- Can be used in the UL and ULC market

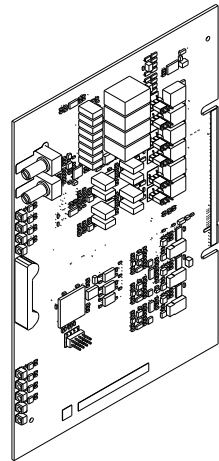

Figure 1  
VCC2002-A1  
Voice I/O Card

---

## PRE-INSTALLATION

Before installing the VCC2002-A1 Voice I/O Card into the VCA2002-A1 Card Cage, set the jumpers on the card to either supervise or not supervise the input and output audio lines. Supervision refers to the automatic monitoring of signal lines for short or open circuit conditions. A supervised line will have an end-of-line (EOL) resistor at the end of the line to set a DC bias level. When the resistor is present, the DC voltage is at a certain value. This DC voltage level will change if the line is either open-circuited or shorted. This DC bias voltage is monitored by an analog-to-digital converter which enables the system to read all the voltage levels and determine if a short or open has occurred.

Figure 2 illustrates the locations of the jumpers on the Voice I/O Card and Table 1 lists the jumper settings that are used to activate supervision for the input and output channels. Both jumpers for each channel must be in the same position, either supervised or unsupervised, for the card to operate correctly.

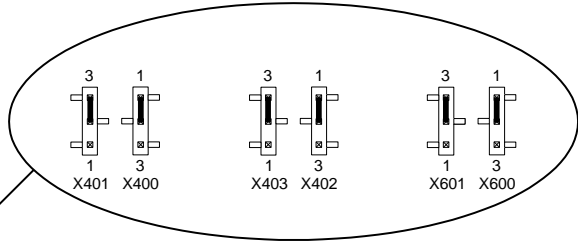
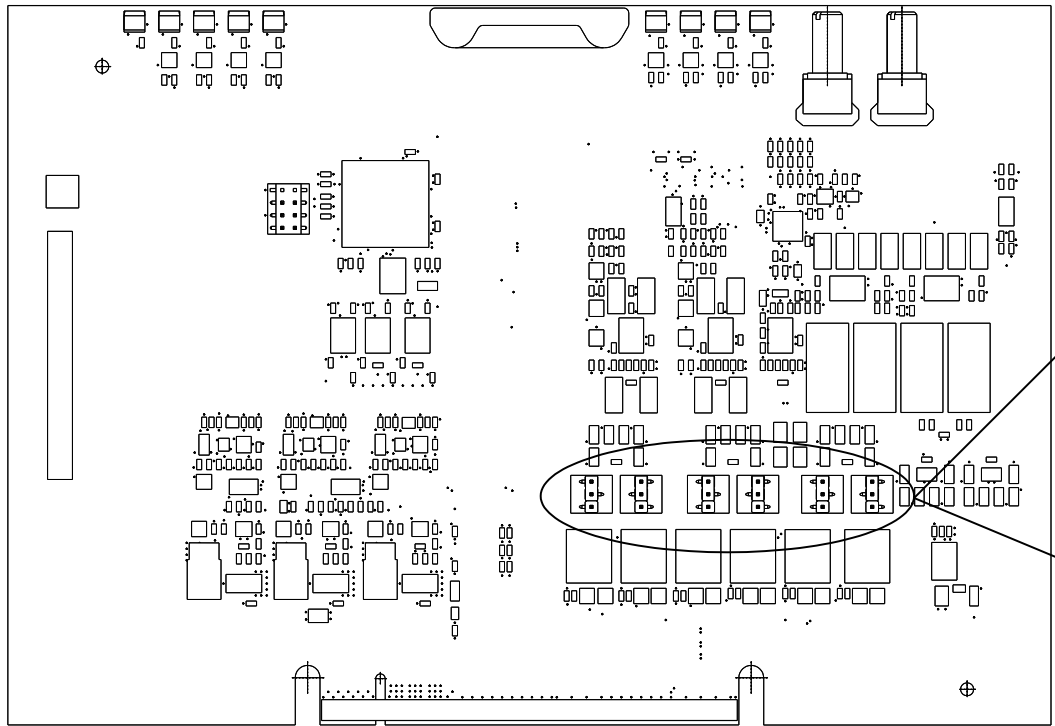

Example 1: Supervision Selected for All Channels

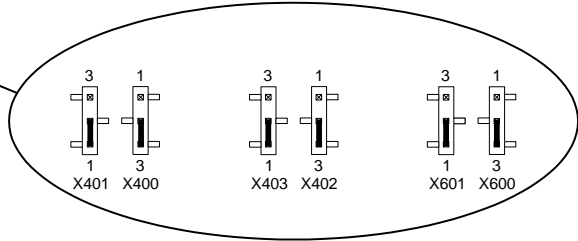

Example 2: All Channels Unsupervised

Figure 2  
Jumpers on VCC2002-A1 voice I/O Card

Channel	Jumper ID	Jumper Position for Supervised Channel	Jumper Position for Unsupervised Channel
Audio Input 1	X401	2-3	1-2
	X400	1-2	2-3
Audio Input 2	X403	2-3	1-2
	X402	1-2	2-3
Audio Output	X601	2-3	1-2
	X600	1-2	2-3

Table 1  
Jumper Settings on VCC2002-A1 Voice-I/O Card for Supervised Channel Operation

**CAUTION:** If supervised audio input lines are to be implemented, ensure that any connected audio equipment is compatible with the 18VDC supervision voltage

**OPERATION**

Please refer to Figure 3.

The primary functions of the VCC2002-A1 Voice I/O Card are to:

- Interface with the VTO2004-U2/U3 Microphone Module and the VTO2001-U2/U3 Option Module (24 Switches).
- Provide analog to digital conversion of announcements routed to the VCC2001-A1 Voice CPU Card
- Provide digital to analog conversion of announcements routed from the VCC2001-A1 Voice CPU Card to external announcement devices.
- Distribute and supervise 24VDC power
- Provide DC supervision of external wiring
- Provide a CAN bus repeater functionality

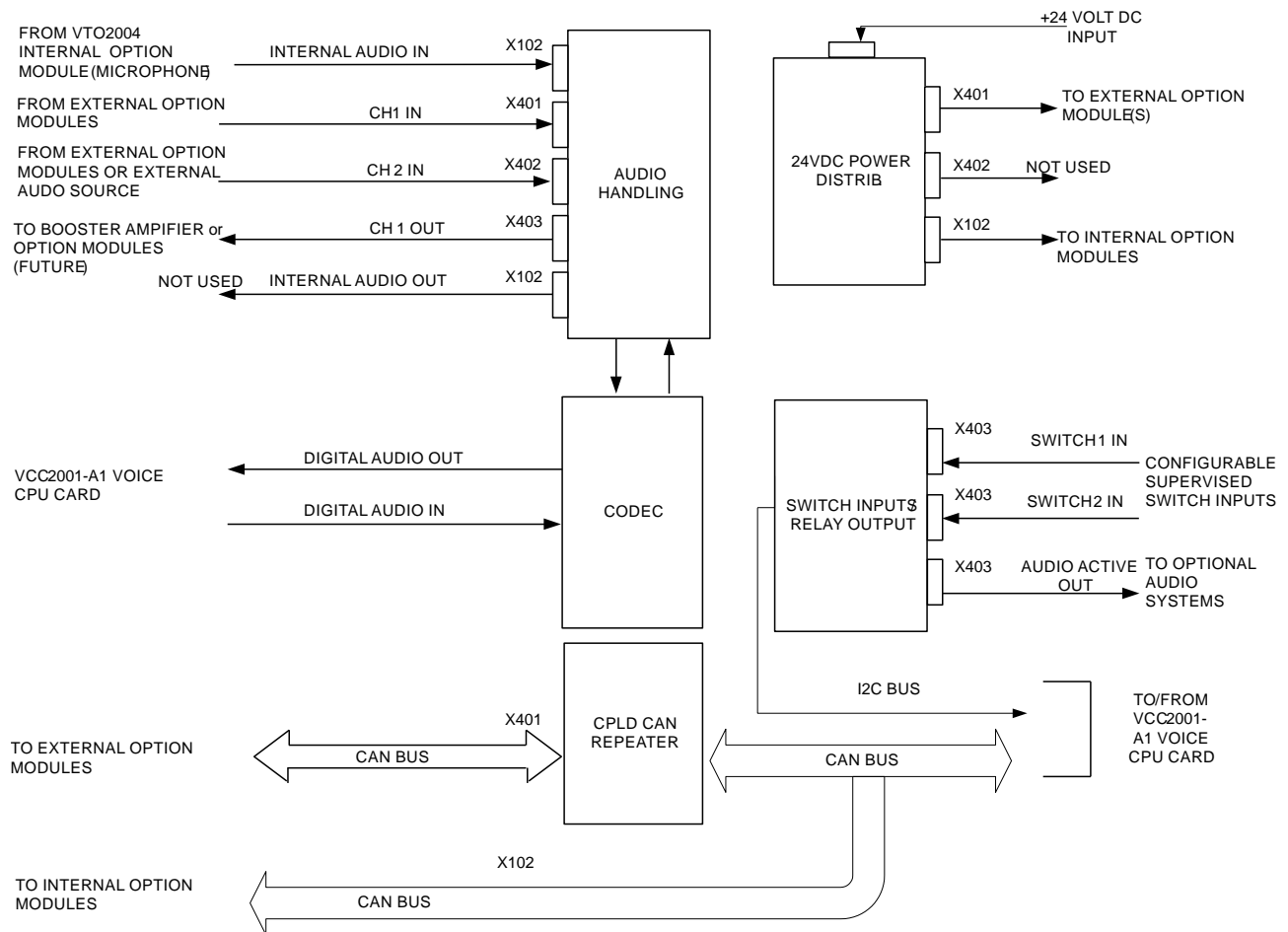

Figure 3  
VCC2002-A1 Voice I/O Card  
Signal Flow Diagram

## Controls and Indicators

The VCC2002-A1 VCC I/O Card contains:

- Eight diagnostic LEDs
- One Power LED

All of these indicators are located along the card edge and visible through the Card Cage front cover.

LED ID	COLOR	NORMAL STATE	ACTIVE STATE	FAULT CONDITION	DESCRIPTION
Input 1 Active	Green	Off	On	—	Channel 1 Active
Input 1 Fault	Yellow	Off	—	On	Channel 1 Fault
Input 2 Active	Green	Off	On	—	Channel 2 Active
Input 2 Fault	Yellow	Off	—	On	Channel 2 Fault
Audio Out Active	Green	Off	On	—	Audio Output Active
Audio Out Fail	Yellow	Off	—	On	Audio Output Fault
24V-CAN Fail	Yellow	Off	—	On	24V or CAN Bus Fault
Card Fail	Yellow	Off	—	On	Card failure
Power	Green	On	—	Off	+3.3VDC Power
Audio Out Fail	Yellow	Off	—	On	Audio Output Fault

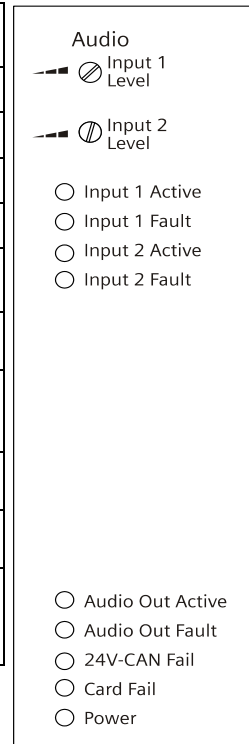

**Table 2: VCC-A1 Indicator LED States and Meaning**

**Figure 4: VCC2002-A1 Indicator LEDs**

## Switch Inputs/Relay Output

Two general purpose contact closure inputs and one relay closure output are available to/from the VCC-I/O card. Either switch input can be used to indicate the presence of an external analog signal on the Channel 2 audio input (if used). The contact closure output is used to indicate that the output audio from the system is active.

**Inputs (switch 1 and switch 2):** A resistive (680Ω) contact closure must be provided by an external audio source. This closure may be connected to either switch input. This will indicate to the system that an analog audio signal is applied to the audio input channel. A closed contact indicates that the audio input to the channel is active while an open contact means that the audio input is inactive. A second set of contacts can be optionally used for other purposes as needed.

**Output:** A relay contact output on the VCC-I/O card closes to indicate to an external device that the audio output is active. When the audio output is active, the relay contact is closed. When there is no audio output the relay contact is open. This is an isolated contact closure. The external connected device must supply its own voltage to monitor the state of the relay contact.

---

## MOUNTING



**Remove electrical power prior to working on equipment.**

To mount the VCC-I/O in the card cage:

1. Open the inner door of the FV2025/2050 Fire Voice Control Panel.
2. Unscrew the latch on the center-bottom of the Card Cage front cover and slide the cover up until it clears the Card Cage assembly.

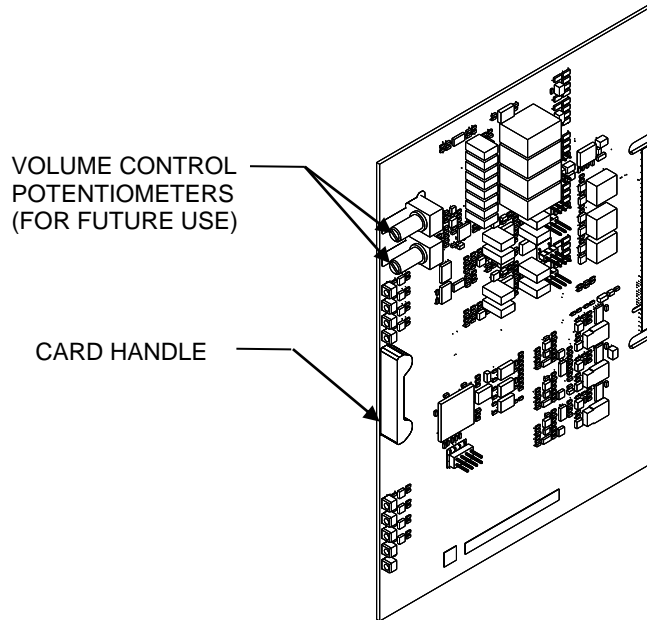

*Figure 5*  
*VCC2002-A1 Voice I/O Card Showing Handle and Volume Controls*

3. Refer to Figure 5. Holding the VCC2002-A1 so the two volume control potentiometers are on top of the card, **gently** insert the card into the backplane connector marked X201 (furthest left position of the card cage). Use the raised channel guides on the inside top and bottom of the Card Cage to guide it into place.

**CAUTION**

**When inserting the VCC2002-A1 into the backplane connector, avoid using the top and bottom of the card cage for leverage. Instead, push gently on the center of the molded plastic card handle until the card snaps into place. Be sure that the card is perpendicular to the front of the Card Cage and is positioned between the two indented metal cards guides in the top and bottom of the Card Cage. The card needs to be between all three sets of card guides as it is slid into place to correctly mate with the backplane connector.**

**WARNING**

**To avoid damaging the VCC2002-A1 card or the backplane connector, DO NOT FORCE THE CARD INTO POSITION.**

4. Replace the Card Cage cover by re-inserting it into the top of the cage and sliding it downward until it reaches the bottom of the assembly.
5. Screw the latch back into the Card Cage cover.

*Removing the Voice I/O Card from the Card Cage*

1. First remove power from the Card Cage.
2. Unscrew the latch on the center-bottom of the VCA2002-A1 Card Cage front cover and slide the cover up.
3. Grip the VCC2001-A1 Card by the molded plastic card handle and pull the card gently out of the backplane connector.
4. Replace the Card Cage cover and reinsert the latch.

## WIRING

All signals to/from option modules or other devices are connected to the VCC-I/O card via Card Cage Connectors X401, X402, X403, and X102 located on the VCA2002-A1 Card Cage. The wiring for these connectors is shown in Table 4 of Siemens Industry, Inc., Building Technologies Division, document number A6V10380472 *Installation Instructions for the Model VCA2002-A1 Card Cage*.

The following tables summarize these connections and are included here for reference.

X401 Pin	Function	Comment
1	24VDC Out Ch1	+24VDC power and return to Remote Modules
2	24VDC Ret Ch1	
3	CAN H Ch1	CAN Bus Connections to Remote Module
4	CAN L Ch1	
5	Earth	
6	Earth	
7	Audio in Ch1 +	Leave empty if remote modules are not used on this line. Otherwise, place a terminating plug at the last remote module. (End of Line Adapter A5Q00055918D)
8	Audio in Ch1 -	

### *Terminating resistors*

Install 3.3K ohm terminating resistors onto terminals of the Voice I/O Card Field Connectors, X402 & X403, which is located on top left of the Card Cage backplane as shown in the following tables

NOTE: Terminating plugs must be located at the end of line when Option Modules are used.

X402 Pin	Function	Terminating Resistor (EOL)	Comment
1	(NOT USED)		
2	(NOT USED)		
3	(NOT USED)		
4	(NOT USED)		
5	Earth		
6	Earth		
7	Audio in Ch2 +	3.3k Ohm C24235-A1-K14	Install an EOL resistor if remote modules are not used. Remove the EOL resistor if remote modules are used and place a
8	Audio in Ch2 -		

			terminating plug at the last remote module. (End of Line Adapter A5Q00055918D)
--	--	--	---

<b>X403 Pin</b>	<b>Function</b>	<b>Terminating Resistor*</b>	<b>Comment</b>
1	Audio Out+	3.3K Ohm	Install an EOL resistor on X403 if not connected to an external device. The EOL resistor must be moved to the end of line when supervision is used.
2	Audio Out-	C24235-A1-K14	
3	Audio Out Active Ch1+		
4	Audio Out Active Ch1-		
5	Switch 1 Input +	3.3K Ohm	Install an EOL resistor on X403 if not connected to an external device. The EOL resistor must be moved to the end of line when this input is used.
6	Switch 1 Input -	C24235-A1-K14	
7	Switch 2 Input +	3.3K Ohm	Install an EOL resistor on X403 if not connected to an external device. The EOL resistor must be moved to the end of line when this input is used.
8	Switch 2 Input -	C24235-A1-K14	
9	External Alarm+	3.3K Ohm	
10	External Alarm-	C24235-A1-K14	

\*All terminating resistors are provided in the A5Q00056088 Accessory Kit furnished with the VCA2002-A1 Card Cage.

<b>X102</b>	<b>Function</b>	<b>Terminating Resistor (EOL)</b>	<b>Comment</b>
	Local Option Module Connector	EOL Terminating Plug (End of Line Adapter) A5Q00055918D	Install the EOL Adapter on X102 if no internal Option Module(s) are used. The EOL adapter must be moved to the last internal Option Module when equipped.



---

**ELECTRICAL RATINGS**

VCC2002-A1 Voice I/O Card		
Card Input	Voltage	24VDC, 3.3 VDC
	Current	151 mA (Standby) 156 mA (Active)
Output 1 (X401 on Card Cage)	Voltage	24VDC
	Current	4A, max*
Output 2 (X402 on Card Cage)	Voltage	24VDC
	Current	4A, max*

**\*NOTE:** The 4A is shared between X401 and X402. The maximum combined load for both outputs must not exceed 4A when connecting devices on X401 and X402.

## Cyber security disclaimer

Siemens provides a portfolio of products, solutions, systems and services that includes security functions that support the secure operation of plants, systems, machines and networks. In the field of Building Technologies, this includes building automation and control, fire safety, security management as well as physical security systems.

In order to protect plants, systems, machines and networks against cyber threats, it is necessary to implement – and continuously maintain – a holistic, state-of-the-art security concept. Siemens' portfolio only forms one element of such a concept. You are responsible for preventing unauthorized access to your plants, systems, machines and networks which should only be connected to an enterprise network or the internet if and to the extent such a connection is necessary and only when appropriate security measures (e.g. firewalls and/or network segmentation) are in place. Additionally, Siemens' guidance on appropriate security measures should be taken into account. For additional information, please contact your Siemens sales representative or visit <https://www.siemens.com/global/en/home/company/topicareas/future-of-manufacturing/industrial-security.html>.

Siemens' portfolio undergoes continuous development to make it more secure. Siemens strongly recommends that updates are applied as soon as they are available and that the latest versions are used. Use of versions that are no longer supported, and failure to apply the latest updates may increase your exposure to cyber threats. Siemens strongly recommends to comply with security advisories on the latest security threats, patches and other related measures, published, among others, under <https://www.siemens.com/cert/en/cert-security-advisories.htm>.