

# Catalog Number: JA0816B1350RLTM

## Features and Ratings

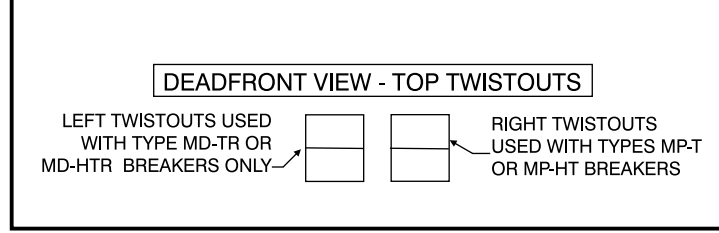

- Outdoor Enclosure (NEMA Type 3R)
- Ringless Type Meter Cover
- Device Rating: 400A Max
- 120/240V~ 1 Phase, 3 Wire ; 120/208V~ 1 Phase, 3 Wire w/5th Jaw Installed
- Meter Socket Rating: 400A (320A Continuous)
- 4 Jaw, Lever Operated Bypass with Jaw Tension Release
- 150A Main Breaker Factory Installed
- (8) 1" Spaces, (16) Circuits Max.
- Feed-Thru Terminals
- 22,000 AIC Max. Rated (See Wiring Diagram for Details)
- UL Listed only for use as Service Entrance Equipment
- Overhead or Underground Service Entrance
- Surface Mounting



## Accessories

- ACCESSORIES**
- FILLER PLATE . . . . . ECQF3
  - 5TH JAW SHIELD . . . H35815-2
- FOR HUB, ORDER FROM "HD" SERIES
- COVERPLATE . . . . . EC56933S
  - 3" HUB . . . . . EC56856
  - 3 1/2" HUB . . . . . EC56857
  - 4" HUB . . . . . EC56858

**HARDWARE TIGHTENING TORQUES:**

3/8" NUTS . . . . . 250-300 LB.-IN.

## Schematic

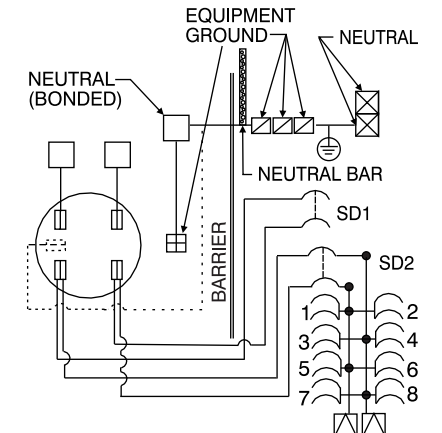

TERMINAL RANGES	TORQUE
kcmil OR AWG; CU/AL	LB.-IN.
□ (1)600kcmil-#4 OR (2)350kcmil-1/0	500
□ Alt. Lugs H56732-2 (2) 350kcmil-#4	500
□ (1)2/0-#12	50
⊠ (1)250kcmil-4	250
⊠ (1)2/0-#6	275
⊠ (1)250kcmil - 4	275
<b>NEUTRAL BAR TERMINALS</b>	
SMALL (1) #10-#14	20
(1) #8	25
(1) #6	35
LARGE (1) #10-14	35
(1) #8	40
(1) 1/0 - #6	45

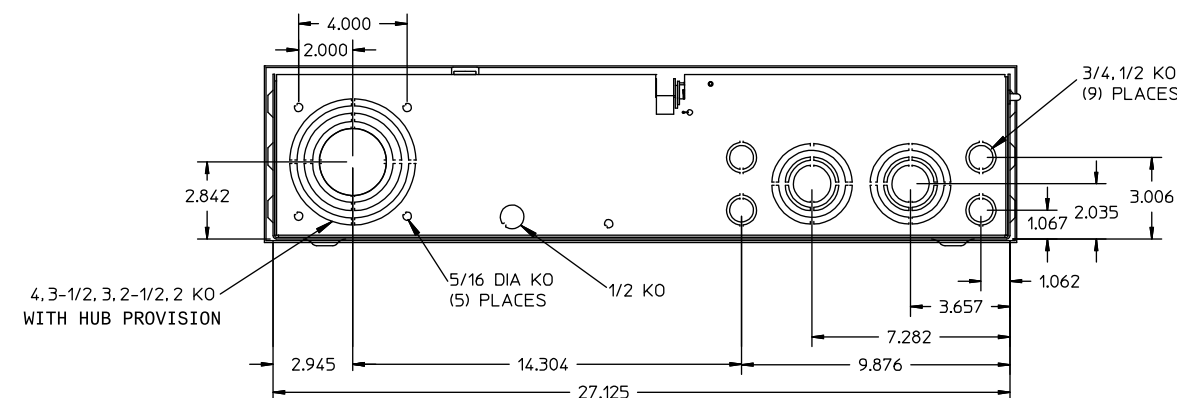
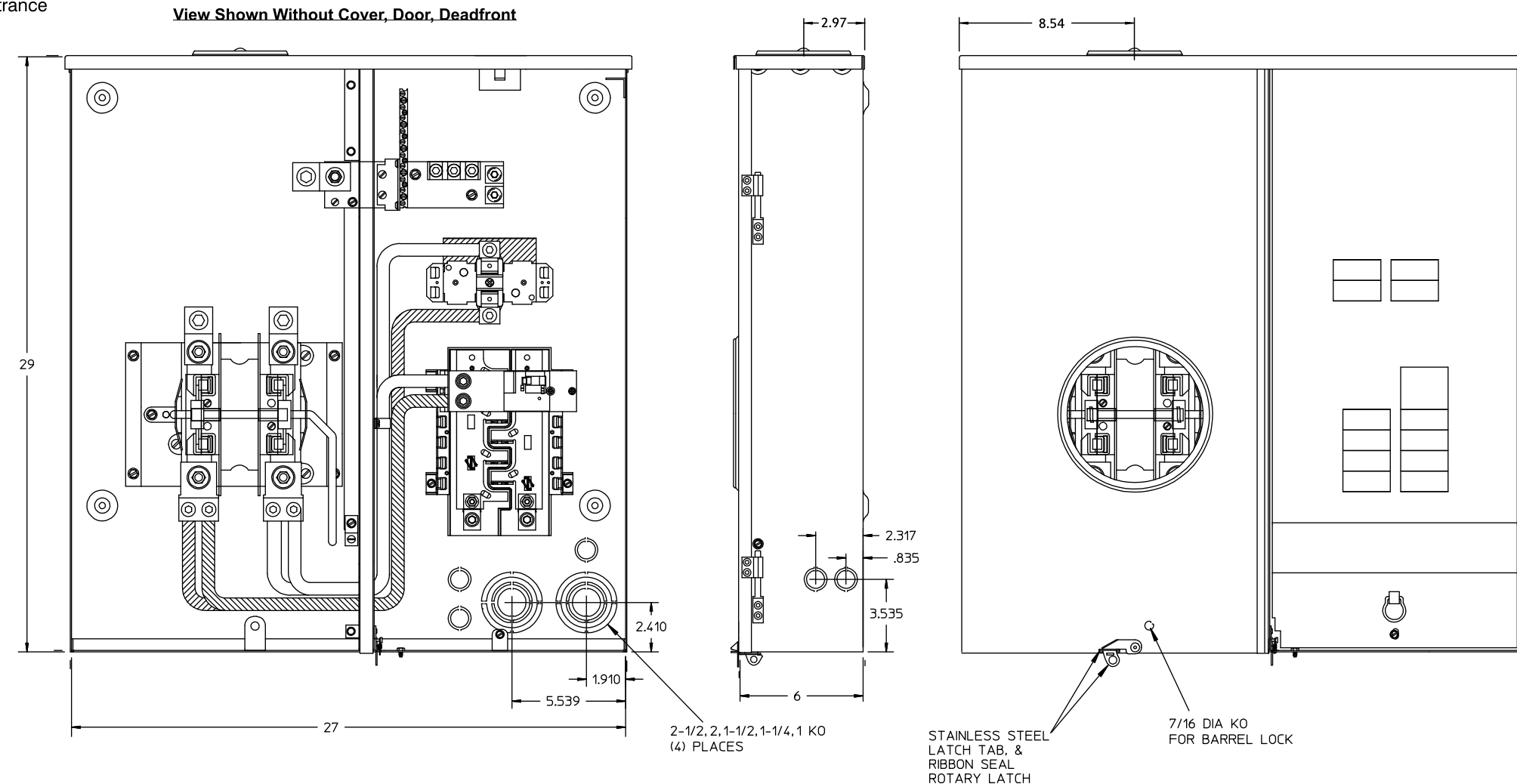

## Meter Load Center Combination

Description:

**400A, 1ph, 16 Ckt Max, RL, 150A MB, OH/UG**

KAM 7/8/14 Fam M DO NOT SCALE DRAWING Dwg. No. **JA0816B1350RLTM**