



ClearMark Advanced II Printer

Catalog Number 1492-PCMA2110



Allen-Bradley

by ROCKWELL AUTOMATION

User Manual

Original Instructions

Important User Information

Read this document and the documents listed in the additional resources section about installation, configuration, and operation of this equipment before you install, configure, operate, or maintain this product. Users are required to familiarize themselves with installation and wiring instructions in addition to requirements of all applicable codes, laws, and standards.

Activities including installation, adjustments, putting into service, use, assembly, disassembly, and maintenance are required to be carried out by suitably trained personnel in accordance with applicable code of practice.

If this equipment is used in a manner not specified by the manufacturer, the protection provided by the equipment may be impaired.

In no event will Rockwell Automation, Inc. be responsible or liable for indirect or consequential damages resulting from the use or application of this equipment.

The examples and diagrams in this manual are included solely for illustrative purposes. Because of the many variables and requirements associated with any particular installation, Rockwell Automation, Inc. cannot assume responsibility or liability for actual use based on the examples and diagrams.

No patent liability is assumed by Rockwell Automation, Inc. with respect to use of information, circuits, equipment, or software described in this manual.

Reproduction of the contents of this manual, in whole or in part, without written permission of Rockwell Automation, Inc., is prohibited.

Throughout this manual, when necessary, we use notes to make you aware of safety considerations.



WARNING: Identifies information about practices or circumstances that can cause an explosion in a hazardous environment, which may lead to personal injury or death, property damage, or economic loss.



ATTENTION: Identifies information about practices or circumstances that can lead to personal injury or death, property damage, or economic loss. Attentions help you identify a hazard, avoid a hazard, and recognize the consequence.

IMPORTANT Identifies information that is critical for successful application and understanding of the product.

These labels may also be on or inside the equipment to provide specific precautions.



SHOCK HAZARD: Labels may be on or inside the equipment, for example, a drive or motor, to alert people that dangerous voltage may be present.



BURN HAZARD: Labels may be on or inside the equipment, for example, a drive or motor, to alert people that surfaces may reach dangerous temperatures.



ARC FLASH HAZARD: Labels may be on or inside the equipment, for example, a motor control center, to alert people to potential Arc Flash. Arc Flash will cause severe injury or death. Wear proper Personal Protective Equipment (PPE). Follow ALL Regulatory requirements for safe work practices and for Personal Protective Equipment (PPE).

The following icon may appear in the text of this document.



Identifies information that is useful and can help to make a process easier to do or easier to understand.

Rockwell Automation recognizes that some of the terms that are currently used in our industry and in this publication are not in alignment with the movement toward inclusive language in technology. We are proactively collaborating with industry peers to find alternatives to such terms and making changes to our products and content. Please excuse the use of such terms in our content while we implement these changes.

	Preface	
	About This Publication	5
	Summary of Changes	5
	Warranty and Liability	5
	Copyright	5
	Safety Information	5
	General Operating Information	6
	Handling Ink and Fluid Cartridges	6
	Symbols and Information Used on the Device	7
	Intended Use	7
	Residual Risks When Using the Device	8
	Hazards Due to Electricity	8
	Hazards Due to Hot Surfaces	9
	Hazards Due to Use of Incorrect Spare Parts	9
	Personnel Requirements	9
	Additional Resources	9
	Chapter 1	
Printer Description	Printer Components	11
	Touch Panel Components	12
	Bulletin 1492 Marker Cards	15
	Chapter 2	
Printer Installation	Unpack the Printer	17
	Scope of supply	18
	Install the Printer	18
	Extract the Output Tray	19
	Align the Touch Panel	20
	Connect the Printer to the PC	20
	Create a Wired Connection	20
	Turn the Printer On	21
	Turn the Printer Off (Switch the Printer to Standby Mode)	21
	Insert an Ink Cartridge	22
	Chapter 3	
Software Installation	Install the ClearTools Software	25
	Install the Printer and Drivers	27
	Connect to a Computer	27
	USB Installation	27
	Set up a Marker Card for the Printer	29
	Run a Print Test	29
	Chapter 4	
Operations	Activate Longer Downtime Mode	31

	Restore Operational Readiness of the Printer.	32
	Shelf Life of the Ink	33
	Insert Marker Cards	33
	Process a Stack of Marker Cards	33
	Print a Marker Card.	34
	Determine Curing Settings and Heating Levels.	34
	Select the Print Quality.	34
	Settings on the Touch Panel	34
	System status	35
	Current Jobs	35
	Print job history	36
	Demo print jobs.	36
	Interfaces / USB Connection.	36
	Advanced Settings / Printer	37
	System Information	37
	Chapter 5	
Cleaning and Maintenance	Software-controlled Maintenance	39
	Perform a Nozzle Check.	39
	Clean the Print Head Automatically	40
	Clean the Print Head Manually.	41
	Replace Ink Cartridges and Fluid Cartridges.	42
	Replace the Ink Collector.	44
	Clean the Printer Enclosure and Touch Panel.	45
	Chapter 6	
Troubleshooting	General Information	47
	Marker Card Left in Turned-off Device.	47
	Messages on the Touch Panel.	47
	Troubleshooting List.	48
	Chapter 7	
Technical Data	Printer Specifications	49
	Chapter 8	
Service Parts and Accessories	Replacement Parts.	51
	Chapter 9	
Decommissioning the Printer	Set Longer Downtime Mode.	53
	Pack and Transport the Printer	53
	Appendix A	
Cleaning Unit Replacement	Remove the Cleaning Unit	55
	Install the Cleaning Unit.	56

About This Publication

This publication provides instructions on how to use the ClearMark™ Advanced II ink-jet printer, which, together with the ClearTools™ software, is a marking system for Bulletin 1492 marker cards. This publication is intended for users who operate and maintain the printer.

Summary of Changes

This publication contains new and updated information as indicated in the following table.

Topic	Page
Updated revision letter for replacement parts on table 15	51

Warranty and Liability

The obligations specified in the supply contract, the general and delivery terms and conditions of Rockwell Automation, and the legal regulations in force at the time the contract is signed.

All information and instructions in this user manual are compiled in line with applicable standards and regulations, state-of-the-art technology, and our extensive knowledge and experience.

Warranty and liability claims for personal injury and material damage are excluded if they are attributable to one or more of the following causes:

- Unintended or inappropriate use of the printer (see [Intended Use on page 7](#)).
- Inappropriate installation, commissioning, operation, maintenance, and cleaning of the printer.
- Operation of the printer with a defective or incorrectly fitted printer enclosure.
- Non-compliance with the user manual.
- Deployment of non-instructed personnel.
- Structural alterations to the printer (modifications or other alterations to the printer are prohibited. Non-compliance results in the printer's EC Declaration of Conformity no longer being valid).
- Technical modifications.
- Opening the printer enclosure.
- Use of out-of-date ink cartridges.
- Use of unapproved spare parts or spare parts that do not satisfy technical requirements.
- Disasters, effects of extraneous elements, and force majeure. We reserve the right to make technical alterations in the course of further development and improvement of features.

Copyright

This user manual is protected by copyright and is intended for internal use only. Without the written consent of Rockwell Automation, any use outside the limits of copyright law is prohibited. This applies in particular to copies and translations. Contravention results in liability for damages. Further claims remain reserved.

Safety Information



WARNING: Risk to persons due to electrical and chemical hazards.

- Read the safety and hazard information in this chapter before putting the printer into operation.
- And the information in this user manual, observe the applicable national work, operating, and safety regulations.
- Observe the applicable internal company regulations.

In the following cases, you must disconnect the printer from all sources of power and contact a qualified service technician:

- The power cable or plug is worn or damaged.
- Liquid has entered the printer.
- The printer has fallen, or the enclosure has been damaged.
- The performance of the printer is not up to the required standard, for example, poor print quality or insufficient resistance to smearing and scratching.



WARNING: Danger of injury when the printer is open!

Using the printer when it is open can result in cuts and crushing injuries.

- Never remove the printer enclosure.
 - Components inside the device must be replaced by a Rockwell Automation service technician.
-

IMPORTANT Device damage!

The printer enclosure must not be removed. Opening the printer results in the loss of any warranty rights.

In addition to the preceding cautions and warnings, observe the following guidelines:

- Make sure that all persons who work on the device have fully read and understood the user manual.
- Only use the printer for its intended purpose (see [Intended Use on page 7](#)).
- Keep all safety information and warnings on the printer clean and legible; replace them, if necessary.
- Only instructed personnel must work on the device.
- To ensure that everyone who uses the device is able to view the user manual at any time, always keep the user manual with the product for future reference.

General Operating Information

Consider the following guidelines as you operate the printer:

- When selecting the installation site for the printer, make sure that the ambient conditions are suitable (see [Technical Data on page 49](#)).
- Make sure that openings in the printer enclosure are not blocked or covered.
- Do not turn off the printer! The printer automatically switches to standby mode. The operating parameters are only retained while the printer is turned on. These parameters ensure, for example, that the print head is cleaned optimally.
- Keep the ink tank lid closed during operation.

IMPORTANT Use only Rockwell Automation products.

Use only products that are produced or approved by Rockwell Automation (ClearTools marking software, marker cards, and ink cartridges).

Poor print quality, printer faults, and damage caused by using unapproved and unsuitable accessories and printing materials are excluded from the warranty.

Handling Ink and Fluid Cartridges

To ensure that users handle ink and fluid cartridges properly, follow these guidelines:

- Keep ink and fluid cartridges out of the reach of children.
- The ink and fluid are not suitable for consumption. Do not allow ink to come into contact with the mucous membranes. If you accidentally swallow any ink, rinse your mouth and drink plenty of water. Do not induce vomiting.
- Always handle ink and fluid cartridges with care. Otherwise ink or fluid can spill and cause soiling.

- Always handle used ink and fluid cartridges with care, as a small amount of ink or fluid can remain in the supply outlet. If you get ink or fluid on your skin, wash thoroughly with soap and water.
- Never touch the ink or fluid cartridge supply outlet or the area of the supply outlet.
- Do not shake ink or fluid cartridges, as this action may cause ink or fluid to leak.
- Do not disassemble or try to refill ink or fluid cartridges.
- Store unopened ink or fluid cartridges in a cool and dry place, preferably in a refrigerator at approximately 4 °C (39.2 °F). Allow cooled ink or fluid cartridges to warm to room temperature for at least three hours before use.
- Remove ink cartridges from the printer only when they are empty or out of date.
- Do not use out-of-date ink cartridges.
- When the use-by date of the ink approaches (printed on the packaging), the touch panel displays a message. Use all ink in the ink cartridge by the date stated on the label to achieve the best print results.





IMPORTANT **Damage to the device due to old ink!**

Using out-of-date ink may damage the printer.

Symbols and Information Used on the Device

The following information and symbols are attached to the printer:

Table 1 - Warning Symbols

Symbol	Description
	Warning of crush hazard. This symbol warns of a crush hazard, for instance, to your hands.
	Warning of hot surface. This symbol warns of a burn hazard due to hot surfaces.
	Warning of automatic startup. This symbol warns of automatic printer startup.
	Warning of sharp objects. This symbol warns of potential hand injuries due to sharp objects.

The following warning label appears on the device.

Achtung: Gerät nicht öffnen !	Attention: Do not open the printer !
Verletzungsgefahr ! Es gibt keine zu wartenden Teile im Inneren des Gerätes. Durch Öffnen verlieren Sie alle Garantieansprüche.	Risk of injury ! There are no serviceable parts inside the housing. Opening will cause loss of any warranty rights.
<ul style="list-style-type: none"> • Apparatets stikprop skal tilsluttes en stikkontakt med jord, som giver forbindelse til stikproppens jord. • Apparatet skall anslutas till jordat uttag. • Apparatet må tilkoples jordet stikkontakt. • Laite on liitettävä suojakoskettimilla varustettuun pistorasiaan. 	

IMPORTANT Keep all safety information and warnings on the device clean and legible; replace them, if necessary.

Intended Use

In conjunction with the ClearTools software, the printer is designed for marking Bulletin 1492 marker cards in commercial and industrial applications.

Any other use is prohibited. Using the printer in unapproved applications immediately leads to the expiration of all guarantee and warranty claims on the part of the operator against the manufacturer.

Using the printer for purposes other than those specified, or failure to observe the operating instructions and warnings, can lead to serious malfunctioning, personal injury, or damage to property.

Only use the ClearTools software, marker cards, and inks that are approved for this marking system by Rockwell Automation.

Rockwell Automation can make no guarantee for the print quality and resistance when a different marking software and other printing materials and ink are used.

Claims of any kind for personal injury or material damage that arise from unintended use are ruled out. The plant operator alone is liable for any injury or damage attributable to unintended use.

Intended use also includes:

- Heeding all information in the user manual.
- Complying with the operating and maintenance conditions.

Never modify the printer. Non-compliance invalidates the printer's EC Declaration of Conformity. Such a breach absolves the manufacturer of the printer from warranty. Have any defective components of the printer replaced immediately by a Rockwell Automation service technician.

Residual Risks When Using the Device

The device has a state-of-the-art design and complies with recognized safety rules and regulations. However, impairments can still arise when using the device. Only use the device for its intended purpose. When using the device, observe the warnings on the device and the safety information in this user manual.

Hazards Due to Electricity



WARNING: Warning of electrical hazard!

Touching live parts is a direct risk to life. Damage to the insulation or individual components may result in fatal injury.

- Work on the electrical components of the printer may only be carried out by electrical specialists.
 - Only connect the device to a properly grounded and fused socket.
 - Do not connect the printer to either a switch-operated or a timer-controlled socket.
 - Never use damaged power cables.
 - Regularly inspect the electrical components of the printer for defects, such as loose connections or damage to the insulation.
 - If damage is detected, immediately switch off the power supply to the printer and have the damage repaired.
 - Have all connecting cables and plugs inspected by an electrical specialist at least every 6 months!
 - Never bypass fuses and never take them out of operation.
 - When replacing fuses, pay attention to the correct amperage.
 - When connecting an extension cable to the printer, make sure that the rated current value does not exceed the ampere rating of the extension cable.
 - Keep moisture away from live parts as it can cause short circuits. Pay particular attention to this situation when cleaning the printer.
-

Hazards Due to Hot Surfaces



WARNING: Burn hazard due to hot surfaces!

Contact with hot components and cards may cause burns. Make sure that all components have cooled down to the ambient temperature before conducting any service or maintenance work.

Hazards Due to Use of Incorrect Spare Parts

IMPORTANT Damage due to incorrect or faulty spare parts!

Incorrect or faulty spare parts may cause damage, malfunctions, or total failure. Use original spare parts only.

Obtain the spare parts from Rockwell Automation. For information about spare parts, see [Service Parts and Accessories on page 51](#).

The printer is equipped with the following safety features:

- Ink tank lid
- Service flap (ink collector)
- Main Plugs

IMPORTANT The printer must not be operated without the printer enclosure. The printer enclosure must not be removed. Only operate the printer with the ink tank lid closed.

Personnel Requirements

Only trained personnel must operate the printer and perform maintenance tasks. In addition, personnel must follow the instructions in this user manual.

IMPORTANT Repairs may only be conducted after consultation with Rockwell Automation and only by an electrical specialist.

The responsibilities of personnel for commissioning, operating, maintaining, and cleaning must be clearly defined. Personnel require the following qualifications for the various activities:

- Trained skilled personnel can do their work and recognize/avoid potential hazards on their own because of their training, knowledge, experience, and familiarity with the relevant regulations.
- Electrical specialists can work independently on electrical devices and recognize/avoid potential hazards because of their training, knowledge, experience, and familiarity with the relevant standards and regulations. Electrical specialists have been trained for their specific task and know the relevant standards and regulations.

Additional Resources

These documents contain additional information concerning related products from Rockwell Automation.

Resource	Description
Industrial Automation Wiring and Grounding Guidelines, publication 1770-4.1	Provides general guidelines for installing a Rockwell Automation industrial system.
Product Certifications website, rok.auto/certifications .	Provides declarations of conformity, certificates, and other certification details.
System Security Design Guidelines Reference Manual, publication SECURE-RM001 .	Provides cybersecurity guidelines for the installation, configuration, and operation of industrial control systems.

You can view or download publications at rok.auto/literature.

Notes:

Printer Description

Combined with the ClearTools™ software, the ClearMark™ Advanced II ink-jet printer is a marking system for Bulletin 1492 marker cards. Individual equipment can be marked with the marking system. The printer labels markers in marker card format for switchgear, automatic machines, terminal blocks, cables, lines, and valves. The ClearMark Advanced II printer allows you to print very small fonts. Even the smallest characters are easy to read, which allows you to increase the density of information placed on the markers. The marker cards can be fed into the input tray (loader) individually or inserted as a stack of up to 50 cards. The marker cards that are fed into the printing unit are printed with a thermally hardened ink and then transferred to a curing unit. In the curing unit, the ink is hardened with a special heat radiator. Marker cards are fed into the output tray where they can then be removed and used immediately.

IMPORTANT The marker cards become hot due to the curing process. If necessary, let them cool down before removing them from the output tray.

Printer Components

Figure 1 - ClearMark Advanced II Printer – Top View

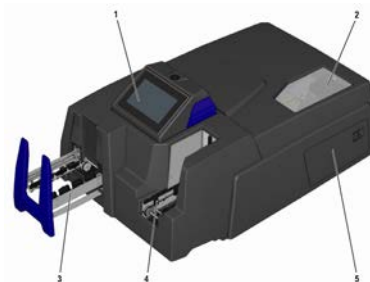

Item	Description
1	Touch panel
2	Ink tank lid
3	Output tray
4	Input tray (loader)
5	Service flap (for maintenance by user)

Figure 2 - ClearMark Advanced II Printer – Back View



Item	Description
1	Connectors
2	Service cover (for maintenance by service staff)

Figure 3 - ClearMark Advanced II Printer – Ink Tank Compartment

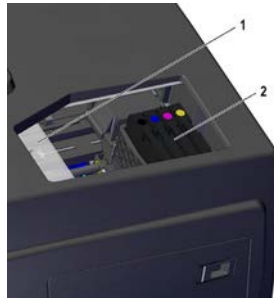

Item	Description
1	Ink tank lid (open)
2	Ink cartridges

Figure 4 - ClearMark Advanced II Printer – Back View Enlarged



Item	Description
1	USB-B connector printer/PC
2	Main switch with connection for main plug (115/230 V)
3	Fuse (type: 10 AHT)

Touch Panel Components

For a description of the elements that appear on the touch panel and its menus and submenus, see [Table 2...Table 6](#).

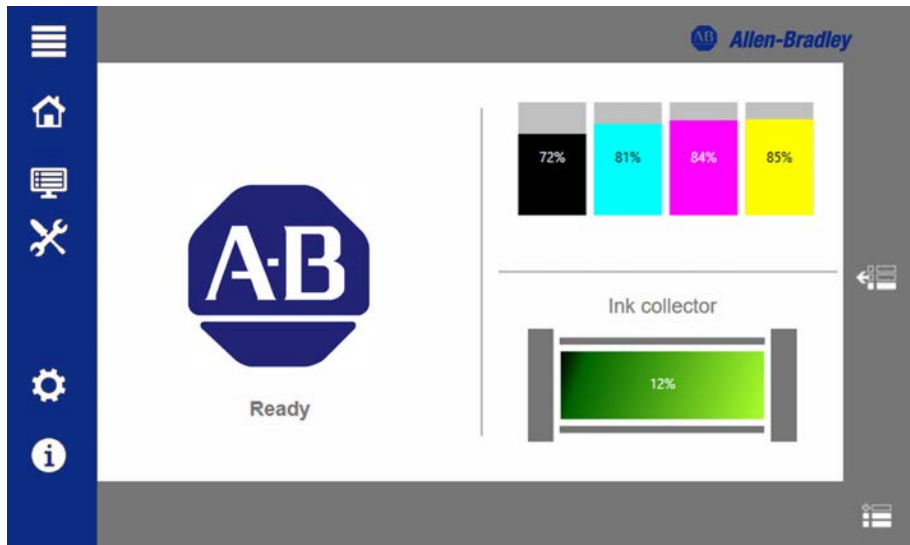

Table 2 - Icons and Functions on the Main Menu

Icon	Name	Description
	Main menu	Expands the symbol view with the names of the main menus.
	System status	Displays the current printer status: Readiness, fill level of the ink cartridges and the ink collector.
	Jobs	Shows the available submenus: Current jobs, print job history, and demo print jobs.

Table 2 - Icons and Functions on the Main Menu (Continued)



Icon	Name	Description
	Maintenance	Shows the available submenus: Print head cleaning, nozzle check, and longer downtime.
	Settings	Shows the available submenus: Interfaces and advanced settings.
	Information	Shows the available submenu: System information.

Table 3 - Icons and Functions on the Jobs Menu



Icon	Name	Description
	Current jobs	Displays the current print jobs, along with the following information: Number—Sequence number of the current print jobs Marker type—Card type Quantity—Quantity of cards Status—Processing status In process—The print job is being executed Wait—The print job is executed as soon as the current print job has been completed.
	Print job history	Displays the completed print jobs with information about the card type used.
	Demo print jobs	Displays examples that can be executed as a print job.

Table 4 - Icons and Functions on the Maintenance Menu



Icon	Name	Description
	Print head cleaning	Allows you to configure and execute print head cleaning.
	Nozzle check	Allows you to initiate a nozzle check to check the correct functioning of the nozzles.
	Longer downtime	Allows you to set the printer to an operating mode for longer downtimes. All ink-carrying components are filled with fluid after replacing the ink cartridges with fluid cartridges. This ensures that the ink-carrying components are not clogged with dried ink when the printer is turned off.

Table 5 - Icons and Functions on the Settings Menu



Icon	Name	Description
	Interfaces	Allows you to configure communication between the printer and the PC.
	Advanced settings	Allows you to adjust security-relevant settings for communication and print jobs.

Table 6 - Icons and Functions on the Interfaces Submenu























Icon	Name	Description
	USB connection	Allows you to configure communication between the printer and the PC. For more details, see the ClearTools help.

Table 7 - Icons and Functions on the Information Menu

Icon	Name	Description
	System information	Displays information on the following categories: <ul style="list-style-type: none"> • Ink fill level and shelf life of the ink cartridges • Fill level of the ink collector • Individual characteristics (data) of the printer • Version number of the current firmware • Current ambient conditions (temperature, humidity, voltage supply)

[Table 8](#) describes the buttons and functions that appear on the Printer menu.

Table 8 - Buttons and Functions on the Printer Menu

Icon	Name	Description
	Confirm	Confirms the selected user level. Opens the window with information about the fill level of the ink cartridges and the ink collector.
	Discard	Discards any changes that are made by the user.
	Show help	Shows the help for the corresponding function.
	Close help	Closes the current page of the help.
	Start animation	Starts an animation for service work.
	Print	Prints the displayed print job again.
	Scroll backward	Scrolls backward in the list.
	Scroll forward	Scrolls forward in the list.
	Move up	Moves up the selected print job.
	Move down	Moves down the selected print job.
	Delete individual	Deletes the marked print jobs.
	Delete all	Deletes all print jobs.
	Clean	Executes the configured print head cleaning.
	Save	Saves the setting.
	Show print jobs	Shows the current print jobs.
	Show trouble list	Shows the list with fault or service messages if more than one message has been issued.
	Checkbox activated	Indicates that a function is selected.
	Checkbox deactivated	Indicates that a function is not selected.
	Print head cleaning	Selects the Black and Cyan nozzles for print head cleaning.
		Selects the Magenta and Yellow nozzles for print head cleaning.

Bulletin 1492 Marker Cards

Marker cards that are made of plastic can be printed with the ClearMark Advanced II printer. The marking system, which consists of the ClearMark Advanced II printer and the ClearTools software, is designed by Rockwell Automation for Bulletin 1492 marker cards. When you use these marker cards, keep the following points in mind:

- Marker cards can be inserted individually or in stacks.
- Marker cards can be broken in half. To do this, bend the card in the middle.
- Complete and half marker cards must not be mixed in a stack. It is, however, possible to process different marker card types in a stack, for example, catalog numbers 1492-M5X5, 1492-M5X12, and 1492-M6X10.

Figure 5 - Bulletin 1492 Marker Cards

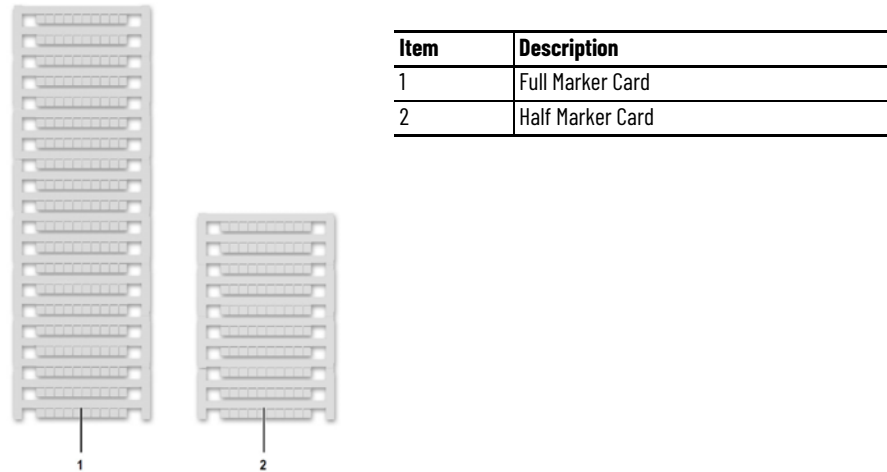

[Figure 6](#) describes the components of a Bulletin 1492 marker card.

Figure 6 - Bulletin 1492 Marker Card Description

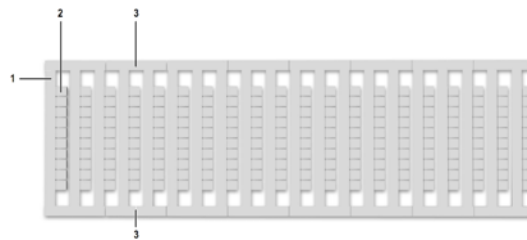

Item	Description
1	First project marker surface
2	Marker area
3	Side strip

Notes:

Printer Installation

Unpack the Printer

This chapter describes the steps you need to take to set up the ClearMark™ Advanced II printer and begin the initial operation.

**WARNING: Crush hazard during transport!**

The printer is heavy and must be transported by two people. Always hold the printer at the front and rear when transporting it.

IMPORTANT

For safety and security reasons, the ClearMark Advanced II printer must be located in an area that is accessible only by authorized printer users.

IMPORTANT Damage to property!

If the printer is transported improperly, the ink may leak and soil or damage the device. Always transport the printer in a horizontal position.

To unpack the printer, complete the following steps:

1. Open the transport packaging.
2. Take out all the accessories.
3. Take out the printer.

IMPORTANT

Two people must lift the printer with the polystyrene packaging material out of the box.

4. Remove the polystyrene packaging material.

IMPORTANT

Keep the original packaging material for any future transport.

5. Remove the transport restraint (1) from the ink tank lid.



6. Check for any damage.
7. Verify that you have all items that are listed in [Table 9](#).
8. Familiarize yourself with the printer (see [Printer Components on page 11](#) and [Touch Panel Components on page 12](#)).

Scope of supply

After you take the printer and all the accessories out of the packaging, make sure that all items listed in [Table 9](#) are included.

Table 9 - What's Included

Cat. No.	Description	Quantity
1492-PCMA2110	ClearMark Advanced II Marking System	1
	Power Cables (North American, European + China)	2
	Unit/box (5 cards inside) Marker Card, 1492-M5X5	1
	Cleaner tissues 1492-PCMACLEANER Ser A, PN-505642	2
	ClearMark Advanced II Printer Quick Start, publication 1492-0S007A	1
	DVD with ClearTools™ Software and Documentation (user manuals)	1
	USB Cable	1

IMPORTANT The ink cartridges are supplied separately and are not installed in the printer. The printer is flushed with fluid.

Install the Printer

IMPORTANT **Damage to property!**

Do not use the printer near potential electromagnetic interference fields, such as speakers or base stations of cordless phones. They can negatively affect correct functionality of the printer.

Place the printer on a flat, stable surface. The printer does not operate properly if it is tilted or at an angle.

Avoid locations where the printer is exposed to great fluctuations in temperature and humidity, direct sunlight, strong exposure to light, excessive heat, and high dust levels.

Avoid locations that are subject to impact shocks or vibrations. Avoid transmission of vibrations.

IMPORTANT Observe the necessary operating and maintenance minimum distances.

To install the printer, complete the following steps:

1. Place the printer on a surface that extends beyond the base area of the printer on all sides.
2. Leave enough space in front of the output rail of the printer.

- Ensure a sufficient supply of air around the printer, as shown in the following illustration.

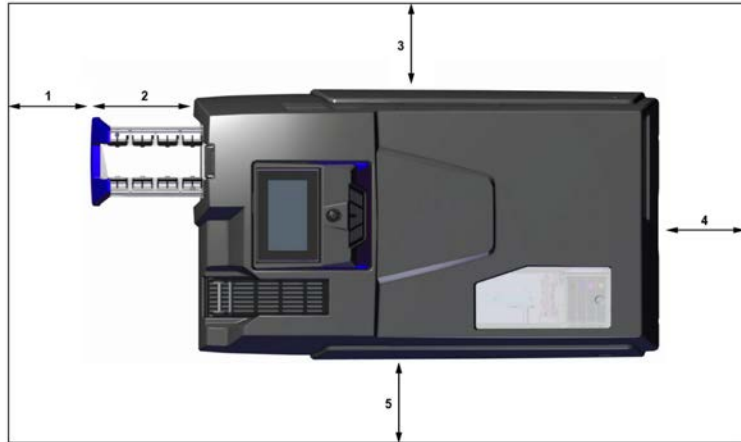

Item	Minimum Space Requirement	Item	Device Dimensions
1	250 mm (9.84 in.)	Length (excluding output tray)	930 mm (36.61 in.)
2	203 mm (7.99 in.) output rail	Width	590 mm (23.23 in.)
3	100 mm (3.94 in.)	Height	454 mm (17.87 in.)
4	100 mm (3.94 in.)		
5	100 mm (3.94 in.)		

Extract the Output Tray

To extract the output tray, complete the following steps:

- Pull out the output tray (1) until it clicks into place.

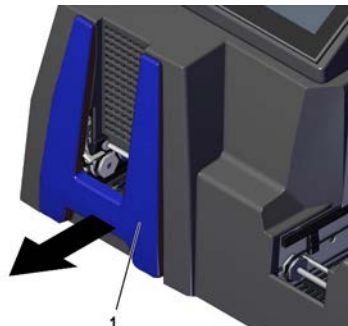

- Fold down the lifting units fully (in two locking steps).

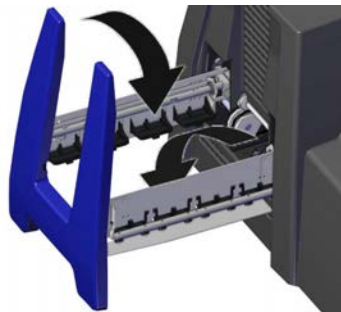

Align the Touch Panel

You can align the touch panel (1) in three positions to suit your preference.

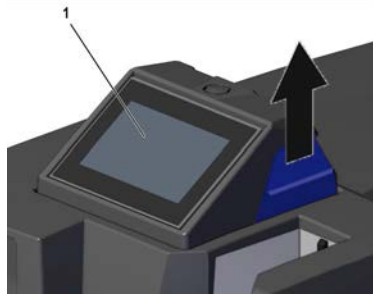

In addition to moving the touch panel up, you can also turn it 90° to the left or right and then let it click into place.

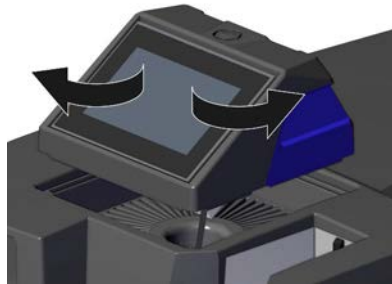

Connect the Printer to the PC

Before you connect the printer to the PC, make sure that you observe the following warnings.



WARNING: Warning of electrical hazard!

- Make sure that the main voltage used corresponds to the main voltage indicated on the printer's rating plate.
- Only connect the printer to a properly grounded and separately fused socket.
- Do not connect the printer to either a switch-operated or a timer-controlled socket.
- When using an extension cable, make sure that the rated current value of the printer does not exceed the ampere rating of the extension cable.
- When connecting the printer to the power supply, make sure that the building installation is protected with an appropriate fuse.
- Make sure that the power cable is not damaged.
- Leave the power cable in its original condition.
- Do not place any objects on the power cable.
- Make sure that there are no kinks or bending points along the cable.
- Do not pull the plug out of the socket by the cable.

Create a Wired Connection

The printer can be connected to the PC via the USB cable. To connect the printer to the PC, complete the following steps:

1. Connect the electric cable of the printer to a nearby electrical socket.

IMPORTANT Make sure that the socket is easily accessible, and make sure that the plugs are fully inserted into the connection socket of the printer and the electric socket.

2. Place the cables so that there are no tripping hazards.

IMPORTANT Do not connect the USB cable until you have installed the ClearTools software.

Turn the Printer On

To turn the printer on, complete the following steps:

1. Press the main switch on the rear of the device ([Figure 4 on page 12](#)).
The standby button (1) lights up green, which indicates that:
 - The printer is ready for operation.
 - The printer has no current print job.

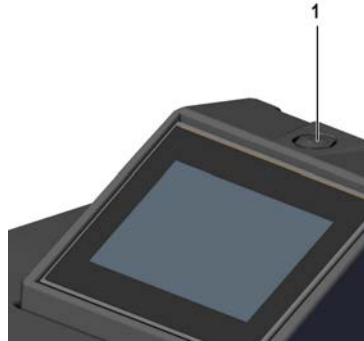

When the standby button (1) is orange, it indicates that:

- The printer is in standby mode.
- The printer is processing a current print job.

Turn the Printer Off (Switch the Printer to Standby Mode)

IMPORTANT Turning off the printer at the main switch on the rear of the device can cause the ink nozzles to clog. Automatic cleaning after turning the printer on again becomes necessary.

- Do not turn off the printer.
- Keep the printer in standby mode.
- If the printer will be out of operation for more than three weeks, set the printer to Longer Downtime mode (see [Activate Longer Downtime Mode on page 31](#)).

To switch the printer to standby mode, press the standby button (1) for three seconds.

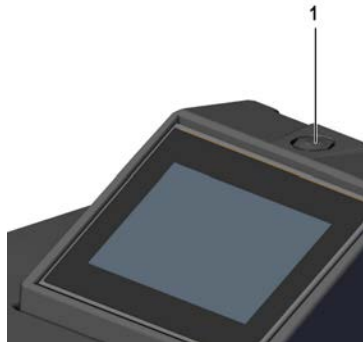

The standby button lights up orange. Only the print head including the control is now supplied with power. This allows the print head to be supplied with ink to prevent it from drying out.

Insert an Ink Cartridge



WARNING: Warning of hand injuries due to sharp objects!
Open the ink tank lid carefully to avoid stab injuries.

IMPORTANT Upon delivery, there are no ink cartridges in the printer.

Before installation of ink cartridges, you must be aware of the following information:

- Open the ink cartridge packaging just before inserting the ink cartridge into the printer.
- New ink cartridges are covered with a protective film at the ink outlet. Do not remove this protective film. The protective film is punctured when the ink cartridge is inserted and remains on the ink cartridge.
- The ink cartridges must not be shaken, disassembled, or refilled.
- Store unopened ink cartridges in a cool and dry location (recommended temperature: 4 °C (39.2 °F)). Before use, the ink cartridges must be warmed up to room temperature for at least three hours.

To insert an ink cartridge, complete the following steps:

1. Slide the ink tank lid (1) in the direction of the arrow.

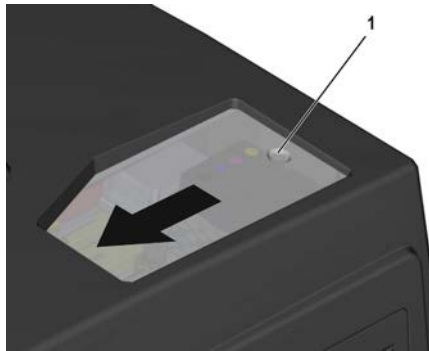

2. Remove the four blue protective caps from the ink supply outlets.

IMPORTANT It is very critical that the blue caps be removed from the ink supply outlets for proper functionality

IMPORTANT Never touch the ink supply outlet.

3. Place each ink cartridge in the designated position.

Each color has a dedicated installation place in the printer, as shown in the following graphic.

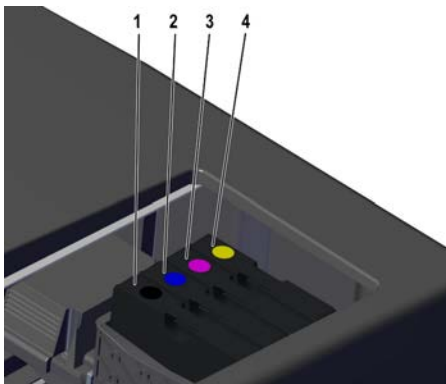

Item	Description
1	Black ink cartridge
2	Cyan ink cartridge
3	Magenta ink cartridge
4	Yellow ink cartridge

4. Make sure that each ink cartridge clicks into place.

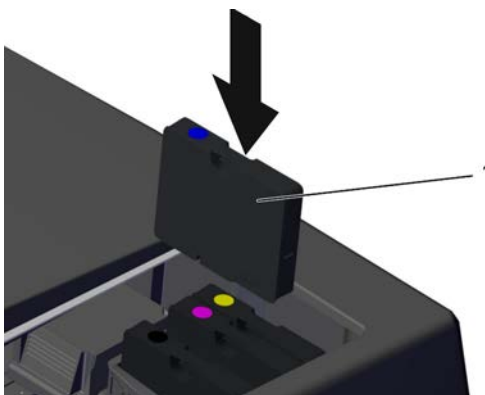

5. When you are finished inserting ink cartridges, close the ink tank lid.

Notes:

Software Installation

Install the ClearTools Software

IMPORTANT For the ClearMark™ Advanced II printer (1492-PCMA2110), you must use ClearTools™ software version 9.4 or higher.

To install the ClearTools software, complete the following steps:

1. Load the ClearTools Software DVD.
2. Click Software.



3. Click ClearTools Software Installation.



The ClearTools Release Notes appear.

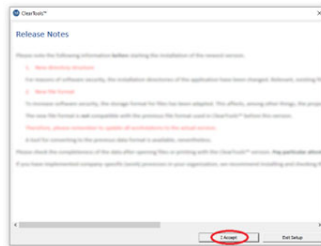

At this point, you can accept the release notes (I Accept) or exit setup (Exit Setup).

4. To continue the installation process, click I Accept
5. In the ClearTools Setup window, click Next.

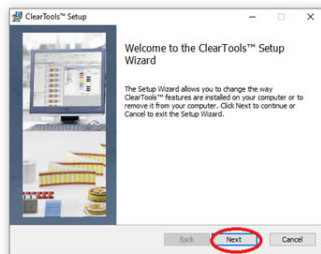

6. Accept the terms and click Next



7. Click Typical.

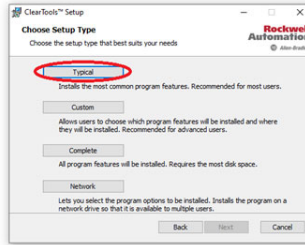

[Table 10](#) describes the other available installation options.

Table 10 - Installation Options

Type of Installation	Description
Typical	The ClearTools software is installed with the most common features.
Custom	The ClearTools software is installed and add-on modules can be selected/deselected.
Complete	The ClearTools software and all add-on modules are installed automatically.
Network	The ClearTools software is installed on a shared drive on the network and can be used by multiple users. In this case, it is only necessary to install the software centrally on a server or central PC. The client PC accesses the ClearTools software via a shared network path.

8. Click Install.

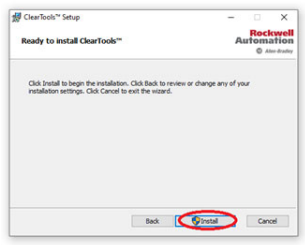

The installation process begins. The systems asks if you agree to allow ClearTools software to make changes to your device. Details of the certificate used to sign the ClearTools Setup are displayed.

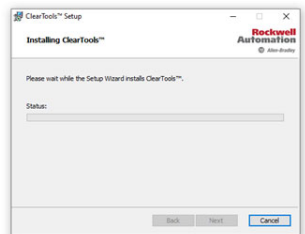

- To complete the installation, click Finish.

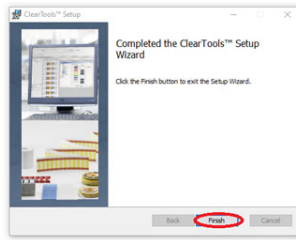

The ClearTools software is installed on your PC.

Install the Printer and Drivers

Installation of the ClearMark Advanced II marking system is done by the ClearTools software. Connecting the printer by USB is described in the following steps.

Connect to a Computer

Use a USB cable to connect the printer to your computer after the correct version of ClearTools software has been installed on your PC.

USB Installation

To connect the printer to a computer via a USB connection, complete the following steps:

- Start the ClearTools software.
- From the Tools menu, click Printer Administration>Printer Explorer.

The Printer Explorer window appears. This window also appears just after correct installation of the ClearTools software.

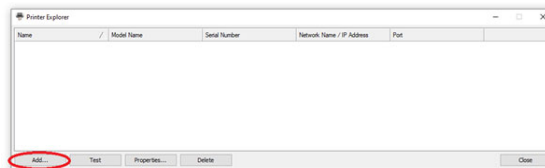

- Click Add.

The Printer Model dialog box appears.

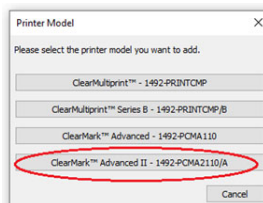

- To start the printer search, click ClearMark™ Advanced II 1492-PCMA2110/A. The ClearTools software automatically searches for connected printers.

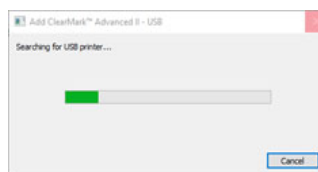

The same USB connection number must be checked in the printer. See the following item in the printer menu: Settings/ Interfaces / USB connection.

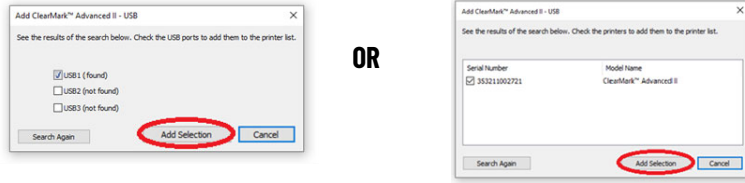

5. Select the required USB port or printer.
6. Click Add Selection selection, and then do one of the following:
 - a. If no printer was found, click Search Again to restart the search process.
 - b. If you have connected your printer to your PC for the first, then you may be required to wait and then repeat the search process.
 - c. If a printer was found, select the printer and click Add Selection.

The Printer Explorer dialog box appears.

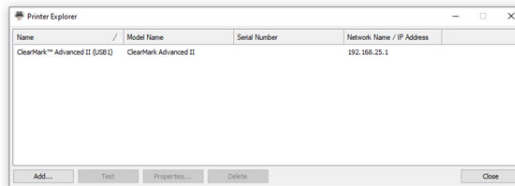

7. To change a printer name, click Properties. The Printer properties dialog box appears.

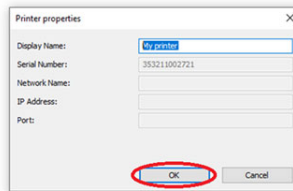

8. In the Display Name field, type the printer name, and then click OK.
9. To check the connection to the printer, in the Printer Explorer dialog box, select the printer that you want to check, and then click Test.

If the printer is connected and accessible, the Connection Test dialog box appears and displays the following message.

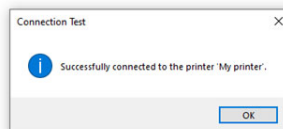

If the printer is not accessible, for example, if it is turned off, the Connection Test dialog box appears and displays the following message.

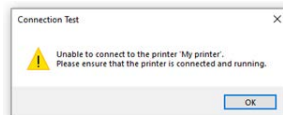

Set up a Marker Card for the Printer

To set the correct print position for a marker card and to compensate for physical changes to it, you must adjust settings via the ClearTools software. Marker types may not be their normal size, for example, as a result of the ambient temperature.

To set up a marker card, complete the following steps:

1. From the File menu, select File -> Adjust Marker Type.

The Adjust Marker Type dialog box appears (the dialog box may be different depending on the chosen marker card).

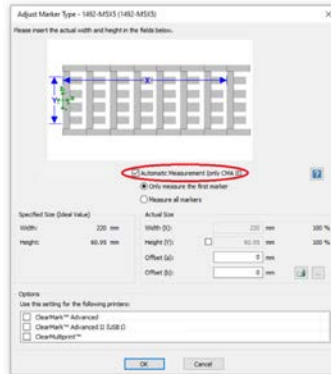

2. Select Automatic Measurement (only CMA II).

IMPORTANT The ClearMark Advanced II printer automatically measures the markers.

3. Under Automatic Measurement (only CMA II), select one of the available options:

- Only measure the first marker:

Within a print job, only the first page of each new marker type is measured, as shown in the following graphic.

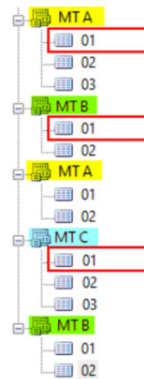

- Measure all markers

All pages within the print job to the ClearMark Advanced II printer are measured.

4. To determine the settings manually, you must print a marker card.

The marker card must not be cured in the calibration process. The printed marker card can be cleaned with cold water and used again. For more details, please refer to the ClearTools help file.

Run a Print Test

After you turn on the printer, you can run a print test of a marker card.

To run a print test, complete the following steps:

1. In the Jobs menu, select Demo print jobs.
2. Choose a template that corresponds to the supplied marker card.
3. Insert the marker card into the input tray.
4. Click Print to start the print test.

Notes:

Operations

**WARNING: Warning of crush hazard!**

Do not operate the printer without its enclosure and do not reach through its openings while it is running.

**WARNING: Warning of automatic startup!**

The printer can start up at any time without warning when a print job is sent over the USB connection.

**WARNING: Warning of hot surface!**

Contact with hot components of the output magazine and marker cards can cause burns.

- Make sure that all components have cooled down to ambient temperature before conducting any work on the output tray.
- Let the marker cards cool down before removing them from the output tray.

IMPORTANT

Using expired ink reduces the print quality and may cause damage to the printer.

Before using the printer, you must be aware of the following information:

- The openings in the printer enclosure must not be blocked or covered.
- Do not insert any objects into openings.
- Make sure that no liquid gets into the printer.
- Do not turn off the printer! The printer automatically switches to standby mode.

The operating parameters are only retained while the printer is turned on. These parameters ensure, for example, that the print head is cleaned optimally.

Activate Longer Downtime Mode

IMPORTANT

If the printer is turned off and de-energized, or is not used, this can lead to clogging of the ink nozzles after a certain amount of time.

To avoid problems with the printer, observe the following guidelines if the printer is not used for three weeks or longer:

- Leave the printer turned on.
- Replace the ink cartridges with fluid cartridges.
- To avoid clogging of the ink, use the Longer downtime function. In Longer downtime mode, the fluid replaces the ink and helps prevent the ink lines and nozzles from drying up.

To prepare the printer for longer downtime, complete the following steps:

1. Replace the ink cartridges with fluid cartridges.

For more information, see [Replace Ink Cartridges and Fluid Cartridges on page 42](#).

2. From the Maintenance menu, select Activate downtime.
The Longer downtime dialog box appears.

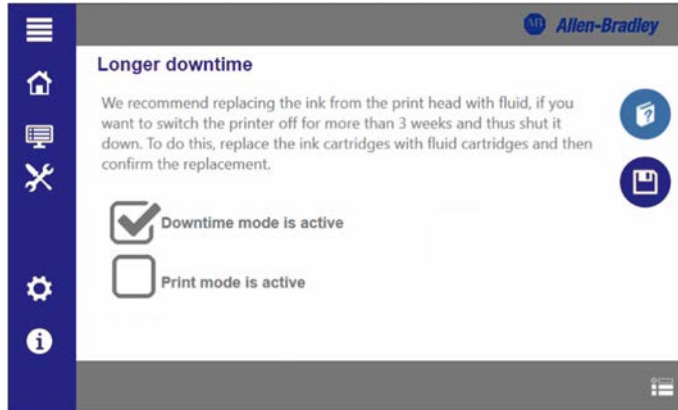

3. Select Downtime mode is active, and then press the Save button.
The rinsing process begins.
4. Wait until the rinsing process is finished.
5. Turn off the printer with the standby button on the touch panel.
For more information, see [Turn the Printer Off \(Switch the Printer to Standby Mode\) on page 21](#).
6. Turn off the printer at the main switch on the rear of the device.
For more information, see [Figure 4 on page 12](#).
7. Remove all marker cards from the input tray and the output tray.
8. Fold the lifting units upwards.
9. Insert the output tray.
10. Disconnect all cables from the printer.
11. Secure the ink tank lid with adhesive tape.

Restore Operational Readiness of the Printer

To restore the operational readiness of the printer after a longer downtime, complete the following steps:

1. Replace the fluid cartridges with ink cartridges.
2. Turn on the printer.
3. Activate print mode by doing the following:
 - a. From the Maintenance menu, select Activate downtime.
 - b. In the Longer downtime dialog box, select Print mode is active, and then press the Save button.

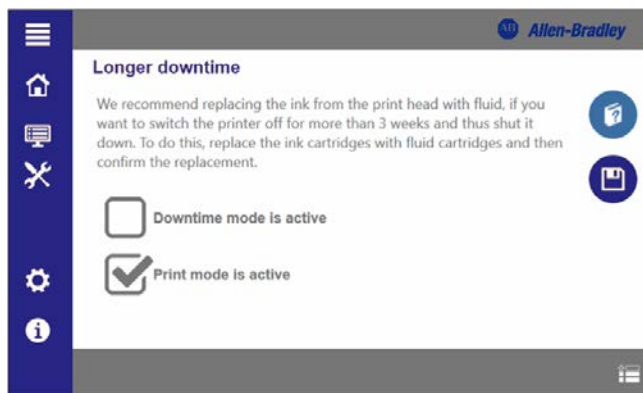

Shelf Life of the Ink

Removing the ink cartridges can cause leaks in the connection between the ink cartridge and the ink line. This condition can lead to a faulty ink feed system.

- Only remove an ink cartridge when it is empty or out of date.
- Do not use out-of-date ink. If the use-by date of the ink is almost reached, a message appears on the touch panel. Replace the specified ink cartridge. For more information, see [Replace Ink Cartridges and Fluid Cartridges on page 42](#).
- Only use products (ClearTools™ software, marker cards, and ink cartridges) that have been produced or approved by Rockwell Automation. Otherwise, no liability can be assumed for the print quality and durability.

IMPORTANT Printer faults and damage that is caused by the use of unapproved and unsuitable accessories and consumables are excluded from the warranty.

Insert Marker Cards

Marker cards can be inserted directly without any pretreatment.

Insert the marker card by ensuring that the side with the closed strip is facing the printer (as shown in the following graphic).

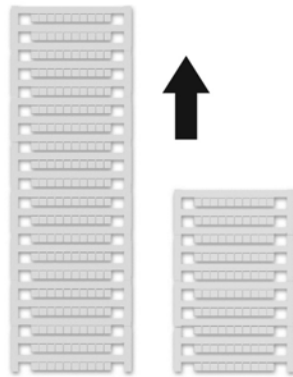

Process a Stack of Marker Cards

When you process a stack of marker cards, follow the guidelines:

- Marker cards can only be inserted in stacks.
- You can insert a stack of up to a maximum of 50 marker cards into the input tray.
- The stack must not exceed 50 marker cards.
- Do not mix half and whole marker cards in a stack.
- Insert the stack of marker cards (1) into the input tray (2) in the direction of insertion shown previously.

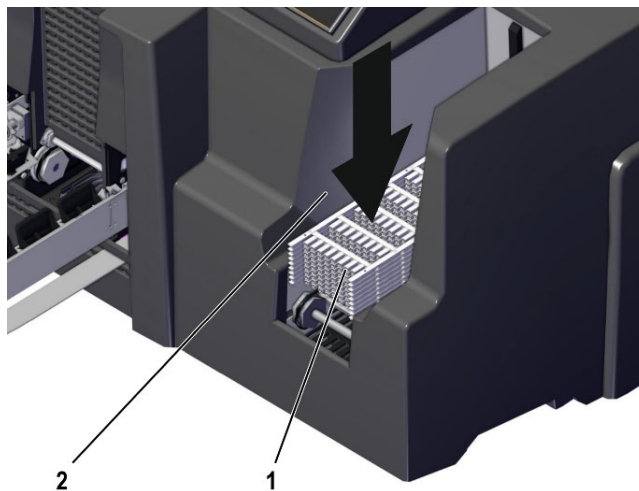

Print a Marker Card

To print a marker card, complete the following steps:

1. Start the ClearTools software.
2. Select the required marker card.
3. Type the text or insert an image or barcode that you want to print.
4. Insert the marker card or the marker card stack.
5. Start printing via ClearTools software.

You can find further information about printing in the help file for the ClearTools software.

Determine Curing Settings and Heating Levels

The settings for curing marker cards differ and are applied automatically. It is possible to set a higher or lower intensity for curing. Details on fine adjustment of the heating level can be found in the ClearTools help file. After cooling, check each marker card for resistance to smudging and scratching.

Select the Print Quality

The print quality is influenced by three different parameters: resolution, color profile, and preheating.

Table 11 - Print Quality Parameters

Parameter	Setting
Resolution	Typical: 300 DPI Quality: 600 DPI Premium: 1200 DPI
Color profile	Text Graphic Optimized
Preheating	Activating/deactivating preheating Setting the preheating time

The printer prints with the CMYK color profile.

The waste heat that is generated during printing is used to preheat the cards in the input tray. The longer the cards are preheated, the higher the print quality.

The time for preheating the cards is configured in the ClearTools software. You can choose between 300 DPI (Typical: possibly without preheating time), 600 DPI, and 1200 DPI (Quality and Premium: with longer preheating times for each card).

For additional information about how to determine the print quality, see the help file for the ClearTools software.

Settings on the Touch Panel

The color touch panel can be rotated through 90° and 180° horizontally and it can be locked in three positions (see [Align the Touch Panel on page 20](#)). The touch panel enables advanced printer control and print job monitoring with information on printer settings and print jobs, and animated help functions for operation, maintenance, and service work.

The following settings are made on the touch panel:

- Viewing, printing, and deleting print jobs
- Printing templates
- Receiving information about the printer, for example, ink cartridge levels, requests for maintenance work
- Conducting maintenance operations

System status

The System status menu displays the current status of the printer: Readiness, fill level of the ink cartridges and the ink collector, and current print jobs.

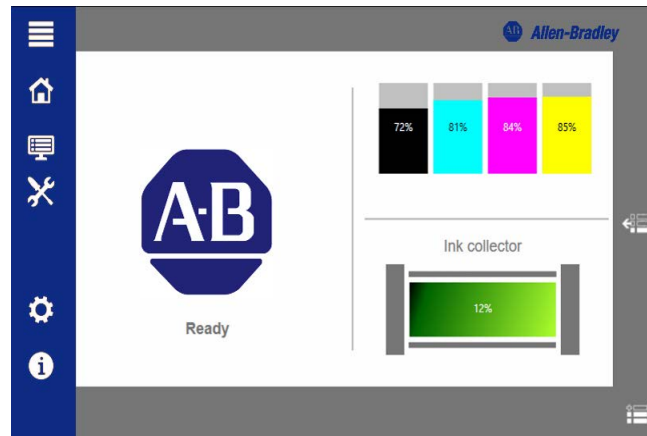

To view the system status, tap Show print jobs.

Up to 50 print jobs that are currently loaded are displayed



Current Jobs

The Current jobs submenu displays the current status of the print jobs that were sent to the printer via the ClearTools software. The sequence of the print jobs can be changed, and print jobs can be deleted.

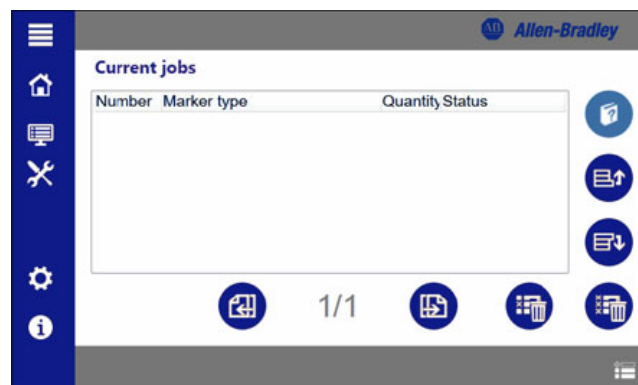

Print job history

The Print job history submenu displays the executed print jobs. Executed print jobs can be printed repeatedly.

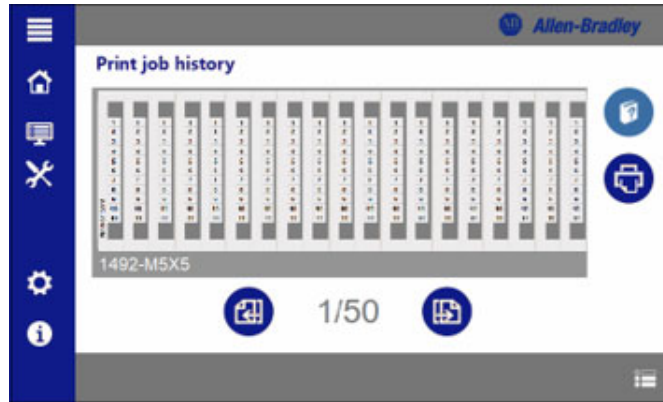

Demo print jobs

The Demo print jobs submenu displays preconfigured print jobs for demonstration purposes. Preconfigured print jobs can be printed and defined by the manufacturer.

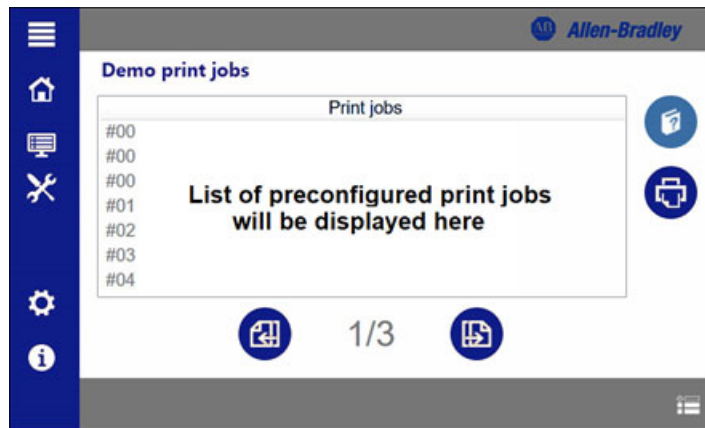

Interfaces / USB Connection

The USB connection submenu helps establish communication via a USB connection.

Print jobs can be sent from the PC to a maximum of three printers via the USB interface. For a configuration of the USB interfaces at the PC, see the ClearTools help file.

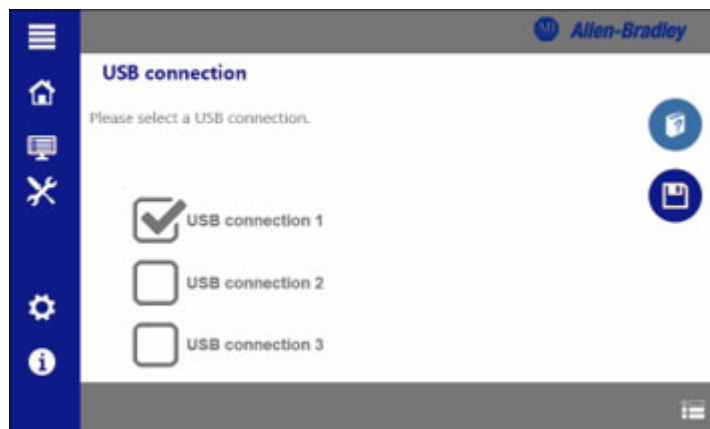

Advanced Settings / Printer

Print jobs can be deleted automatically when the printer is turned off at the main switch. When turning the printer back on, there are no longer any print jobs in the Current print jobs list.

- Activate the function if print jobs are to be deleted.
- Click Save to save the settings.

System Information

The System information submenu provides information on printer parameters and characteristics.



Notes:

Cleaning and Maintenance

**SHOCK HAZARD: Danger of death due to electric shock!**

Never remove the enclosure from the device when conducting any maintenance and cleaning work.

**WARNING: Danger of injury!**

Wear protective equipment during the following maintenance and cleaning work:

- Manual cleaning of the print heads
- Replacing ink cartridges
- Replacing ink cartridges with fluid cartridges
- Replacing the ink collector

IMPORTANT

Harsh cleaning agents can damage a printer. Do not use any scouring agents or solvents to clean the outer surfaces and the touch panel.

Software-controlled Maintenance

The following maintenance work is performed or supported on the touch panel in the Maintenance menu:

- Nozzle check in the Nozzle check submenu (see [Perform a Nozzle Check on page 39](#)).
- Automatic print head cleaning in the Print head cleaning submenu (see [Clean the Print Head Automatically on page 40](#)).
- Preparing the printer for longer storage in the Longer downtime submenu (see [Activate Longer Downtime Mode on page 31](#)).

Perform a Nozzle Check

The nozzle check, which is used to check the correct functionality of the print head nozzles, can be executed in the Nozzle check submenu. The nozzle check is loaded into the Current jobs list, and it is executed as soon as a current print job is completed.

To perform a nozzle check, complete the following steps:

1. Tap the available marker card variant (for example, 1492-M5X5) for the nozzle check.
2. Insert the marker card for the nozzle check, and observe the sequence of the previously inserted marker cards.

- From the Maintenance menu, select Nozzle check.
The Nozzle check dialog box appears.

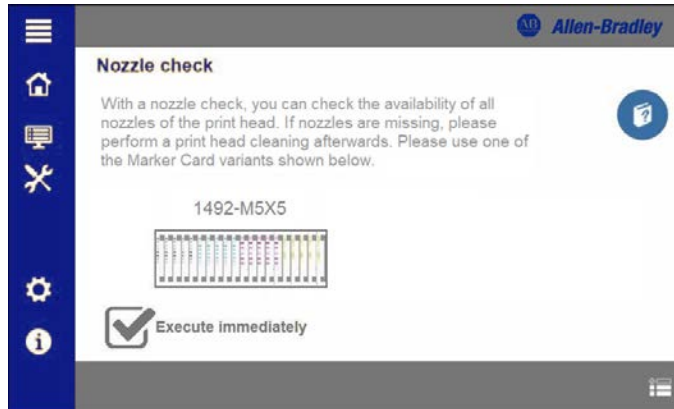

- Select Execute immediately.
- When the card is printed, compare the results with the results shown in [Table 12](#).

Table 12 - Print Images after the Nozzle Check

Nozzle Check Result	Status	Recommended Action
	Print image: 100% functional nozzles All nozzles are fully functional.	Print head cleaning is not necessary.
	Print image: Approximately 90% functional nozzles. Approx. 90% of the nozzles are fully functional.	Execute nozzle head cleaning with the Low setting. For more information, see Clean the Print Head Automatically on page 40 .
	Print image: Approximately 75% functional nozzles. Approx. 75% of the nozzles are fully functional.	Execute nozzle head cleaning with the Normal setting. For more information, see Clean the Print Head Automatically on page 40 .
	Print image: Approximately 50% functional nozzles. Approx. 50% of the nozzles are fully functional.	Execute nozzle head cleaning with the Intensive setting. For more information, see Clean the Print Head Automatically on page 40 .

Clean the Print Head Automatically

Use the print head cleaning function in the Maintenance menu, if the print head requires cleaning.

IMPORTANT Ink is consumed during print head cleaning.

Observe the fill level of the ink cartridges.

Before doing a print head cleaning at the Intensive setting, replace the ink cartridges with new cartridges, if the fill level is less than 10%.

Observe the residual capacity of the ink collector

Before doing a print head cleaning, replace the ink collector, if the residual capacity is less than 10%.

Ink is consumed at these levels during a print head cleaning:

- Setting at Low: Approx. 0.5%
- Setting at Normal: Approx. 1.0%
- Setting at Intensive: Approx. 7.0%

Execute an automatic print head cleaning, if the nozzle check shows insufficient print quality.

To perform an automatic print head cleaning, complete the following steps:

1. From the Maintenance menu, select Print head cleaning.
The Print head cleaning dialog box appears.

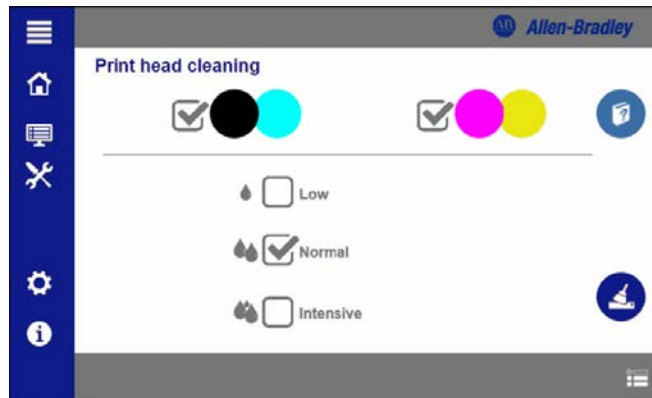

2. Select the nozzles for print head cleaning.
3. Select the level of intensity for cleaning.
4. Click the Clean icon (located in the lower-right corner).
The automatic print head cleaning process begins.

If automatic print head cleaning does not improve the print image, clean the print heads manually. For more information, see [Clean the Print Head Manually on page 41](#).

Clean the Print Head Manually

Manual print head cleaning can be used to remove hardened ink residue that has not come off the nozzle plate during automatic print head cleaning.

IMPORTANT Two cleaning wipes are included in the spare parts set (1492-PCMACLEANER Ser A, PN-505642) for cleaning the two print heads. Use a separate cleaning wipe for each print head

To perform a manual print head cleaning, complete the following steps:

1. Wait until the printer has stopped.
2. Press the releasing device (2) to the left.
3. Remove the side flap (1).



The print head moves to the maintenance position.

4. Wipe the first print head (1) with a cleaning wipe.

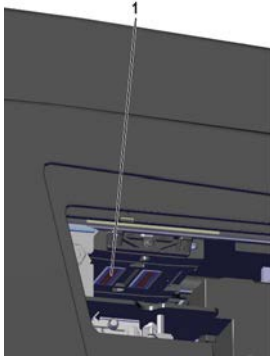

5. Wipe the second print head (2) with a second cleaning wipe.

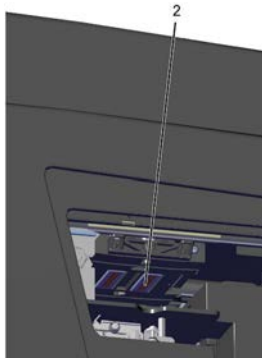

6. Close the side flap.

Replace Ink Cartridges and Fluid Cartridges



WARNING: Danger to health from ink and fluid!

- Wear protective gloves when replacing the ink and fluid cartridges.
 - After skin contact, clean the affected areas thoroughly with soap and water.
 - If ink or fluid has entered your eyes, immediately rinse your eyes thoroughly with plenty of water.
 - If you have swallowed ink or fluid, immediately rinse out your mouth and drink plenty of water. Do not induce vomiting.
 - Keep the ink and fluid cartridges out of reach of children.
-

IMPORTANT Using expired ink reduces the print quality and may damage the printer.

IMPORTANT Do not replace the ink cartridges until all current print jobs have been completed.

IMPORTANT The fluid cartridges are replaced in the same way as the ink cartridges. The fluid cartridges have a shelf life of two years.

Replace the ink cartridges when they are empty, or their expiration date has been reached. In both cases, a message appears on the touch panel. The use-by date is printed on the packaging and on the label.

Before installation of ink cartridges you must be aware of the following information:

- Never touch the ink supply outlet of the ink cartridge or the area around it.
- The ink cartridges must not be shaken, disassembled, or refilled.

- Store unopened ink cartridges in a cool and dry location (recommended temperature: 4 °C (39.2 °F)). Before use, warm the ink cartridges to room temperature for at least three hours.
- Install ink cartridges in the printer immediately after removing them from the packaging.
- When switching from downtime mode to print mode, the reliability check performed then consumes 7% of the ink. The ink fill level can be read on the touch panel.

To replace the ink cartridge or fluid cartridge, complete the following steps:

1. Push the ink tank flap (1) in the direction of the arrow.

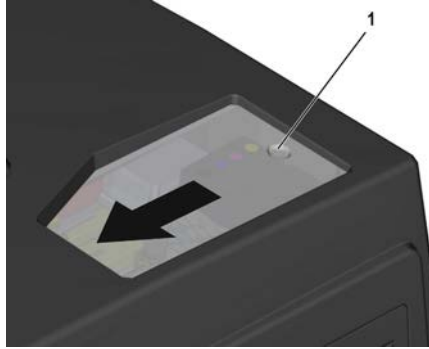

2. Unlock the ink cartridges by pressing the lug in the direction of the arrow.

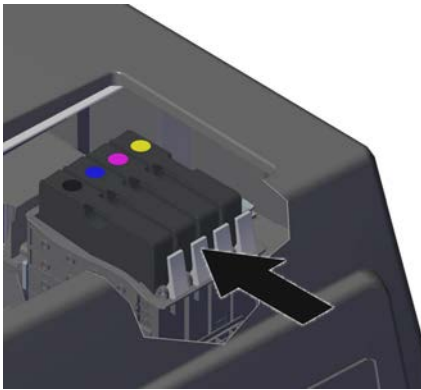

3. Remove each ink cartridge by pulling it upward.

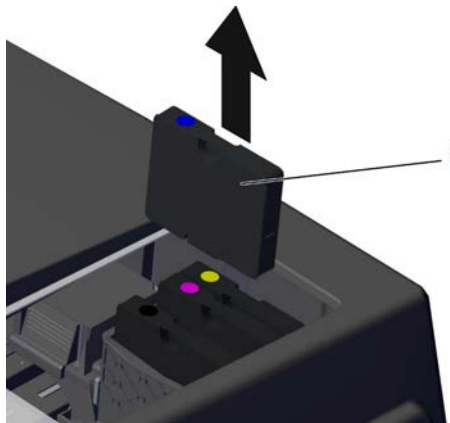

4. Push the new ink cartridge (1) into the defined position until it clicks into place.

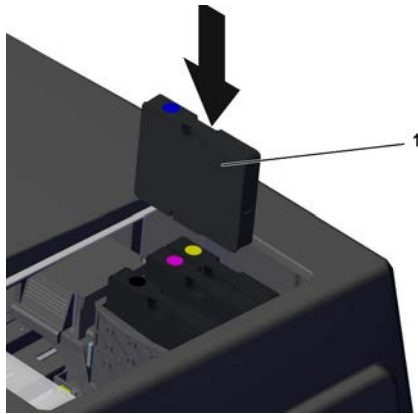

Ink cartridges must be placed in the following order:

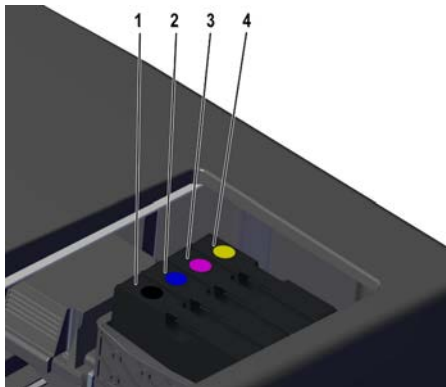

Item	Description
1	Black ink cartridge
2	Cyan ink cartridge
3	Magenta ink cartridge
4	Yellow ink cartridge

If you are installing a fluid cartridge, the order does not matter.

Replace the Ink Collector

IMPORTANT Do not replace the ink collector until all current print jobs have been completed and a message requesting replacement appears on the touch panel.

IMPORTANT The ink collector must be replaced completely. It must not be opened.

To replace the ink collector, complete the following steps:

1. Press the releasing device (2) to the left.
2. Remove the side flap (1).

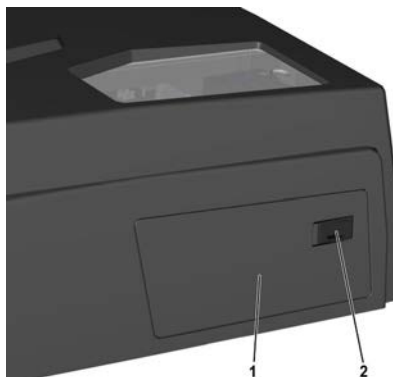

When you open the side flap, the printer stops.

- Lift the ink collector slightly to overcome the resistance of the flat locking pin and extract the ink collector (1) in the direction of the arrow.

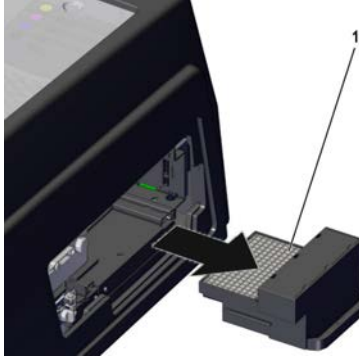

- Remove the seal (1) from the new ink collector.

The new ink collector is equipped with a ventilation safety device (seal). To ventilate the fluid tank during operation, the seal must be removed before inserting the ink collector.

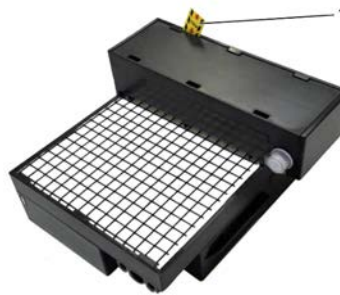

- Insert the new ink collector (1) into the printer in the direction of the arrow until the ink collector clicks into place.

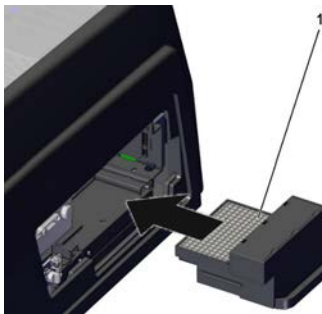

- Close the side flap.

Clean the Printer Enclosure and Touch Panel



WARNING: Warning of electric shock!

- Clean the printer enclosure only from the outside.
- Ensure that no moisture enters the printer or reaches live parts.

IMPORTANT

The use of volatile cleaning agents can lead to color changes and cracks in the printer enclosure.

Do not use volatile chemicals such as benzene or thinner.

Follow these guidelines when cleaning the printer enclosure and touch panel:

- Clean the printer enclosure regularly with a soft, dry, or slightly moistened cloth.

- In case of heavy soiling, initially wipe the printer enclosure with a cloth that is moistened with a neutral cleaning agent, then with a slightly moistened cloth, and finally with a dry cloth.
- Clean the touch panel regularly with a cleaning agent suitable for touch screens and a soft, lint-free cloth.

Troubleshooting

This chapter provides guidelines for solving basic problems that can occur when using the ClearMark™ Advanced II printer.

General Information

The following measures are helpful in avoiding faults:

- Ensure that the printer is installed on a flat, even surface.
- Ensure that the printer is not exposed to vibrations.
- Ensure that the marker cards are aligned correctly.
- Use only original Rockwell Automation ink cartridges, fluid, and accessories.
- When not in use, put the printer in standby or downtime mode.
- Never remove the printer enclosure.

IMPORTANT If you open the ink tank lid, the printer stops. The print head moves to the starting position above the cleaning unit and stops there. When you close the ink tank lid again, the printer continues where it stopped. No information is lost and nothing must be restarted.

Marker Card Left in Turned-off Device

If a marker card remains in the device, turn the device off and on again. The marker card is conveyed out of the device.

Messages on the Touch Panel

A fault at the printer that requires operator intervention is indicated by a message on the touch panel.

To correct the fault, complete the following steps:

1. Tap the error message.



A window opens showing the complete error message.

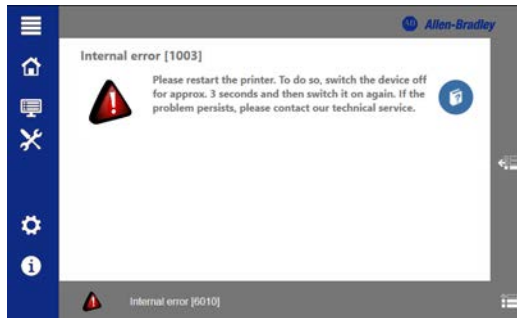

2. Tap Show help to get more information about the fault.
3. Contact Rockwell Automation if a fault cannot be rectified.
4. Tap Close help to hide the window.

Troubleshooting List

[Table 13](#) lists additional faults that can occur, and it also provides actions you can take to correct the faults.

Table 13 - Troubleshooting list

Fault/Code	Reason	Measure
The printer cannot be connected via USB cable.	The USB cable is defective.	Replace the defective USB cable with an intact USB cable.
	An incorrect USB port was selected.	Select a different USB port. For more information, see Interfaces / USB Connection on page 36 .
The print image quality is poor.	The print head nozzles are clogged.	Perform a nozzle check. For more information, see Perform a Nozzle Check on page 39 . Depending on the results of the nozzle check, perform either an automatic print head cleaning or a manual print head cleaning. For more information, see Clean the Print Head Automatically on page 40 or Clean the Print Head Manually on page 41 .
The ink has not cured sufficiently and can smear.	The curing performance is too weak.	Increase the curing performance in the ClearTools™ software. For more information, see the ClearTools help file.
	The supply voltage is too low.	Ensure that the value for the voltage supply is at least 210V (for a 230V grid) /105V (for a 115V grid). The value for the voltage supply can be seen in the System Information submenu. For more information, see System Information on page 37 .
The printed markers display bubbles after printing.	The curing performance is too strong.	Reduce the curing performance in the ClearTools software. For more information, see the ClearTools help file.
	The supply voltage is too high.	Ensure that the value for the voltage supply is maximum 240V (for a 230V grid) /125V (for a 115V grid). The value for the voltage supply can be seen in the System Information submenu. For more information, see System Information on page 37 .
The print is not centered on each marker.	The adjustment function in the ClearTools software is not enabled.	Enable the automatic adjustment function in the ClearTools software. For more information, see the ClearTools help file.

Technical Data

Printer Specifications

Table 14 - Technical Data

Item	Description
Print material	Rockwell Automation print materials (Bulletin 1492 marker cards)
Technology	Ink-jet process with heat curing
Print quality	3 levels (Typical, Quality, Premium)
Marking software	ClearTools™ software (version 9.4 or higher)
System requirements	Windows® 10.11
Feed	Magazine for a maximum of 50 marker cards
Print speed	Up to 3 marker cards per minute, depending on the selected parameter (with typical quality and without automatic calibration).
Interfaces	USB
Voltage supply	230V AC/4.5 A, 115V AC/8.5 A
Fuse	10 ATH 250V AC
Operating location	Office conditions
Ambient temperature	18 °C...30 °C (65 °F...86 °F)
Relative air humidity	10%...80%
Dimensions (L x W x H)	Length, including output tray: 1133 mm (44.61 in.) Length, excluding output tray: 930 mm (36.61 in.) Width: 590 mm (23.23 in.) Height, including touch panel: 454 mm (17.87 in.)
Ink system	Color cartridges, 1 x black, 1 x cyan, 1 x magenta, 1 x yellow (Not included with printer)
Weight, typical	Net Weight: 46 Kg (101.41 lb) Gross weight: 63 Kg (138.89 lb)

Notes:

Service Parts and Accessories

Replacement Parts

Table 15 - Service Parts and Accessories

Product / Spare part	Rockwell Automation® catalog no.
Cyan ink cartridge	1492-PCMA2INK-C
Magenta ink cartridge	1492-PCMA2INK-M
Yellow ink cartridge	1492-PCMA2INK-Y
Black ink cartridge	1492-PCMA2INK-K
Cleaning unit	1492-PCMA2CLUNIT
Fluid cartridge set	1492-PCMA2FLUID
Ink collector	1492-PCMA2COLLECT
Cleaner tissues	1492-PCMACLEANER

Notes:

Decommissioning the Printer

IMPORTANT If the printer is not in operating mode or standby mode, the ink nozzles clog. In these situations, switch the printer to longer downtime mode.

Set Longer Downtime Mode

If you anticipate that the printer will not be used for more than three weeks, you must set the printer to longer downtime mode. The longer downtime procedure is described in [Activate Longer Downtime Mode on page 31](#).

Pack and Transport the Printer



WARNING: Crush hazard during transport!

The printer is heavy and must be transported by two people.

Always hold the printer at the front and rear when transporting it.

Only use the original packaging material when transporting the printer.

Notes:

Cleaning Unit Replacement

IMPORTANT Do not replace the cleaning until all current print jobs have been completed and a message requesting replacement appears on the touch panel.



SHOCK HAZARD: Warning of electrical hazard!

Work on the electrical components of the printer must only be carried out by electrical specialists.

Disconnect the printer from the electrical grid before service operations.



WARNING: Crush hazard during transport!

The printer is heavy and must be transported by two people.

Always hold the printer at the front and rear when transporting it.



WARNING: Warning of hand injuries due to sharp objects!

Open the ink tank lid carefully to avoid stab injuries.



WARNING: Burn hazard due to hot surfaces!

Contact with hot components and cards may cause burns.

Make sure that all components have cooled down to ambient temperature before conducting any service or maintenance work.

Remove the Cleaning Unit

When you need to remove the cleaning unit (shown in the following graphic), you need a Torx T10 screwdriver to complete the task.

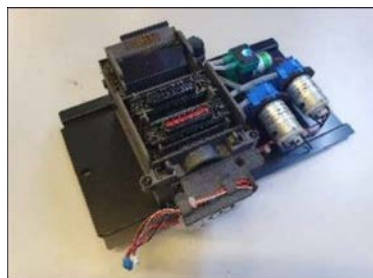

To remove the cleaning unit, complete the following steps:

1. Disconnect the printer from its power source.
2. Pull out the ink collector and place it on a flat, stable surface.
For more information, see [Replace the Ink Collector on page 44](#).

- 3. Undo the 2 screws.

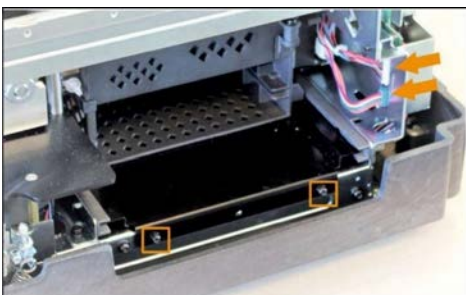

- 4. Disconnect both plugs.
- 5. Gently turn the brass gearwheel clockwise to unlock the print head.



- 6. Push the print head to the left and out of the cleaning unit area.

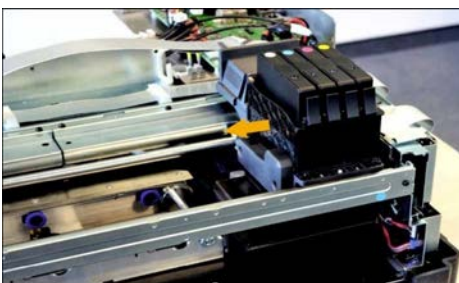

- 7. Pull out the cleaning unit and remove it.

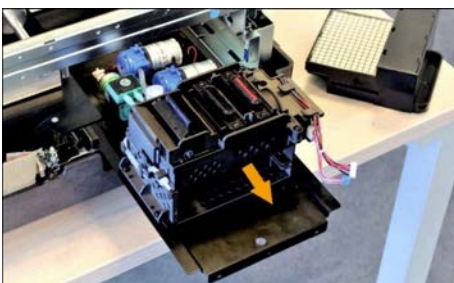

Install the Cleaning Unit

After the old cleaning unit is removed, install the new cleaning unit by following the reverse order of the steps that are described in [Remove the Cleaning Unit on page 55](#).

Rockwell Automation Support

Use these resources to access support information.

Technical Support Center	Find help with how-to videos, FAQs, chat, user forums, Knowledgebase, and product notification updates.	rok.auto/support
Local Technical Support Phone Numbers	Locate the telephone number for your country.	rok.auto/phonesupport
Technical Documentation Center	Quickly access and download technical specifications, installation instructions, and user manuals.	rok.auto/techdocs
Literature Library	Find installation instructions, manuals, brochures, and technical data publications.	rok.auto/literature
Product Compatibility and Download Center (PCDC)	Download firmware, associated files (such as AOP, EDS, and DTM), and access product release notes.	rok.auto/pcdc

Documentation Feedback

Your comments help us serve your documentation needs better. If you have any suggestions on how to improve our content, complete the form at rok.auto/docfeedback.

Waste Electrical and Electronic Equipment (WEEE)



At the end of life, this equipment should be collected separately from any unsorted municipal waste.

Rockwell Automation maintains current product environmental compliance information on its website at rok.auto/pec.

Rockwell Automation maintains current product certification documents on its website at rok.auto/certifications.
For the latest product information updates please check the above links or www.rockwellautomation.com.





FCC NOTE: This equipment has been tested and found to comply with the limits for a Class A digital device, pursuant to Part 15 of the FCC Rules. These limits are designed to provide reasonable protection against harmful interference when the equipment is operated in a commercial environment. The equipment generates, uses, and can radiate radio frequency and, if not installed and used in accordance with the instruction manual, may cause harmful interference to radio communications. Operation of this equipment in a residential area is likely to cause harmful interference in which case the user may be required to correct the interference at his own expense.

Allen-Bradley, ClearMark, ClearTools, expanding human possibility, and Rockwell Automation are trademarks of Rockwell Automation, Inc.

Windows is a trademark of Microsoft, Inc.

Trademarks not belonging to Rockwell Automation are property of their respective companies.

Rockwell Otomasyon Ticaret A.Ş. Kar Plaza İş Merkezi E Blok Kat:6 34752, İçerenköy, İstanbul, Tel: +90 (216) 5698400 EEE Yönetmeliğine Uygundur

Connect with us.    

rockwellautomation.com ————— **expanding human possibility®**

AMERICAS: Rockwell Automation, 1201 South Second Street, Milwaukee, WI 53204-2496 USA, Tel: (1) 414.382.2000

EUROPE/MIDDLE EAST/AFRICA: Rockwell Automation NV, Pegasus Park, De Kleetlaan 12a, 1831 Diegem, Belgium, Tel: (32) 2663 0600

ASIA PACIFIC: Rockwell Automation SEA Pte Ltd, 2 Corporation Road, #04-05, Main Lobby, Corporation Place, Singapore 618494, Tel: (65) 6510 6608

UNITED KINGDOM: Rockwell Automation Ltd., Pitfield, Kiln Farm, Milton Keynes, MK11 3DR, United Kingdom, Tel: (44)(1908) 838-800

Publication 1492-UM012B-EN-P - November 2024

DIR 10007001723 (Version 01)

Supersedes Publication 1492-UM012A-EN-P - November 2022

Copyright © 2024 Rockwell Automation, Inc. All rights reserved. Printed in the U.S.A.