



Allen-Bradley

DeviceNet™ Communication Module

Catalog Number 160-DN2

Firmware 3.xxx

User Manual

**Rockwell
Automation**

Important User Information

Solid state equipment has operational characteristics differing from those of electromechanical equipment. “*Safety Guidelines for the Application, Installation and Maintenance of Solid State Controls*” (Publication SGI-1.1 available from your local Rockwell Automation Sales Office or online at <http://www.ab.com/manuals/gi>) describes some important differences between solid state equipment and hard-wired electromechanical devices. Because of this difference, and also because of the wide variety of uses for solid state equipment, all persons responsible for applying this equipment must satisfy themselves that each intended application of this equipment is acceptable.

In no event will Rockwell Automation, Inc. be responsible or liable for indirect or consequential damages resulting from the use or application of this equipment.

The examples and diagrams in this manual are included solely for illustrative purposes. Because of the many variables and requirements associated with any particular installation, Rockwell Automation, Inc. cannot assume responsibility or liability for actual use based on the examples and diagrams.

No patent liability is assumed by Rockwell Automation, Inc. with respect to use of information, circuits, equipment, or software described in this manual.

Reproduction of the contents of this manual, in whole or in part, without written permission of Rockwell Automation, Inc. is prohibited.

Throughout this manual we use notes to make you aware of safety considerations.



ATTENTION: Identifies information about practices or circumstances that can lead to personal injury or death, property damage, or economic loss.

Attentions help you:

- identify a hazard
- avoid the hazard
- recognize the consequences

Important: Identifies information that is especially important for successful application and understanding of the product.



Shock Hazard labels may be located on or inside the drive to alert people that dangerous voltage may be present.

DeviceNet is a trademark of the Open DeviceNet Vendor Association.

SSC is a registered trademark of Rockwell Automation, Inc.

Allen-Bradley, ControlLogix, PLC-5, and SLC are trademarks of Rockwell Automation, Inc.

RSLinx, RSLogix, and RSNetWorx for DeviceNet are trademarks of Rockwell Software.

Summary of Changes

The information below summarizes the changes made to this manual since its last release (March, 1999):

Location	Description of Changes																								
Chapter 3	Added three new sections — Surge-Suppression, Common Mode Noise, and Output Disconnect — after the Low Voltage Directive 73/23/EEC Compliance section.																								
Chapter 5	Added EDS file search screen and removed obsolete Table 6 (EDS files for Bulletin 160 using a 160-DN2 version 3.000 or later).																								
Chapter 6	Replaced DeviceNet Manager software references and screens with those of RSNetWorx for DeviceNet. Added I/O and explicit messaging information and ladder logic examples for ControlLogix, PLC-5, and SLC controllers.																								
Chapter 7	In the “Understanding the FAULT LED” section, added Bulletin 160 Fault Codes 11, 20, 36, and 46 to the table on pages 7-3 and 7-4 .																								
Appendix B	<p>In section “Class Code 0xB3 — 160 Parameter Table Object” in the “Instance 1 Attributes” chart on pages B-18 and B-19, corrected the Data Types for these Attribute IDs:</p> <table border="1" style="margin-left: 40px;"> <thead> <tr> <th style="text-align: left;">Attribute ID</th> <th style="text-align: left;">Parameter Name</th> <th style="text-align: left;">Data Type</th> </tr> </thead> <tbody> <tr> <td>9</td> <td>Drive Status</td> <td>WORD (was USINT)</td> </tr> <tr> <td>10</td> <td>Drive Type</td> <td>USINT (was UINT)</td> </tr> <tr> <td>12</td> <td>Input Status</td> <td>WORD (was USINT)</td> </tr> <tr> <td>15</td> <td>Preset Status</td> <td>WORD (was USINT)</td> </tr> <tr> <td>33</td> <td>Maximum Freq</td> <td>UINT (was USINT)</td> </tr> <tr> <td>35</td> <td>Base Frequency</td> <td>UINT (was USINT)</td> </tr> <tr> <td>39</td> <td>Skip Frequency</td> <td>UINT (was USINT)</td> </tr> </tbody> </table> <p>In section “Class Code 0x04 — Assembly Objects,” subsection “Instance Data Format: Output Assemblies” on page B-24, added new footnotes for Instance 21 in bit 5 and bit 6 columns. Re-arranged numerical order of all footnotes on this page.</p> <p>In section “Class Code 0x04 — Assembly Objects,” subsection “Instance Data Format: Output Assemblies” on page B-25, added a new footnote for Instance 101 in bit 0, bit 1, and bit 2 columns. Re-arranged numerical order of all footnotes on this page.</p> <p>In section “Class Code 0x04 — Assembly Objects,” subsection “Configuration Assembly Data Formats,” deleted unnecessary Instance 190 table (pages B-29 through B-34).</p>	Attribute ID	Parameter Name	Data Type	9	Drive Status	WORD (was USINT)	10	Drive Type	USINT (was UINT)	12	Input Status	WORD (was USINT)	15	Preset Status	WORD (was USINT)	33	Maximum Freq	UINT (was USINT)	35	Base Frequency	UINT (was USINT)	39	Skip Frequency	UINT (was USINT)
Attribute ID	Parameter Name	Data Type																							
9	Drive Status	WORD (was USINT)																							
10	Drive Type	USINT (was UINT)																							
12	Input Status	WORD (was USINT)																							
15	Preset Status	WORD (was USINT)																							
33	Maximum Freq	UINT (was USINT)																							
35	Base Frequency	UINT (was USINT)																							
39	Skip Frequency	UINT (was USINT)																							

The March 1999 release of the *Bulletin 160-DN2 DeviceNet Communication Module User Manual* covers the software enhancements of Firmware Version 3.xxx and contains new and updated information.

Bulletin 160-DN2 version 3.xxx Software Enhancements

Features and enhancements in the 160-DN2 module that are different than those in the 160-DN1 module include:

Compatibility with Bulletin 160 drives (Series A, B, and C)

Bulletin 160 (Series A, B, and C) drives can be connected to a DeviceNet network.

Ability to Create Electronic Data Sheets

Configuration tools, such as DeviceNet Manager, can create an Electronic Data Sheet (EDS file) for the 160 SSC drive and 160-DN2 module.

Added Parameter Object

This object describes the parameters in the 160 SSC drive and 160-DN2 module.

Added Parameter Group Object

This object describes the parameter groups associated with the 160 SSC drive and 160-DN2 module.

New and Revised Chapters to this Manual

The bulletin *160-DN2 DeviceNet Communication Module User Manual*, Publication 0160-5.18, is a new manual. It is, however, similar to the *160 DeviceNet Communication Module User Manual*, Publication 0160-5.5. The main differences can be found in the following chapters:

Using This Manual	Preface
Quick Start for Experienced Users	Chapter 2
DeviceNet Parameter Descriptions	Chapter 5
Using the 160-DN2 with DeviceNet Scanner	Chapter 6
Troubleshooting	Chapter 7
DeviceNet Information	Appendix B

Summary of Enhancements to User Manual

Refer to the following references in this manual:

Reference Manuals Section	P-2
Manual Organization	P-3
DeviceNet Compatibility	P-4
Replacing a 160-DN1 with a 160-DN2	P-4
Required Tools and Equipment	3-1
DeviceNet Parameter Descriptions	Chapter 5
Creating EDS Files replaces Installing EDS Files	6-3
Troubleshooting Updated	Chapter 7
Parameter Object	B-9
Parameter Group Object	B-11
Acknowledge Handler Object	B-17

Table of Contents

Using This Manual	Preface	
	Manual Objectives	P-1
	Who Should Use This Manual?	P-1
	Product References	P-1
	Conventions	P-1
	Firmware Version	P-1
	Related Documentation	P-2
	Manual Organization	P-2
	Safety Precautions	P-3
	DeviceNet Compatibility	P-4
Replacing a 160-DN1 with a 160-DN2	P-4	
Rockwell Automation Support	P-4	
	Chapter 1	
Product Overview	Module Description	1-1
	LEDs and DeviceNet Connection	1-1
	DIP Switches	1-2
	Chapter 2	
Quick Start for Experienced Users	Introduction	2-1
	Required Tools and Equipment	2-1
	Procedures	2-2
	Chapter 3	
Installation and Wiring	Required Tools and Equipment	3-1
	EMC Directive 89/336/EEC Compliance	3-2
	Low Voltage Directive 73/23/EEC Compliance	3-2
	Surge Suppression	3-2
	Common Mode Noise	3-4
	Drive Output Disconnect	3-4
	Removing Program Keypad Module or Ready/Fault Panel	3-5
	Understanding Module Configuration Switches	3-5
	Setting the DeviceNet Node Address	3-6
	Setting the Baud Rate	3-7
	Cable Lengths and Baud Rates	3-7
	Installing the Communication Module	3-8
	Wiring the DeviceNet Connector	3-9
	Connecting the DeviceNet Drop Line to the Module	3-10
Removing Communication Module From a Drive	3-10	

	Chapter 4	
Modes of Operation	Powering Up the Drive	4-1
	Modes of Operation.	4-1
	Power-up Reset Mode.	4-1
	Run Mode	4-2
	Error Mode	4-2
	Chapter 5	
DeviceNet Parameter Descriptions	DeviceNet Parameters	5-1
	Electronic Data Sheet (EDS) Files	5-1
	Parameters and EDS File	5-1
	Bulletin 160 SSC Interface	5-2
	Locating EDS Files on the Internet	5-2
	Bulletin 160 SSC Interface Parameters	5-3
	DeviceNet Parameters	5-3
	Drive Display Parameters (Read Only).	5-6
	Drive Program Parameters	5-8
	Chapter 6	
Using 160-DN2 with DeviceNet Scanner	Needed Tools	6-2
	Setting Device MAC ID's.	6-2
	Using RSNetWorx for DeviceNet	6-2
	Going Online	6-2
	Creating an EDS File	6-3
	Accessing and Editing Parameters.	6-4
	Selecting Input and Output Assemblies for I/O Messaging	6-5
	Changing the Output Assembly	6-6
	Changing the Input Assembly	6-6
	Enabling Network Control	6-7
	Configuring Drive Input Mode	6-7
	Modifying Drive Reset Functions	6-8
	Configuring the 160 to Accept Speed Commands from the Network	6-9
	Configuring the Scanner	6-10
	Example Network	6-10
	Setting Up the Scan List	6-11
	Mapping the Drive Data in the Scanner	6-13
	Saving the Configuration.	6-16
	Using I/O Messaging.	6-16
	Example Ladder Logic Programs	6-16
	ControlLogix Example	6-17
	PLC-5 Example	6-19
	SLC Example	6-21
	Using Explicit Messaging	6-23
	About Explicit Messaging	6-23
	Formatting Explicit Messages	6-23
	Executing Explicit Messages.	6-29

	Chapter 7	
Troubleshooting	Understanding the COMM LED	7-2
	Understanding the FAULT LED	7-3
	Appendix A	
Specifications	Electrical	A-1
	Environmental	A-1
	Communications	A-1
	Mechanical	A-1
	Appendix B	
DeviceNet Information	DeviceNet Message Types	B-1
	Object Classes	B-2
	Supported Data Types	B-2
	Class Code 0x01 — Identity Object	B-3
	Class Code 0x03 — DeviceNet Object	B-5
	Class Code 0x05 — Connection Object	B-6
	Class Code 0x0F — Parameter Object	B-9
	Class Code 0x10 — Parameter Group Object	B-11
	Class Code 0x28 — Motor Data Object	B-12
	Class Code 0x29 — Control Supervisor Object	B-13
	State Transition Diagram	B-14
	Run/Stop Event Matrix	B-15
	Class Code 0x2A — AC Drive Object	B-16
	Class Code 0x2B — Acknowledge Handler Object	B-17
	Class Code 0xB3 — 160 Parameter Table Object	B-18
	Class Code 0xB4 — DN Interface Object	B-22
	Class Code 0x04 — Assembly Objects	B-23
	Instance Data Format: Output Assemblies	B-24
	Instance Data Format: Input Assemblies	B-26
	Configuration Assembly Data Formats	B-29
	Index	

Using This Manual

Manual Objectives

The purpose of this manual is to provide you with the necessary information to apply the Bulletin 160 SSC™ DeviceNet™ Communication Module. This manual describes methods to install, configure, and troubleshoot the Bulletin 160 SSC DeviceNet Communication Module.

For information on specific features of the Bulletin 160 SSC drive, refer to the *Bulletin 160 SSC User Manual*.

Important: Read this manual in its entirety before installing, operating, servicing, or initializing the Bulletin 160 DeviceNet Communication Module.

Who Should Use This Manual?

This manual is intended for qualified personnel. To make efficient use of the Communication Module, you must be able to program and operate serial communications devices, as well as have an understanding of the parameter settings and functions of the Bulletin 160 SSC drive.

You should understand DeviceNet network operations, including how slave devices operate on the network and communicate with a DeviceNet master.

Product References

In this manual we refer to the:

- Bulletin 160-DN2 DeviceNet Communication Module as Communication Module and Module.
- Bulletin 160 SSC Variable Frequency AC Drive as the Drive.

Conventions

Parameter names are shown in the format **PXX - [*]** where P denotes parameter, XX represents the parameter number, and * represents the parameter name. For example, **P01 - [Output Frequency]**.

Firmware Version

The firmware release is displayed as FRN X.xxx, where:

- FRN = Firmware Release Number
- X = Firmware (whole) Number
- (.) = Decimal point separator
- xxx = Place holders representing minor updates

Places to the right of the decimal do not affect content of this manual.

Related Documentation

For:	Refer to:	Publication
Bulletin 160 SSC Drive	<i>User Manual Series A</i> <i>User Manual Series B</i> <i>User Manual Series C</i>	0160-5.0 0160-5.9 0160-5.15
RSNetWorx for DeviceNet Software	<i>RSNetWorx for DeviceNet Getting Results Guide</i> Online help (installed with the software)	9398-DNETGR
ControlLogix	<i>ControlLogix User Manual</i>	1756-6.5.13
SLC 500 and 1747-SDN	<i>DeviceNet Scanner Module Installation Instructions</i> <i>DeviceNet Scanner Module Configuration Manual</i>	1747-5.8 1747-6.5.2
PLC5 and 1771-SDN	<i>DeviceNet Scanner Module Installation Instructions</i> <i>DeviceNet Scanner Module Configuration Manual</i>	1771-5.14 1771-6.5.118
DeviceNet Cables and Components	<i>DeviceNet Product Overview</i>	DN-2.5
DeviceNet Network Installation	<i>DeviceNet Cable System Planning and Installation Manual</i>	DN-6.7.2

Important: Read the *DeviceNet Cable System Planning and Installation Manual*, Publication DN-6.7.2, in its entirety before planning and installing a DeviceNet system. If the network is not installed according to this document, unexpected operation and intermittent failures can occur.

Documentation can be obtained online at <http://www.ab.com/manuals>.

Manual Organization

This 160-DN2 Module user manual contains the following sections:

Chapter	Title	Contents
Preface	Using This Manual	Manual objectives, audience, vocabulary, manual conventions and organization, safety precautions, and DeviceNet compatibility.
1	Product Overview	Module description, LEDs, DIP switches, and DeviceNet compatibility.
2	Quick Start for Experienced Users	Communication Module features, configuration, and diagnostics.
3	Installation and Wiring	Installation, switch configuration, cabling, and removal.
4	Modes of Operation	Power-up and modes of operation.
5	DeviceNet Parameter Descriptions	EDS file parameters, Bulletin 160 SSC interface, product codes.
6	Using 160-DN2 with DeviceNet Scanner	Mac IDs, RSNetWorx for DeviceNet, configuration, input/output assemblies, network control, scan list, I/O messaging, ladder program examples, explicit messaging.
7	Troubleshooting	LED indications and fault descriptions.
Appendix A	Specifications	Environmental, electrical, and communication specifications.
Appendix B	DeviceNet Information	DeviceNet message types and object classes.

Safety Precautions

Please read the following safety precautions carefully:



ATTENTION: Risk of injury or death exists. The drive contains high voltage capacitors which take time to discharge after removal of mains supply. Before installing or removing the DeviceNet Communication Module, make sure to isolate the mains supply from line inputs [L1, L2, L3 (R, S, T)]. Wait three minutes for capacitors to discharge to safe voltage levels. Failure to do so may result in injury or death.



ATTENTION: Risk of injury or equipment damage exists. Only personnel familiar with DeviceNet devices, Bulletin 160 SSC drives, and associated machinery should plan or implement the installation, start-up, configuration, and subsequent maintenance of the Communication Module. Failure to comply may result in injury and/or equipment damage.



ATTENTION: Risk of equipment damage exists. This module contains ESD (Electrostatic Discharge) sensitive parts that can be damaged if you do not follow ESD control procedures. Static control precautions are required when handling this Communication Module. If you are unfamiliar with static control procedures, refer to *Guarding Against Electrostatic Damage*, Publication 8000-4.5.2.



ATTENTION: Risk of injury or equipment damage exists. When a system is configured for the first time, there may be unintended or incorrect machine motion. Disconnect the motor from the machine or process during initial system testing.



ATTENTION: Hazard of equipment damage exists. If explicit messages are programmed to frequently change parameter data in the drive, the EEPROM will quickly exceed its life cycle and cause the drive to malfunction. Do not create a program that frequently uses explicit messages to change a parameter in the drive.

DeviceNet Compatibility

The 160-DN2 Communication Module is intended for use only with Bulletin 160 SSC Series A, Bulletin 160 SSC Series B, and Bulletin 160 SSC Series C (FRN 7.03 and later) devices. Bulletin 160 SSC (Series C) devices must use a 160-DN2 Communication Module to connect to a DeviceNet network. Bulletin 160 SSC (Series A and B) devices can use either a 160-DN2 or 160-DN1 Communication Module to connect to a DeviceNet network.

When properly connected, the Communication Module communicates via the DeviceNet Protocol. The Communication Module/Bulletin 160 SSC combination comprise a Group 2 Slave Only device. This device supports DeviceNet slave Polled, Change of State/Cyclic messaging, and DeviceNet slave Explicit messaging. It does not support the Explicit Unconnected Message Manager (UCMM).

Replacing a 160-DN1 with a 160-DN2

You can replace a 160-DN1 Communication Module with a 160-DN2 Communication Module on any 160 SSC (Series A and Series B) drive. To do so, you will need to create an EDS file for the new 160-DN2 Communication Module and map the module to the network. [Chapter 6, Using 160-DN2 with DeviceNet Scanner](#), provides detailed instructions on how to perform these tasks.

Rockwell Automation Support

Rockwell Automation, Inc. offers support services worldwide, with over 75 sales/support offices, over 500 authorized distributors, and over 250 authorized systems integrators located through the United States alone. In addition, Rockwell Automation, Inc. representatives are in every major country in the world.

Local Product Support — Contact your local Rockwell Automation, Inc. representative for sales and order support, product technical training, warranty support, and support service agreements.

Technical Product Assistance — If you need to contact Rockwell Automation, Inc. for technical assistance, please review the information in [Chapter 7, Troubleshooting](#) first. If you still have problems, then call your local Rockwell Automation, Inc. representative.

U.S. Allen-Bradley Drives Technical Support:

E-mail: support@drives.ra.rockwell.com

Tel: (1) 262.512.8176

Fax (1) 262.512.2222

Online: www.ab.com/support/abdrives

UK Customer Support Center:

E-mail: esupport2@ra.rockwell.com

Tel: +44 (0) 870 2411802

Fax: +44 (0) 1908 838804

Germany Customer Service Center:

E-mail: ragermany-csc@ra.rockwell.com

Tel: +49 (0) 2104 960-630

Fax: +49 (0) 2104 960-501

Product Overview

This chapter contains the following information:

- physical layout of the module
- location of configuration switches
- DeviceNet overview and components

Module Description

The Bulletin 160 SSC DeviceNet Communication Module is an optional interface device designed to provide a direct, digital link between DeviceNet devices and the Bulletin 160 SSC drive. The module connects to the Bulletin 160 SSC through the expansion/keypad port on the front of the drive.

LEDs and DeviceNet Connection

Figure 1.1
Module Front View

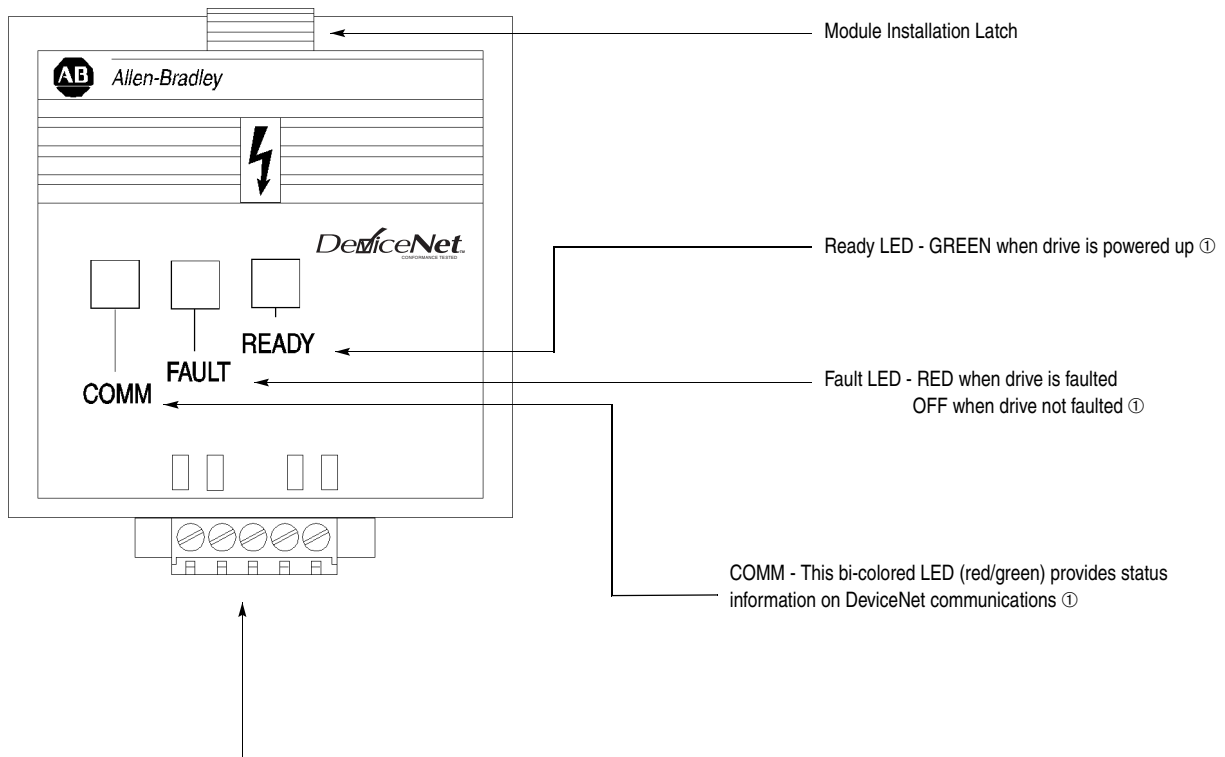

DeviceNet Terminal Block Plug - The Communication Module receives power and communications through this connector.

① See [Chapter 4, Modes of Operation](#), and [Chapter 7, Troubleshooting](#), for detailed operation.

DIP Switches

Figure 1.2 Module Rear View

The Communication Module has one eight position DIP switch for setting the DeviceNet Node Address and Baud Rate. DIP switches are located on the rear of the module and are only accessible when the module is removed from the Bulletin 160 SSC drive.

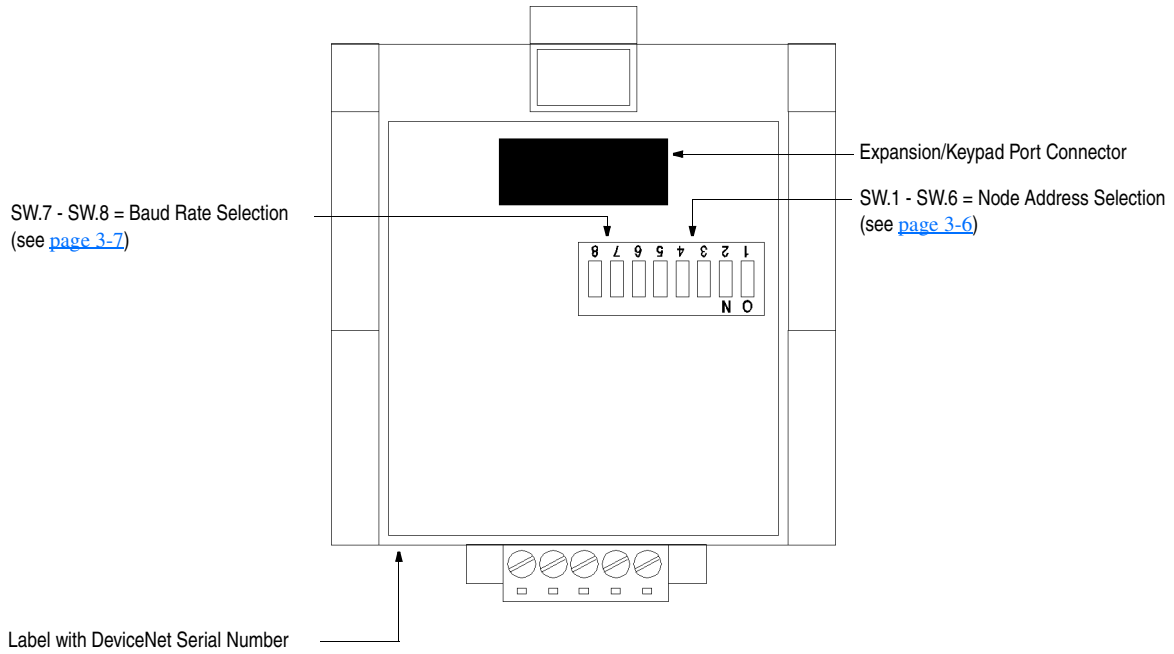

Quick Start for Experienced Users

Introduction

This chapter can help you start using the Bulletin 160 DeviceNet Communication module. If you have previously installed or configured a DeviceNet network and are familiar with Rockwell Automation DeviceNet modules and drives, this information can help reduce installation and startup time. If you are uncertain, use the full installation/configuring information beginning in [Chapter 3](#).

We base the procedures listed in this chapter on the assumption that you understand DeviceNet concepts and know how to program the Bulletin 160 SSC drive. You should also be able to understand electronic process control and interpret the ladder logic instructions required to generate the electronic signals that control your application.

Because it is a *start-up guide for experienced users*, this chapter *does not* contain detailed explanations about the procedures listed. It does, however, reference other chapters in this book where you can get more information.

If you have any questions or are unfamiliar with the terms used or concepts presented in the procedural steps, *always read the referenced chapters* and other recommended documentation before trying to apply the information.

The information contained in this chapter includes:

- What tools and equipment you will need.
- When to address, configure, and program the module.
- How to install and wire the Communication Module.
- System power-up procedures.

Required Tools and Equipment

Have the following tools and equipment ready:

- small blade screwdriver
- DeviceNet configuration software or hardware device

Procedures

Step	Refer to . . .
1 Review Attention statements in the Preface.	Preface
2 Check the contents of the shipping box. Unpack the shipping box, making sure that it contains: <ul style="list-style-type: none"> • Bulletin 160 DeviceNet module (Catalog Number 160-DN2) • 10-pin linear plug with probe holes and jack screws • <i>DeviceNet Communication Module 160-DN2 User Manual</i> If the contents are incomplete, call your local Allen-Bradley representative for assistance.	—
3 Ensure that the drive is correctly installed and wired. (The Stop Input, TB3-7 and TB3-8, must be jumpered together to start the drive.)	Publication 160-SSC User Manual
4 Ensure that the DeviceNet master and network are installed and functioning by DeviceNet standards.	DeviceNet Cable System Planning and Installation Manual (Publication DN-6.7.2)
5 Remove the Program Keypad Module or Ready/Fault Indicating Panel from the drive.	Chapter 3, Installation and Wiring
6 Set the DeviceNet Module's node address and baud rate. Set the DIP Switches at the back of the module. Switches 1 through 6 set the node address; switches 7 and 8 set baud rate.	Chapter 3, Installation and Wiring
7 Install the DeviceNet module on the drive.	Chapter 3, Installation and Wiring
8 Wire the DeviceNet connector and plug it into the drive.	Chapter 3, Installation and Wiring
9 Power up the drive and the network. Important: When power-up occurs, the COMM (communication status) LED flashes green for 1/4 second, red for 1/4 second, and then goes blank while the Communication Module finishes its initialization. If the COMM LED goes red, there is a problem.	Chapter 3, Installation and Wiring, Chapter 4, Modes of Operation, and Chapter 7, Troubleshooting
10 Select the appropriate Electronic Data Sheet (EDS) file. Select the EDS file with the DeviceNet software or hardware configurator that you are using to configure the Communication Module (see Chapter 5 for EDS file descriptions).	Chapter 6, Using 160-DN2 with DeviceNet Scanner, and DeviceNet Software or Hardware Configurator Manual
11 Configure the Bulletin 160 SSC drive for DeviceNet so that the drive can accept speed reference and control logic via the network. Use configuration software such as RSNetWorx for DeviceNet or hardware such as DeviceView Hand Held DeviceNet Configurator.	Chapter 6, Using 160-DN2 with DeviceNet Scanner
12 Configure the DeviceNet Scanner to recognize the Bulletin 160 SSC drive. Use RSNetWorx for DeviceNet to configure the DeviceNet Scanner's "Scan List" to recognize the Bulletin 160 SSC drive.	Chapter 6, Using 160-DN2 with DeviceNet Scanner

Installation and Wiring

This chapter contains information necessary to:

- Meet requirements for CE compliance (EMC / Low Voltage directives).
- Suppress transient EMI from “hard contact” load switching.
- Reduce high frequency common mode noise current.
- Properly connect/disconnect power to the motor.
- Remove a preinstalled Program Keypad Module or Ready/Fault Indicating Panel.
- Configure and install the Communication Module.
- Wire the DeviceNet communication cables.
- Remove an installed Communication Module from the drive.

Read this chapter completely before you attempt to install or configure the Communication Module. Before you apply power, review the [Safety Precautions](#) on Preface [page P-3](#), making sure that all connections are secure and all selections are correct.



ATTENTION: When you make changes to the switch settings, use a blunt pointed instrument. Do not use a pencil or pen because damage may occur.



ATTENTION: Unpredictable operation may occur if you fail to check connections and DIP switch settings for compatibility with your application. Unpredictable operation may result in personal injury, death, and equipment damage.

Required Tools and Equipment

Before installing and configuring the 160-DN2 Communication Module, make sure that the contents of the shipping box include:

- Bulletin 160-DN2 module (Catalog Number 160-DN2)
- 10 pin linear Plug (Part Number 1787-PLUG10R)
- this manual

In addition, you will need to supply:

- a small blade screwdriver
- DeviceNet configuration software or hardware device
- DeviceNet thick cable or thin cable. For details and part numbers, refer to the *DeviceNet Product Overview*, Publication DN-2.5.

EMC Directive 89/336/EEC Compliance

The 160-DN2 Communication Module complies with Electromagnetic Compatibility (EMC) Directive 89/336/EEC when conforming to these installation requirements:

- Applying the essential requirements for a conforming EMC installation for the Bulletin 160 SSC drive. Refer to the *Bulletin 160 SSC User Manual*.
- Connecting the DeviceNet cable shield to the SSC drive's protective earth terminal, PE, with a low impedance connection.
- Installing a clamp-on ferrite cable clamp (see [Figure 3.9](#)) on the DeviceNet communication cable within 10 cm (4 in.) of the SSC drive. When multiple SSC drives are contained in one control cabinet, it is sufficient to install one clamp-on ferrite cable clamp where the DeviceNet communication cable enters the control cabinet.

Low Voltage Directive 73/23/EEC Compliance

The 160-DN2 Communication Module complies with Low Voltage Directive 73/23/EEC when conforming to these installation requirements:

- Applying the essential requirements for a conforming Low Voltage Directive installation for the Bulletin 160 SSC drive. Refer to the *Bulletin 160 SSC User Manual*.
- Observing the [Safety Precautions](#) on Preface [page P-3](#), and other Attention statements throughout this manual when installing the module.

Surge Suppression

Transient EMI can be generated whenever inductive loads such as relays, solenoids, electro-mechanical brakes, motor starters, or motors are operated by "hard contacts." The wiring guidelines contained herein are based on the assumption that you safeguard your system against the effects of transient EMI by using surge suppressors to suppress transient EMI at its source. Inductive loads switched by only solid-state output devices do not require surge suppression. However, inductive loads that are in series or parallel with hard contacts require surge suppression to protect control circuits as well as to suppress transient EMI.

Even if regularly cycled inductive loads have no interaction with the control system, these loads need suppression if their conductors are:

- Connected to the same separately derived system as that of the control system.
- Routed in proximity with conductors of the control system (per routing guidelines).

The application (voltage and load of the inductive circuit) dictates the specific suppressor needed at the source of the inductive load. Testing has determined that the best overall RC surge suppressor combination

is 220 ohms and 0.50 microfarads. Select the voltage rating for the normal AC voltages. A typical surge suppressor that can be used for most transient EMI problems is Electrocube part number RG1676-16 (rated 480V ac).

Surge suppressors are usually most effective when connected at the inductive loads. However, you can also connect surge suppressors at the switching devices, but they may be less effective because the wires connecting the switching devices to the inductive loads act as antennas that radiate EMI. You can evaluate the effectiveness of a particular suppressor by using an oscilloscope to observe the voltage waveform on the line.

Figure 3.1
Surge Suppressor Connection for 3-Phase Apparatus

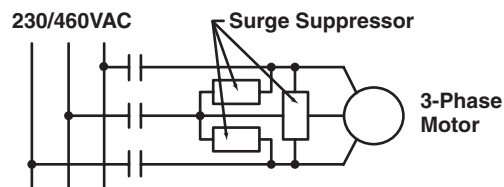

For 3-phase apparatus, a suppressor is needed across each phase

Figure 3.2
Surge Suppressor Connection for Large Apparatus

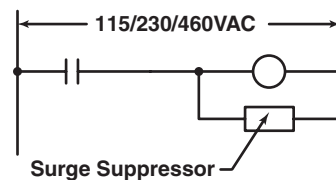

For large apparatus (electro-mechanical brakes, contacts up to size 5)

Figure 3.3
Surge Suppressor Connection for Small Apparatus

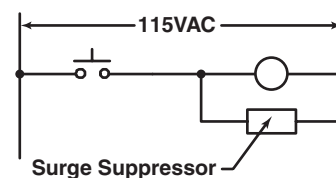

For small apparatus (relays, solenoids, and motor starters up to size 1)

Common Mode Noise

To greatly reduce high frequency common mode noise current coupled to ground in high capacitance connections, connect a common mode choke at the drive end of the motor cable. The common mode choke reduces the rise time of the high frequency noise by a factor of 10-20, and the amplitude by a factor of 5. For multiple 460 volt drive installations with sensitive equipment (e.g. PLC's, temperature sensors, sonar detectors, strain gauges, etc.) sharing a common ground separated by more than 30 feet, you must install common mode chokes at the outputs of each drive.

In addition to greatly reducing high frequency common mode noise induced by the drive, a common mode choke also effectively reduces high frequency common mode noise that is induced by regularly cycled inductive loads. In installations where inductively-coupled common mode noise causes system problems, connect a common mode choke at the source of the inductively-switched load.

For drives on a DeviceNet network, we highly recommend connecting a common mode choke at the drive end of the motor cable.

Drive Output Disconnect

The drive is intended to be commanded by control signals that will start and stop the motor. Do not use a device that routinely connects or disconnects output power to the motor with the drive outputting power (for the purpose of starting and stopping the motor, or for machine positioning). Connecting or disconnecting power to the motor with the drive outputting power can produce transient EMI which can cause network problems to occur.

For emergency stop conditions, make sure that terminal 7 and 8 on TB2 is broken (opened) using an auxiliary contact of a motor output contactor. Also, remember to set the Stop Select parameter to "Coast to Stop."

Removing Program Keypad Module or Ready/Fault Panel

Before installing the Communication Module, it may be necessary to remove a previously installed module such as a Program Keypad Module or Ready/Fault Indicating panel.



ATTENTION: Risk of injury or death exists. The drive contains high voltage capacitors which take time to discharge after removal of mains supply. Before installing or removing the DeviceNet Communication Module, make sure to isolate the mains supply from line inputs [L1, L2, L3 (R, S, T)]. Wait three minutes for capacitors to discharge to safe voltage levels. Failure to do this may result in injury or death.

Figure 3.4
Removing Program Keypad Module

Insert a small screw driver into the slot, pry back, and pivot module out. Avoid bending or twisting the contact pins located underneath the center portion of the module.

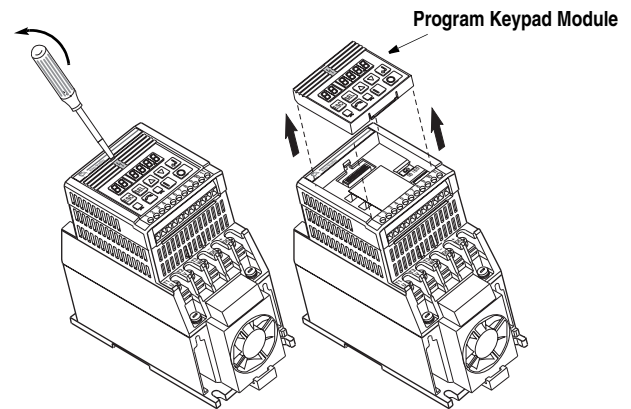

Understanding Module Configuration Switches

The Communication Module's DIP switch settings determine:

- DeviceNet node address
- DeviceNet baud rate

The location of the DIP switch and the factory defaults are shown below.

Figure 3.5
DIP Switches on Rear of Module

DIP Switch ON = 1
Factory Settings OFF = 0

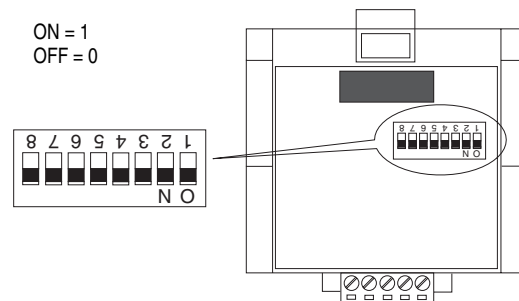

Important: When setting the Communication Module's *addressing* DIP Switches, make sure that each serial device on the network has a unique address. Also, all devices connected to the network must be set at the same baud rate.

Setting the DeviceNet Node Address

DIP switches 6 through 1 set the module's node address using binary addressing. The factory default setting is DeviceNet address 63.

Figure 3.6
Setting the Node Address

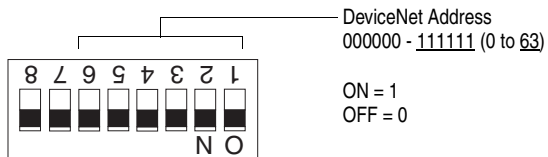

To set the DeviceNet node address:

1. Refer to [Table 3.A](#) below for the switch settings of a specific address.
2. Using a pointed tool, slide switches 6 through 1 to the appropriate ON/OFF positions.

Important: When switches 7 and 8 are ON, the DeviceNet address is set to the value in parameter **P103** - [NV MAC ID].

Table 3.A Switch Settings for DeviceNet Node Addressing

DeviceNet Address	Switch Settings 6 <---- 1	DeviceNet Address	Switch Settings 6 <---- 1	DeviceNet Address	Switch Settings 6 <---- 1	DeviceNet Address	Switch Settings 6 <---- 1
0	000000	16	010000	32	100000	48	110000
1	000001	17	010001	33	100001	49	110001
2	000010	18	010010	34	100010	50	110010
3	000011	19	010011	35	100011	51	110011
4	000100	20	010100	36	100100	52	110100
5	000101	21	010101	37	100101	53	110101
6	000110	22	010110	38	100110	54	110110
7	000111	23	010111	39	100111	55	110111
8	001000	24	011000	40	101000	56	111000
9	001001	25	011001	41	101001	57	111001
10	001010	26	011010	42	101010	58	111010
11	001011	27	011011	43	101011	59	111011
12	001100	28	011100	44	101100	60	111100
13	001101	29	011101	45	101101	61	111101
14	001110	30	011110	46	101110	62	111110
15	001111	31	011111	47	101111	63	111111

Setting the Baud Rate

Dip switches 7 and 8 set the baud rate at which the Communication Module communicates on the network. The factory default setting for baud rate is 125 kbps.

Figure 3.7
Setting the Baud Rate

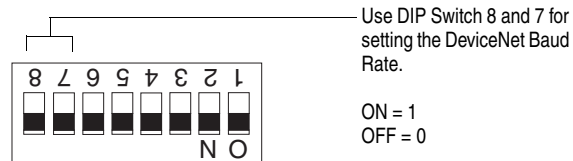

To set the DeviceNet Baud Rate:

1. Refer to [Table 3.B](#) for the switch setting of a specific Baud Rate.
2. Slide switches 7 and 8 to the appropriate positions using a pointed tool.

Important: When switches 7 and 8 are ON, the DeviceNet Baud Rate is set to the value in parameter **P104 - [NV Baud Rate]**.

Table 3.B Switch Settings for DeviceNet Module Baud Rate

Baud Rate	Switch Setting 8	Switch Setting 7
125 kbps	0	0
250 kbps	0	1
500 kbps	1	0
Set by module parameter P104	1	1

Cable Lengths and Baud Rates

The baud rate determines the maximum length of the DeviceNet cable. Refer to [Table 3.C](#) to determine cable lengths and baud rates.

Table 3.C Baud Rate vs. Cable Length

Baud Rate	Maximum Cable Length (Trunk Line)
125 kbps	500 meters (1640 feet)
250 kbps	250 meters (820 feet)
500 kbps	100 meters (328 feet)

Installing the Communication Module

After setting the DIP switches, secure the Communication Module to the drive by following these steps:

1. Insert the module, ensuring that the pins on the back of the module line up with the drive's expansion port.
2. Press down on the module until it is fully seated. The module is fully seated when its sides are resting on the drive's face.
3. Press down on the latch until it snaps into place.

Figure 3.8
Installing the Communication Module

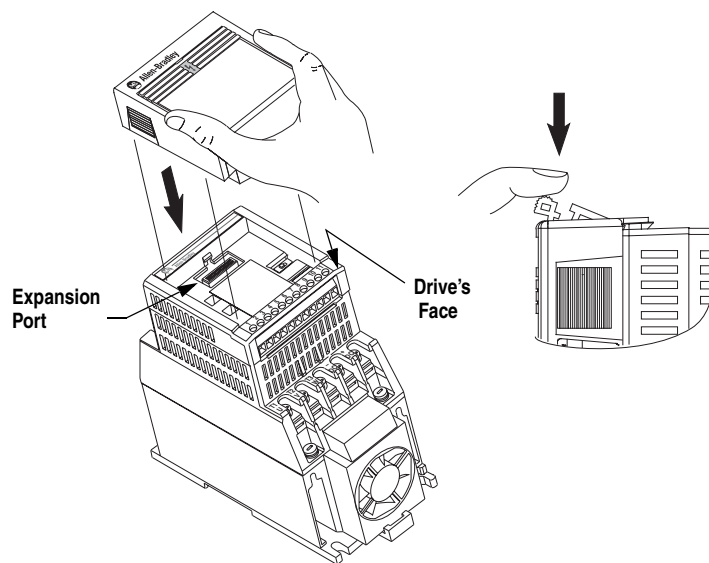

Wiring the DeviceNet Connector

Follow these recommendations for communications wiring:

- See *DeviceNet Cable System Planning and Installation Manual*, Publication DN-6.7.2, for planning and installing DeviceNet networks.
- Keep communication wiring away from high noise sources such as motor cables.
- Increase noise immunity by:
 - Using a trunk line in place of a drop line.
 - Using a ferrite cable clamp around the communication line (see [Figure 3.9](#)).
 - Grounding the cable shield as shown in [Figure 3.9](#).

Figure 3.9
Wiring the DeviceNet 10-Pin Linear Plug

The Communication Module receives power and communications through the DeviceNet connector. DeviceNet cable wires connect to the DeviceNet plug as shown below:

Color	Terminal	Signal	Function
Black	1	COMM	Common
Blue	2	CAN_L	Signal Low
Bare	3	SHIELD	Shield
White	4	CAN_H	Signal High
Red	5	VDC+	Power Supply

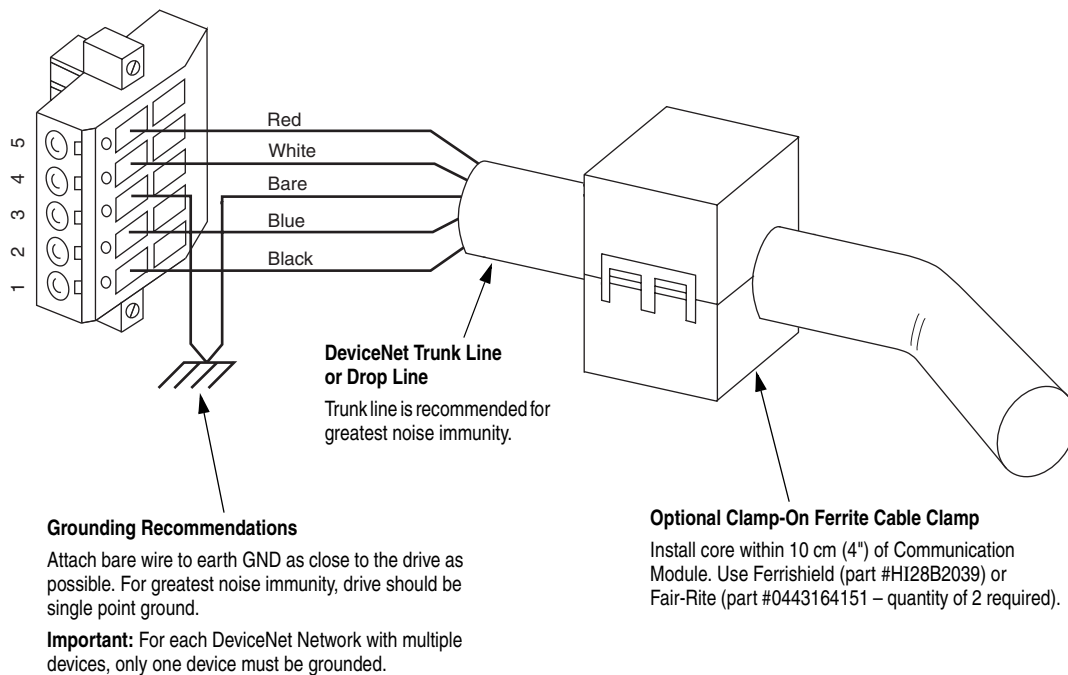

Connecting the DeviceNet Drop Line to the Module

To connect your module DeviceNet drop line:

1. Turn off the network power supply.



ATTENTION: Do not wire the Communication Module with the network power supply on. Wiring the module with the network power supply on may short your network or disrupt communication.

2. Make sure that the DeviceNet 10-pin Linear Plug is correctly wired (see [Figure 3.9](#)).
3. Locate the DeviceNet connector on the bottom of the module.
4. Insert the plug into the DeviceNet connector.

Figure 3.10
Installing the Drop Line

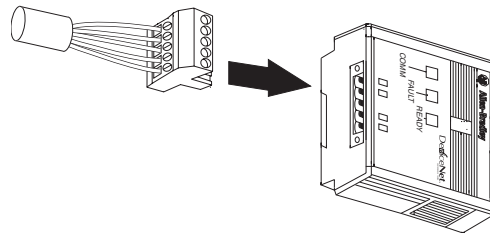

Removing Communication Module From a Drive

If you need to reconfigure the Communication Module DIP switches, you must remove the Communication Module from the drive.

1. Remove the DeviceNet plug from the Communication Module.
2. Press in on the module's latch and then push away and up.
3. Grasp the module and pull straight up. Avoid bending or twisting the contact pins located underneath the center portion of the module.

Figure 3.11
Removing the Communication Module

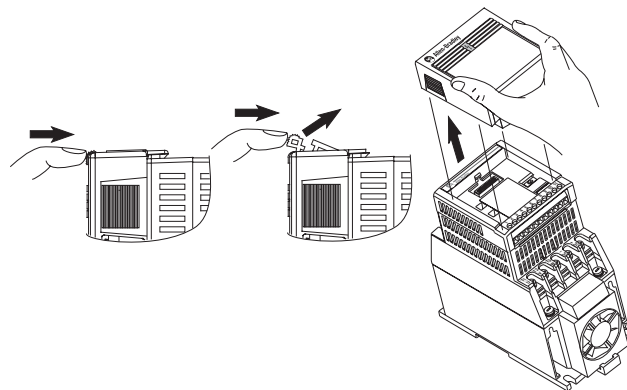

Modes of Operation

This chapter contains information about:

- Powering up the drive with an installed 160-DN2 DeviceNet communication module.
- Understanding the module's modes of operation.

Before you apply power, review the [Safety Precautions](#) on Preface page P-3.

Powering Up the Drive

After you have installed the 160-DN2 module, apply power to the drive and to the Network. The COMM LED should flash green or turn solid green. If it does not, refer to [Chapter 7, Troubleshooting](#).

Modes of Operation

The 160-DN2 module operating modes are:

- Power-up reset mode
- Run mode
- Error mode

Power-up Reset Mode

During power-up or reset, the COMM LED is off.

The 160-DN2 module follows this sequence of operation:

1. When power-up occurs, the COMM LED flashes green for 1/4 second, red for 1/4 second, and then goes blank while the 160-DN2 module finishes its initialization.
2. Performs power-up initialization.
3. Reads and stores the DIP switch settings.
4. Performs a duplicate node address check to verify that another node is not assigned the same DeviceNet address as the 160-DN2 module.

If the power-up or reset is successful, the 160-DN2 module enters the Run mode and the COMM LED flashes green or turns solid green.

Modes of Operation (Continued)

Power-up Reset Mode (Continued)

If the power up or reset sequence fails, the COMM LED will turn solid red and the 160-DN2 module will enter the Error mode (see heading below for more information).

Table 4.A COMM LED State During Power-up Reset Mode

COMM LED State	Description
Flashes Green 1/4 second, Red 1/4 second, then goes blank	Occurs when power is applied to module.
Blank	Power-up initialization is taking place.
Solid Red	160-DN2 module is in Error mode. Indicates failed initialization, duplicate node address or incorrect baud rate.
Solid Green	160-DN2 module is in the Run mode.

Run Mode

After a successful power-up or reset, the 160-DN2 module enters the run mode and operates as a slave device to a master device. In run mode, the module:

- Accepts messages from the master on the DeviceNet network.
- Monitors DeviceNet incoming power.

If an error is detected, the 160-DN2 module will enter the Error mode (see heading below for more information).

Error Mode

If the 160-DN2 module detects an error, the COMM LED is affected. Errors are critical or noncritical, and are summarized below.

Table 4.B COMM LED State During Error Mode

COMM LED State	Error Type	Description
Solid Red	Critical (not recoverable)	Power-up initialization failure.
		Duplicate node address detected.
		Incorrect baud rate.
Flashing Red	Non-Critical (recoverable)	I/O connection timed out.
Off	Non-Critical (recoverable)	DeviceNet power lost.

See [Chapter 7, Troubleshooting](#) for details in the troubleshooting chart on how to recover from an error.

DeviceNet Parameter Descriptions

This chapter contains:

- a description of DeviceNet parameters
- the definition of Electronic Data Sheet (EDS) files
- *Bulletin 160 SSC Interface* parameters
- brief description of Bulletin 160 parameters

Important: This chapter describes the parameter set for a Series C Bulletin 160. If you are using a Series A or Series B Bulletin 160, not all the parameters listed in this manual may apply to that drive. When using a Series A Bulletin 160, please refer to the *Bulletin 160 SSC User Manual*, Publication 0160-5.0. When using a Series B Bulletin 160, please refer to the *Bulletin 160 SSC User Manual*, Publication 0160-5.9.

DeviceNet Parameters

The 160-DN2 communication module contains a set of parameters that define how the module will interact with the Bulletin 160 SSC drive and the DeviceNet network. These parameters may be used to set the module's address, baud rate, and I/O data format. Parameters may also be read to attain status from the module.

Electronic Data Sheet (EDS) Files

EDS files are specially formatted ASCII files that provide all of the information necessary for a configuration tool such as RSNetWorx for DeviceNet to access and alter the parameters of a device. The EDS file contains information on the number of parameters in a device and how those parameters are grouped. Additionally, the EDS file contains information about each parameter such as parameter min, max, and default values, parameter data format and scaling, and the parameter name and units.

Parameters and EDS File

You select an EDS file for the Bulletin 160 drive using a software application such as RSNetWorx for DeviceNet. (See [Chapter 6, Using 160-DN2 with DeviceNet Scanner](#), for instructions to select an appropriate EDS file.) An EDS file defines all the parameters in the Bulletin 160 drive and the 160-DN2 module, and creates a public interface to the drive on the DeviceNet network. Configuration tools such as RSNetWorx for DeviceNet use EDS files to present you with parameters that enable you to configure the 160 SSC drive via DeviceNet by changing values associated with individual parameters.

Parameters and EDS File (Continued)

Parameter values may be read or written via DeviceNet. *Writing* a value to a parameter may configure drive operations such as acceleration or deceleration rates. Writing a value to a parameter may also configure DeviceNet operations such as which input or output assemblies are to be used for polled I/O communications with a master. *Reading* a parameter value gives you status information.

Bulletin 160 SSC Interface

This parameter set contains all of the parameters described in the *Bulletin 160 SSC User Manual*, plus a few extra parameters to configure the operation of the 160-DN2 module on the DeviceNet network.

Locating EDS Files on the Internet

Bulletin 160 SSC drives are available in Analog Signal Follower and Preset Speed models. Each model supports a slightly different set of parameters. (In general, the Preset Speed model contains extra parameters for setting up preset speeds.) Accordingly, each drive model uses an EDS file specific to that model.

You can find the EDS file for your drive at <http://www.ab.com/networks/eds>. Select the search criteria for the EDS file to be the same as that shown in the screen below.

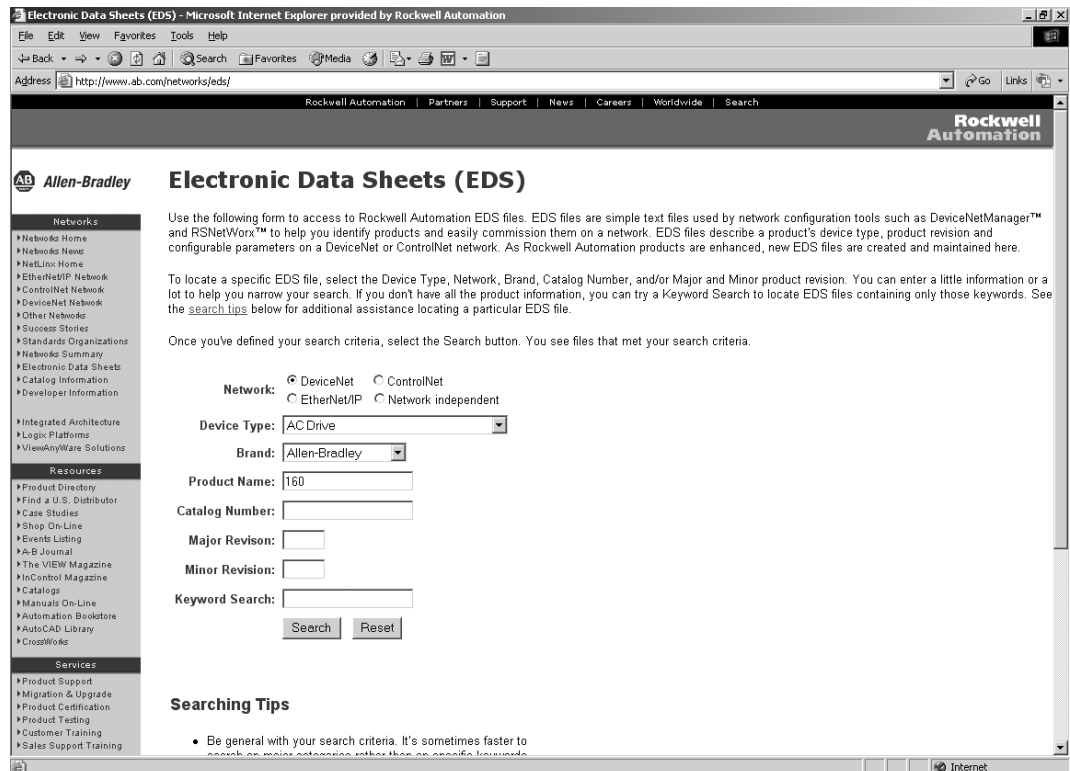

Electronic Data Sheets (EDS)

Use the following form to access to Rockwell Automation EDS files. EDS files are simple text files used by network configuration tools such as DeviceNetManager™ and RSNetWorx™ to help you identify products and easily commission them on a network. EDS files describe a product's device type, product revision and configurable parameters on a DeviceNet or ControlNet network. As Rockwell Automation products are enhanced, new EDS files are created and maintained here.

To locate a specific EDS file, select the Device Type, Network, Brand, Catalog Number, and/or Major and Minor product revision. You can enter a little information or a lot to help you narrow your search. If you don't have all the product information, you can try a Keyword Search to locate EDS files containing only those keywords. See the [search tips](#) below for additional assistance locating a particular EDS file.

Once you've defined your search criteria, select the Search button. You see files that met your search criteria.

Network: DeviceNet ControlNet
 EtherNet/IP Network independent

Device Type:

Brand:

Product Name:

Catalog Number:

Major Revision:

Minor Revision:

Keyword Search:

Searching Tips

- Be general with your search criteria. It's sometimes faster to search by product name rather than by specific keywords.

After the EDS file list appears, find your specific drive in the Product Name column. Then, in the Brand column of that row click on the Allen-Bradley Company link to access the EDS file for downloading.

Important: Use the correct EDS file for your specific drive model, horsepower, and voltage. If an incorrect EDS file is used, you may not be able to set up the drive with the configuration tool.

Bulletin 160 SSC Interface Parameters

The *Bulletin 160 SSC Interface* parameters are grouped together logically. The following sections provide information about the *Bulletin 160 SSC Interface* parameter groups:

- DeviceNet Parameters
- Drive Display Parameters
- Drive Program Parameters

The following parameter lists summarize the *Bulletin 160 SSC Interface*. For more detailed information on the Display Group and Program Group parameters, see the *Bulletin 160 SSC User Manual*.

Important: The following information contains object mapping data, which is needed when using Explicit Messaging. Refer to *Chapter 6, Page 6-23*, for more information.

DeviceNet Parameters

Use the following parameters to configure and monitor the DeviceNet Network Interface. These parameters are unique to drives equipped with the 160-DN2 DeviceNet Communication Module.

Parameter Number	Name and Description	Object Mapping (Class-Instance-Attribute)	Min./Max. Range	Factory Default
101	[Switches MAC ID] This read only parameter displays the state of the Node Address DIP switches. This address may not be the current address of the module if the Baud Rate DIP switches are set to 3. In this case P103 - [NV MAC ID] is used.	0xB4-1-3	0 to 63	63
102	[Switches Baud] This read only parameter displays the state of the Baud Rate DIP switches. A value of 3 means that the actual baud rate used by this module is given in the value of P104 - [NV Baud Rate] . 0 = 125 kbps 1 = 250 kbps 2 = 500 kbps 3 = Use nonvolatile parameters for Address and Baud.	0xB4-1-4	0 to 3	0
103	[NV MAC ID] This read/write parameter enables you to program the Node Address of the module independent of the DIP switch settings. To use this feature, set the baud rate DIP switches (7 and 8) to ON before power-up. Changing this parameter does not change the actual node address until power is cycled.	0xB4-1-5	0 to 63	63
104	[NV Baud Rate] This read/write parameter enables you to set the baud rate of the module without having to set the DIP switches. To use this feature, set the baud rate switches (7 and 8) to ON before power up. Changing this parameter does not change the actual data rate until power is cycled. 0 = 125 kbps 1 = 250 kbps 2 = 500 kbps	0xB4-1-6	0 to 2	0
105	[Bus Off Error] This read/write parameter determines how the Communication Module processes a <i>CAN Bus Off</i> condition. 0 = Hold CAN chip in its bus off (reset) state when bus off is detected. 1 = If possible, fully reset the CAN chip and continue communicating when a bus off condition is detected.	0x03-1-3	0 to 1	0

DeviceNet Parameters (Continued)

Parameter Number	Name and Description	Object Mapping (Class-Instance-Attribute)	Min./Max. Range	Factory Default
106	<p>[Bus Off Count] This read/write parameter counts the number of times the CAN chip went to the <i>bus off</i> state. This counter stops counting when the count reaches 255. Any write to this parameter will reset the counter to 0.</p>	0x03-1-4	0 to 255	0
107	<p>[Output Assembly] This read/write parameter sets the output assembly instance that is to be used for <i>polled</i> messaging with the master. The output assembly defines the data format that the drive receives from the master. The name (output assembly) is somewhat misleading in that this parameter determines the format of data being sent to the drive by the master. It is named <i>output assembly</i> because the DeviceNet specification refers to all assemblies as they relate to the master. The following assembly instances are valid for this parameter:</p> <ul style="list-style-type: none"> 0 = No Data 1 = Basic Contactor Output 2 = Two Command Contactor Output 3 = Basic Overload Output 4 = Basic Motor Control Output 5 = 2 Command Motor Control 20 = Basic Speed Control 21 = Extended Speed Control 100 = Speed Control in Hz 101 = Preset Control (for Preset Speed units only) 103 = Allen-Bradley Drive Assembly <p>Important: See <i>Appendix B</i>, pages B-24 to B-25 for the formats of the output assembly.</p>	0x29-1-100	0 to 103	20
108	<p>[Input Assembly] This read/write parameter sets the input assembly instance that is to be used for <i>polled</i> messaging with the master. The input assembly defines the data format that the drive sends to the master in response to a polled message from the master. The name (input assembly) is somewhat misleading in that this parameter determines the format of data being sent to the master. It is named input assembly because the DeviceNet specification refers to all assemblies as they relate to the master. The following assembly instances are valid for this parameter:</p> <ul style="list-style-type: none"> 0 = No Data 50 = Basic Overload Input 51 = Extended Overload Input 52 = Basic Motor Control Input 53 = Extended Motor Control Input 54 = Extended Motor Control 2 70 = Basic Speed Control Input 71 = Extended Speed Control Input 102 = Custom Parameter Based Assembly 104 = Allen-Bradley Drive Assembly 105 = Allen-Bradley Drive Assembly with Parameters <p>Important: See <i>Appendix B</i>, pages B-26 to B-28 for the formats of the input assembly.</p>	0x29-1-101	0 to 105	70
109	<p>[Assembly Word 0] This read/write parameter is used when P108 - [Input Assembly] is set to 102 Custom Parameter Based Assembly. It defines the first word in an assembly built from Bulletin 160 parameters. A 0 value defines the end of the assembly. For more information, see <i>Appendix B</i>, page B-27.</p>	0xB4-1-7	0 to 88	9

DeviceNet Parameters (Continued)

Parameter Number	Name and Description	Object Mapping (Class-Instance-Attribute)	Min./Max. Range	Factory Default
110	<p>[Assembly Word 1] This read/write parameter is used when P108 - [Input Assembly] is set to 102 Custom Parameter Based Assembly. It defines the second word in an assembly built from Bulletin 160 parameters. A 0 value defines the end of the assembly. For more information, see <i>Appendix B</i>, page B-27.</p>	0xB4-1-8	0 to 88	0
111	<p>[Assembly Word 2] This read/write parameter is used when P108 - [Input Assembly] is set to 102 Custom Parameter Based Assembly, or 105 Allen-Bradley Drive Assembly with Parameters. It defines the third word in an assembly built from Bulletin 160 parameters. A 0 value defines the end of the assembly. For more information, see <i>Appendix B</i>, page B-27 or B-28.</p>	0xB4-1-9	0 to 88	0
112	<p>[Assembly Word 3] This read/write parameter is used when P108 - [Input Assembly] is set to 102 Custom Parameter Based Assembly, or 105 Allen-Bradley Drive Assembly with Parameters. It defines the fourth word in an assembly built from Bulletin 160 parameters. A 0 value defines the end of the assembly. For more information, see <i>Appendix B</i>, page B-27 or B-28.</p>	0xB4-1-10	0 to 88	0
113	<p>[DN Fault Mode] This read/write parameter determines the drive's behavior when a communication fault such as loss of DeviceNet power occurs. The behavior choices are: 0 = Fault the drive and issue a stop command 1 = Ignore the communication fault</p> <hr/> <p> ATTENTION: Ignoring communication faults may result in equipment damage, personal injury, or death. Make sure you understand how ignoring a communication fault affects the operation of your system.</p>	0x29-1-16	0 to 1	0
114	<p>[Motor Base RPM] This read/write parameter is set to the motor's rated nameplate speed in RPM.</p>	0x28-1-15	200 to 32000	1800 RPM
115	<p>[DNet Idle Mode] This Parameter controls the action of the drive when the Scanner is in Idle Mode. 0 = Stop if Idle Mode (default) 1 = Hold last state if Idle Mode</p>	0xB4-1-11	0 to 1	0
116	<p>[DNet SW Version] This read only parameter indicates the software version of the DeviceNet option. The number is shown in the format xx.yy where xx denotes the major revision level and yy denotes the minor revision level.</p>	0xB4-1-12	0.00 to 10.00	3.01
117	<p>[COS Mask] This parameter is a 16-bit mask used to enable automatic change of state messages. A 0 disables the indicated status from causing an automatic message. A 1 enables the status. The mask is applied to the defined input status assembly. The default value is 0xFFFF.</p>	0xB4-1-13	0 to 0xFFFF	0xFFFF
118	<p>[Local Return Md] This parameter sets the input mode the drive will use when transitioning from network to local control. This is only used with input mode 2. Available values are 0, 1, 3, 4, and 5.</p>	0xB4-1-14	0 to 9	0

Drive Display Parameters (Read Only)

Below is a brief description of the *Bulletin 160 SSC Interface Display* Group parameters. Refer to the *Bulletin 160 SSC User Manual* for more detailed information on these parameters.

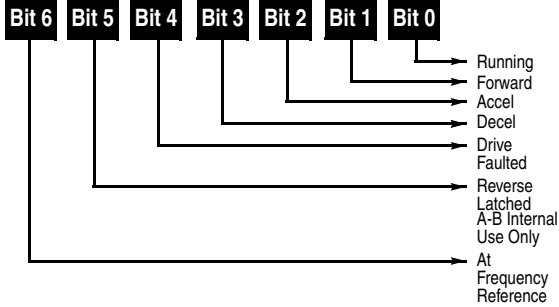
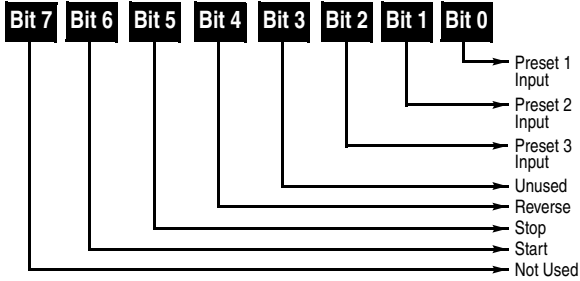
Parameter Number	Parameter Name	Object Mapping (Class-Instance-Attribute)	Description	Units
01	[Output Frequency]	0xB3-1-1	Frequency at TB2 terminals T1, T2, T3.	0.1 Hz
02	[Output Voltage]	0xB3-1-2	Voltage at TB2 terminals T1, T2, T3.	1 Volt
03	[Output Current]	0xB3-1-3	Current at TB2 terminals T1, T2, T3.	0.01 Amperes
04	[Output Power]	0xB3-1-4	Power at TB2 terminals T1, T2, T3.	0.01 kW
05	[Bus Voltage]	0xB3-1-5	DC Bus voltage level.	1 Volt
06	[Cmd Frequency]	0xB3-1-6	Commanded Frequency.	0.1 Hz
07	[Present Fault]	0xB3-1-7	Coded last fault number.	Numeric Value
08	[Heatsink Temp]	0xB3-1-8	Temperature of the drive heatsink.	1 degree C
09	[Drive Status]	0xB3-1-9	Status of drive in binary coded format. Important: Parameter 9 shown below <i>does not</i> match what is published in the Bulletin 160 SSC User Manual. The DeviceNet binary code for Parameter 9 is: 	Binary Number
10	[Drive Type]	0xB3-1-10	Used by Allen-Bradley field service personnel.	Numeric Value
11	[Firmware Version]	0xB3-1-11	Version of drive firmware used.	Numeric Value
12	[Input Status] ①	0xB3-1-12	Open (0) Closed (1) state of Drive's discrete inputs. Important: Parameter 12 shown below <i>does not</i> match what is published in the Bulletin 160 SSC User Manual. The DeviceNet binary code for Parameter 12 is: 	Binary Number
13	[Power Factor Ang]	0xB3-1-13	Angle (electrical degrees) between V and I.	0.1 degree C
14	[Memory Probe]	0xB3-1-14	Used by Allen-Bradley service personnel.	Numeric Value

① For preset speed model, this parameter contains the data from parameter 15 in the SSC drive due to conflicting parameter numbers with DeviceNet specific parameters.

Drive Display Parameters (Read Only) (Continued)

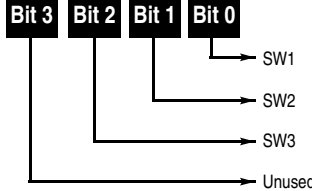

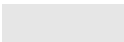
Parameter Number	Parameter Name	Object Mapping (Class-Instance- Attribute)	Description	Units
15	[Preset Status]	0xB3-1-15	Open (0) and closed (1) state of TB3 inputs SW1, SW2, and SW3. 	Binary Number
16	[Analog Input]	0xB3-1-16	The analog input as a percent of full scale.	0.1%
17	[Fault Buffer 0]	0xB3-1-17	Most recent fault.	Numeric Value
18	[Fault Buffer 1]	0xB3-1-18	Second most recent fault.	Numeric Value
19	[Fault Buffer 2]	0xB3-1-19	Third most recent fault.	Numeric Value

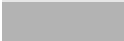
 This parameter applies only to the Analog Signal Follower model.

 This parameter applies only to the Preset Speed model.

Drive Program Parameters

Below is a brief description of the *Bulletin 160 SSC Interface* Program Group parameters. Refer to the *Bulletin 160 SSC User Manual* for more detailed information on these parameters.

Parameter Number	Parameter Name	Object Mapping (Class-Instance-Attribute)	Description	Units
30	[Accel Time 1]	0xB3-1-30	Time to ramp from 0 Hz to maximum frequency.	0.1 Seconds
31	[Decel Time 1]	0xB3-1-31	Time to ramp from maximum frequency to 0 Hz.	0.1 Seconds
32	[Minimum Frequency]	0xB3-1-32	Lowest continuous output frequency.	1 Hz
33	[Maximum Frequency]	0xB3-1-33	Highest continuous output frequency.	1 Hz
34	[Stop Mode Select]	0xB3-1-34	Determines stop mode used.  ATTENTION: Changing this parameter value may cause unpredictable network conditions, resulting in equipment damage, personal injury, or death. Make sure that you understand how changing this parameter affects your application.	Numeric Value
35	[Base Frequency]	0xB3-1-35	Set to motor's nameplate frequency.	1 Hz
36	[Base Voltage]	0xB3-1-36	Set to motor's nameplate voltage.	1 Volt
37	[Maximum Voltage]	0xB3-1-37	Highest voltage the drive will output.	1 Volt
38	[Boost Select]	0xB3-1-38	Sets the volts/Hz relationship.	Numeric Value
39	[Skip Frequency]	0xB3-1-39	Frequency at which drive will not run continuously.	1 Hz
40	[Skip Freq Band]	0xB3-1-40	Used with P39 - [Skip Frequency] to create skip band.	1 Hz
41	[Overload Select]	0xB3-1-41	Selects derating factor for motor overload.	Numeric Value
42	[Motor Overload]	0xB3-1-42	Set to motor nameplate full load amperes.	0.01 Amperes
43	[Current Limit]	0xB3-1-43	Max output current allowed before limiting.	% I rating
44	[DC Hold Time]	0xB3-1-44	DC Injection Braking duration.	0.1 Seconds
45	[DC Hold Voltage]	0xB3-1-45	Voltage level for DC Injection Braking.	1 Volt
46	[Input Mode]	0xB3-1-46	Type of START, STOP, REV, commands.  ATTENTION: Changing this parameter value may cause unpredictable network conditions, resulting in equipment damage, personal injury, or death. Make sure that you understand how changing this parameter affects your application.	Numeric Value
47	[Output Configure]	0xB3-1-47	Configures TB3 output relay functionality.	Numeric Value
48	[Output Threshold]	0xB3-1-48	Used in conjunction with P47 - [Output Configure] .	Numeric Value
49	[PWM Frequency]	0xB3-1-49	Carrier frequency for PWM output waveform.	0.1 kHz
50	[Restart Tries]	0xB3-1-50	Times drive will attempt to reset a fault.	Numeric Value
51	[Restart Time]	0xB3-1-51	Time between restart attempts.	0.1 Seconds
52	[DB Enable]	0xB3-1-52	Enables/disables dynamic braking.	Numeric Value
53	[S-Curve]	0xB3-1-53	Enables a fixed shape S-curve.	Numeric Value

Drive Program Parameters (Continued)

Parameter Number	Parameter Name	Object Mapping (Class-Instance-Attribute)	Description	Units
54	[Clear Fault]	0xB3-1-54	Setting to 1 performs a fault reset.	Numeric Value
55	[Probe Address]	0xB3-1-55	Used by Allen-Bradley service personnel.	Numeric Value
56	[Reset Functions]	0xB3-1-56	Sets all parameters to their factory default.	Numeric Value
57	[Program Lock]	0xB3-1-57	Locks all program group parameters.	Numeric Value
58	[Internal Freq]	0xB3-1-58	Digital frequency setpoint.	0.1 Hz
59	[Freq Select]	0xB3-1-59	Selects source of Frequency command.	Numeric Value
60	[Zero Offset]	0xB3-1-60	Add or subtracts an offset to the analog input.	Numeric Value
60	[DN Preset Cmd]	0xB3-1-92	Network preset command.	Numeric Value
61	[Preset Freq 0]	0xB3-1-61	Sets command frequency when selected.	0.1 Hz
62	[Preset Freq 1]	0xB3-1-62	Sets command frequency when selected.	0.1 Hz
63	[Preset Freq 2]	0xB3-1-63	Sets command frequency when selected.	0.1 Hz
64	[Preset Freq 3]	0xB3-1-64	Sets command frequency when selected.	0.1 Hz
65	[Preset Freq 4]	0xB3-1-65	Sets command frequency when selected.	0.1 Hz
66	[Preset Freq 5]	0xB3-1-66	Sets command frequency when selected.	0.1 Hz
67	[Preset Freq 6]	0xB3-1-67	Sets command frequency when selected.	0.1 Hz
68	[Preset Freq 7]	0xB3-1-68	Sets command frequency when selected.	0.1 Hz
69	[Accel Time 2]	0xB3-1-69	Sets second acceleration rate.	0.1 Seconds
70	[Decel Time 2]	0xB3-1-70	Sets second deceleration rate.	0.1 Seconds
71	[IR Compensation]	0xB3-1-71	Adds a voltage to the output based on the torque current.	1%
72	[Slip Comp]	0xB3-1-72	Compensates for the inherent slip of the motor.	0.1 Hz
73	[Reverse Disable]	0xB3-1-73	Setting to 1 disables the reverse.	Numeric Value
74	[Analog Select]	0xB3-1-74	Selects between unipolar and bipolar analog input.	Numeric Value
75	[Analog Minimum]	0xB3-1-75	Sets the percent of the analog input used to represent P32 - [Minimum Frequency] .	0.1%
76	[Analog Maximum]	0xB3-1-76	Sets the percent of the analog input used to represent P33 - [Maximum Frequency] .	0.1%
78	[Compensation]	0xB3-1-78	Some drive/motor combinations have inherent instabilities which are exhibited as non-sinusoidal motor currents. A setting of 1 will enable the compensation to correct this condition. A setting of 0 disables this function.	Numeric Value
79	[Curent Trip]	0xB3-1-79	Percent above P43 - [Current Limit] at which the drive trips immediately.	1%

This parameter applies only to the Analog Signal Follower model.

This parameter applies only to the Preset Speed model.

Drive Program Parameters (Continued)

Parameter Number	Parameter Name	Object Mapping (Class-Instance-Attribute)	Description	Units
80	[Stall Disable]	0xB3-1-80	Amount of time that the drive must be in a stall condition before it causes a stall fault.  ATTENTION: Risk of equipment damage exists. Continuous operation at high currents caused by a stall can cause motor damage.	Numeric Value
81	[Proc Kp Gain]	0xB3-1-81	Proportional gain used by the PI regulator. This parameter is active when P46 - [Input Mode] setting 9 is used.	Numeric Value
82	[Proc Ki Gain]	0xB3-1-82	Integral gain used by the PI regulator. This parameter is active when P46 - [Input Mode] setting 9 is used.	Numeric Value
83	[Proc Reference]	0xB3-1-83	Set point value to which PI control will regulate. This parameter is active when P46 - [Input Mode] setting 9 is used.	Numeric Value
84	[PI Dead Band]	0xB3-1-84	The PI control will ignore errors less than this value. This parameter is active when P46 - [Input Mode] setting 9 is used.	Numeric Value

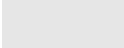
 This parameter applies only to the Analog Signal Follower model.

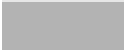
 This parameter applies only to the Preset Speed model.

Using 160-DN2 with DeviceNet Scanner

This chapter provides an overview of how to use the Bulletin 160-DN2 Communication Module with a DeviceNet Scanner. Scanners act as “Masters” on a DeviceNet Network for the I/O communication with a 160-DN2 module. Scanners periodically send I/O messages to a 160-DN2 module at a set frequency, and the module responds to these I/O messages by sending status messages back to the scanner. The scanner also allows a ladder logic program to configure and read parameters from the Bulletin 160 SSC drive through special encoded instructions called Explicit Messages.

This chapter contains information on:

- How to create the EDS file for the 160-DN2 module.
- How to set up the 160-DN2 module on DeviceNet.
- How to select Input and Output Assemblies for I/O messaging.
- How to set up a scanner (1756-DNB, 1771-SDN or 1747-SDN) to work with the 160-DN2 module.
- Sample ladder logic programs for ControlLogix, PLC-5, and SLC controllers to control the Bulletin 160 SSC drive using I/O messaging.
- How to set up Explicit Messaging, and sample ladder logic programs for ControlLogix, PLC-5, and SLC controllers to execute Explicit Messaging.

Before continuing this chapter, we recommend that you read the *RSNetWorx for DeviceNet Getting Results Guide* Online help (installed with the software) and the *DeviceNet Scanner Module Installation Instructions Manual* for the scanner being used. Understanding the concepts in these manuals will be important to using the information in this chapter.

This chapter includes examples for using the 160-DN2 module with a 1756-DNB Scanner/ControlLogix system, 1771-SDN Scanner/PLC-5 system, and 1747-SDN Scanner/SLC system.

Important: All examples in this chapter use a Bulletin 160 SSC Series C preset speed drive, RSLinx Software (version 2.3x or higher), RSNetWorx for DeviceNet Software (version 3.xxx or higher), RSLogix Programming Software and, for ControlLogix, Ethernet via the controller backplane.

Needed Tools

The following tools are needed to set up the 160-DN2 module on a DeviceNet network and operate with a scanner:

- RSLinx Software (version 2.3x or higher)
- RSNetWorx for DeviceNet (version 3.xxx of higher)
- RSLogix Programming Software

Setting Device MAC ID's

Every device on a DeviceNet network must have a unique MAC ID between 0 and 63. Use the network and a configuration tool such as RSNetWorx for DeviceNet to set the MAC ID on the scanner. You can set the MAC ID for the 160-DN2 communication module using this same method or by using its DIP switches. For directions on setting the 160-DN2 module MAC ID, refer to [Chapter 3](#).

Using RSNetWorx for DeviceNet

Going Online

Before starting, make sure to configure the proper driver in RSLinx. If you need further assistance, refer to the online Help in RSLinx.

You can view the devices on a DeviceNet network by going online. A device may appear as an unrecognized device (node 63 in [Figure 6.1](#)) if RSNetWorx for DeviceNet does not have an EDS file for it.



Shortcut to
RSNetWorx

1. After setting up a driver in RSLinx, start RSNetWorx for DeviceNet.
2. Select **Network > Online**. If the Browse for Network dialog box appears, RSLinx has multiple drivers configured. Select your DeviceNet network, and click **OK**. A prompt appears.
3. Click **OK** to go online. The devices on the network appear in the Configuration View. You can select Graph, Spreadsheet or Master/Slave views. [Figure 6.1](#) shows an example network in a Graph view.

Figure 6.1
Example DeviceNet Network in Graph View

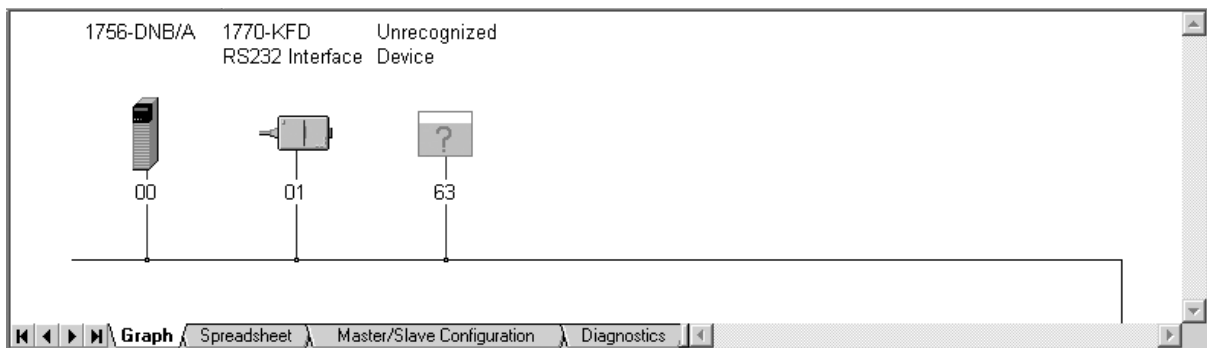

Using RSNetWorx for DeviceNet (Continued)

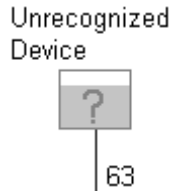

Bulletin 160
Preset 3.7 kW
460v



Creating an EDS File

If the 160-DN2 communication module and Bulletin 160 SSC drive appear as an unrecognized device, create an EDS file for it.

1. Right-click the “Unrecognized Device” icon, and select **Register Device** in the menu. The EDS Wizard ([Figure 6.2](#)) appears.
2. Click **Next** to display the next step.
3. Select **Upload EDS**, and then click **Next**.
4. Type a description (if desired), and then click **Next**.
5. Under Polled, select **Enabled**, type **4** in the Input Size and Output Size boxes, and then click **Next**. RSNetWorx will upload the EDS file from the drive and communication module.
6. Click **Next** to display the icon options for the node. We recommend that you use the icon for your product. You can change icons by clicking **Change Icon**.
7. Click **Next** to view a summary, and then click **Next** again to accept it.
8. Click **Finish** to finish the EDS creation. A new icon represents the drive and 160-DN2 module in the Configuration View.

Figure 6.2
EDS Wizard Screen



Using RSNetWorx for DeviceNet (Continued)

Accessing and Editing Parameters

Parameters in the drive and 160-DN2 module can be edited with RSNetWorx for DeviceNet.

1. After creating an EDS file, right-click on the icon for the Bulletin 160 SSC drive and 160-DN2 module and select **Properties**. The Bulletin 160 Drive dialog box appears.
2. Click the **Parameters** tab (Figure 6.3). If an EDS Editor message appears, click **Upload** to load the parameter values in the drive to the computer.

Parameters are displayed in numerical order under Parameter. You can either scroll through the list, or check the Groups box and select a specific group of parameters. The available groups and the numbers of the module parameters will vary based on the type of drive that is connected to the module.

3. In the Current Value column, double-click a value to edit it.
4. Click **Apply** to save changes to the device.

Figure 6.3
Example Bulletin 160 Drive Dialog Box

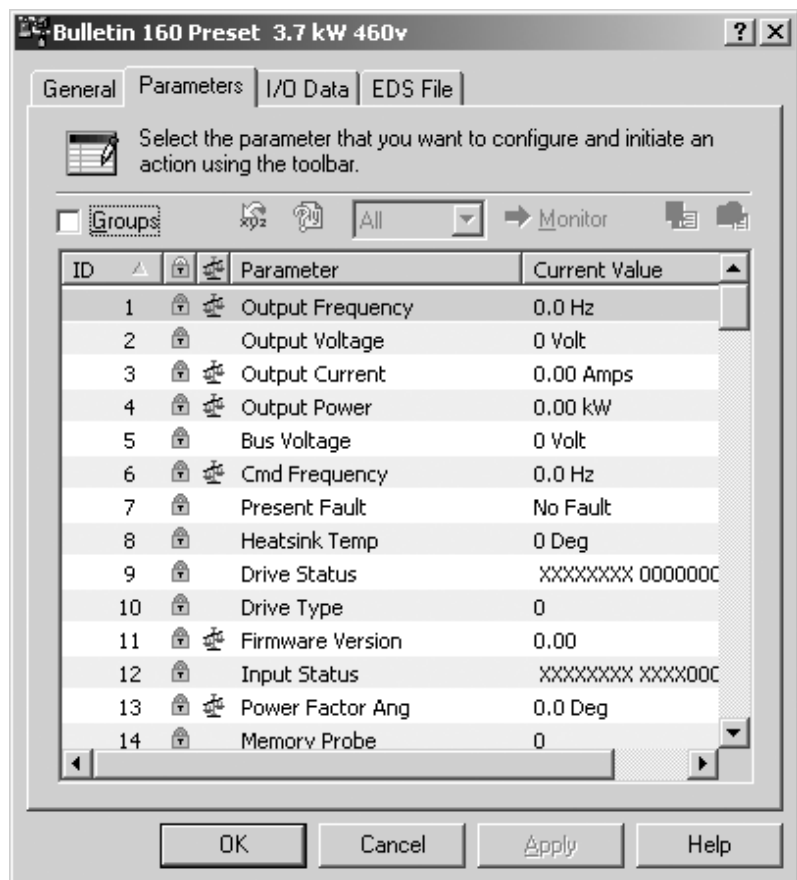

Selecting Input and Output Assemblies for I/O Messaging

The DeviceNet Specification defines Assembly Objects as objects that “bind attributes of multiple objects to allow data to or from each object to be sent over a single connection.” The 160-DN2 module uses Assembly Objects to send data to and from a Scanner over an I/O connection. The terms *input* and *output* are defined from the scanner’s point of view. Therefore, Output Assemblies are information that is output from the scanner and consumed by the 160-DN2 module. Input Assemblies are the status information produced by the module and consumed as input by the scanner.

The 160-DN2 module lets you select between various Input and Output Assemblies, thereby choosing the data format of the messages that are passed back and forth between the module and the scanner on the I/O connection. The Assemblies that are supported are numbered and are part of a DeviceNet-defined “Motor Control Hierarchy.” This lets drives directly replace motor starters or contactors on a network without the need to reprogram the scanner. Refer to *Appendix B*, pages [B-23](#) to [B-28](#) for information on the data format of all Bulletin 160 Assemblies.

DeviceNet parameters **P107 - [Output Assembly]** and **P108 - [Input Assembly]** must be programmed with the proper output or input assembly. Refer to *Chapter 5*, [Page 5-4](#) for available selections.

Use the information that is appropriate to your particular system to determine which Input and Output Assembly to use. See [Appendix B](#) for descriptions of all Input and Output Assemblies.

To illustrate how to select the Assemblies, we will use Output Assembly 103 and Input Assembly 104 as examples. The data formats for these Assemblies are:

Table 6.A Output Assembly 103 Data Format

Byte	Bit 7	Bit 6	Bit 5	Bit 4	Bit 3	Bit 2	Bit 1	Bit 0
0	N/A	N/A	Direction	Direction	Clear Faults	N/A	Start	Stop
1	N/A	Reference Select	Reference Select	Reference Select	N/A	N/A	N/A	N/A
2	Scale Speed Reference (Low Byte)							
3	Scale Speed Reference (High Byte)							

Table 6.B Input Assembly 104 Data Format

Byte	Bit 7	Bit 6	Bit 5	Bit 4	Bit 3	Bit 2	Bit 1	Bit 0
0	Fault	N/A	Decel	Accel	Rot Dir	Cmd Dir	Running	Enabled
1	Freq Source	Freq Source	Freq Source	Freq Source	Local	Local	Local	At Speed
2	Actual Speed Reference 0-32767							
3	Actual Speed Reference 0-32767							

Selecting Input and Output Assemblies for I/O Messaging (Continued)

An example screen ([Figure 6.4](#)) shows Output Assembly 103 and Input Assembly 104 selected. The following steps were used:

Changing the Output Assembly

1. In the Current Value column, double-click on the value for **Parameter 107 - [Output Assembly]**.
2. Enter Assembly Number “103.”
3. Click **Apply** to save the changes.

Changing the Input Assembly

1. In the Current Value column, double-click on the value for **Parameter 108 - [Input Assembly]**.
2. Enter Assembly Number “104.”
3. Click **Apply** to save the changes.

Figure 6.4
Example Input and Output Assemblies Screen

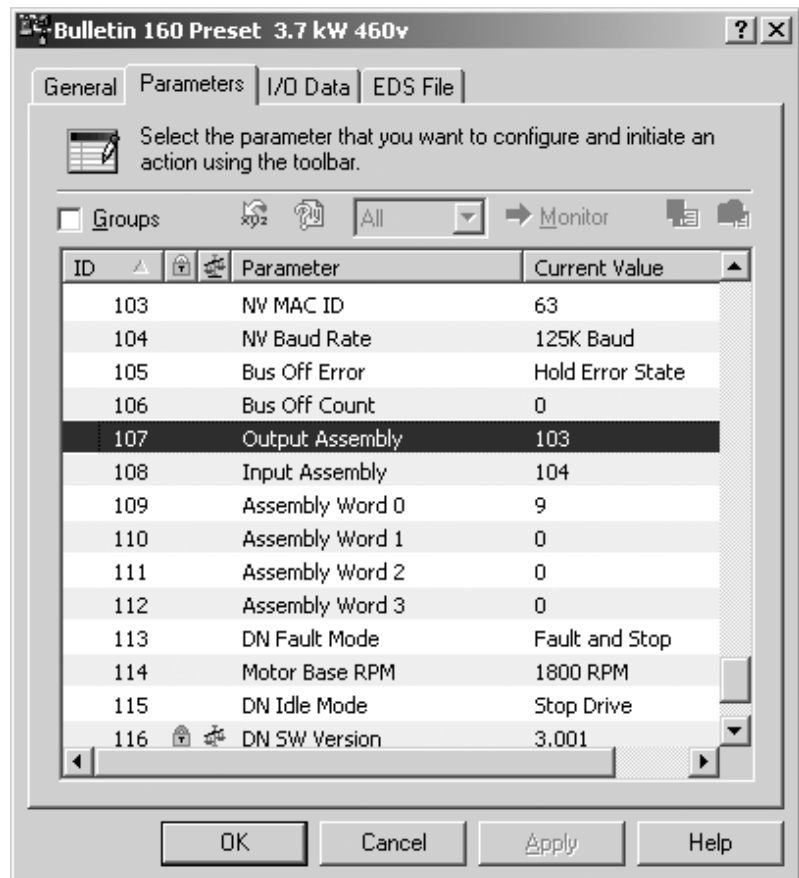

Enabling Network Control

The 160-DN2 module must be configured to accept commands from the network. To do this, configure the drive “Input Mode” parameter (Figure 6.5).

Configuring Drive Input Mode

1. In the Current Value column, click on the value for **Parameter 46 - [Input Mode]** and select “Network Control” from the dropdown list.

Important: Remember to jumper or close drive Terminals 7 and 8 on TB2 before the drive can start.

2. Click **Apply** to save the changes.



ATTENTION: Changing this parameter value may cause unpredictable network conditions, resulting in equipment damage, personal injury, or death. Ensure that you understand how changing this parameter affects your application.

Figure 6.5
Network Control Screen

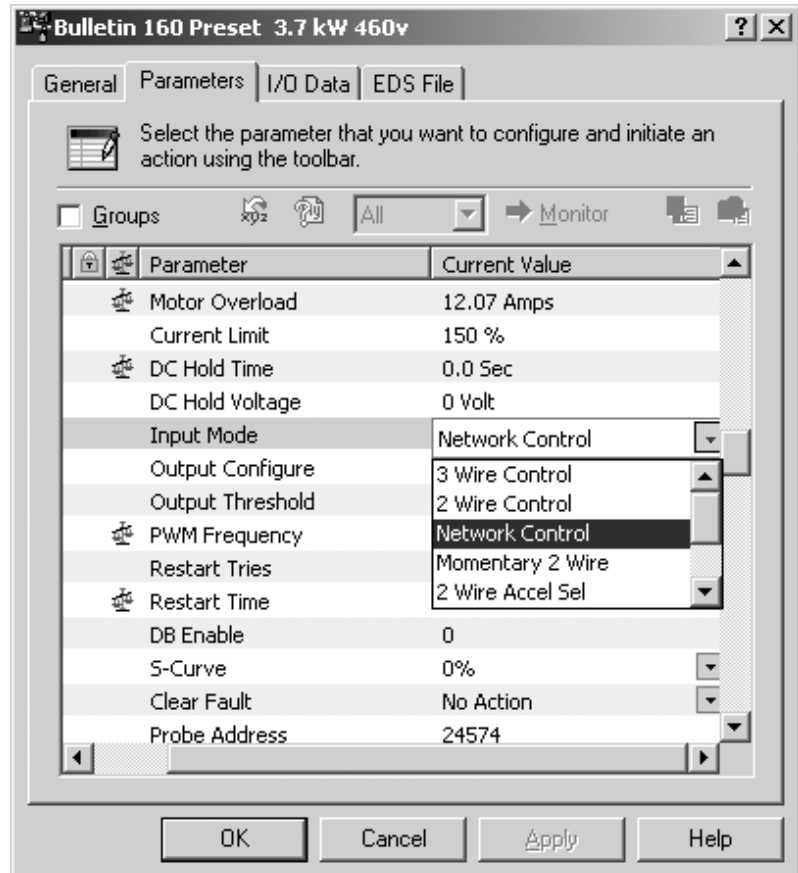

Enabling Network Control (Continued)

For the new input mode to take effect, modify the drive “Reset Functions” parameter ([Figure 6.6](#)).

Modifying Drive Reset Functions

1. In the Current Value column, click on the value for **P56 - [Reset Functions]** and select “Reset Input Mode” from the dropdown list.
2. Click **Apply** to save the changes.

Figure 6.6
Reset Input Mode Screen

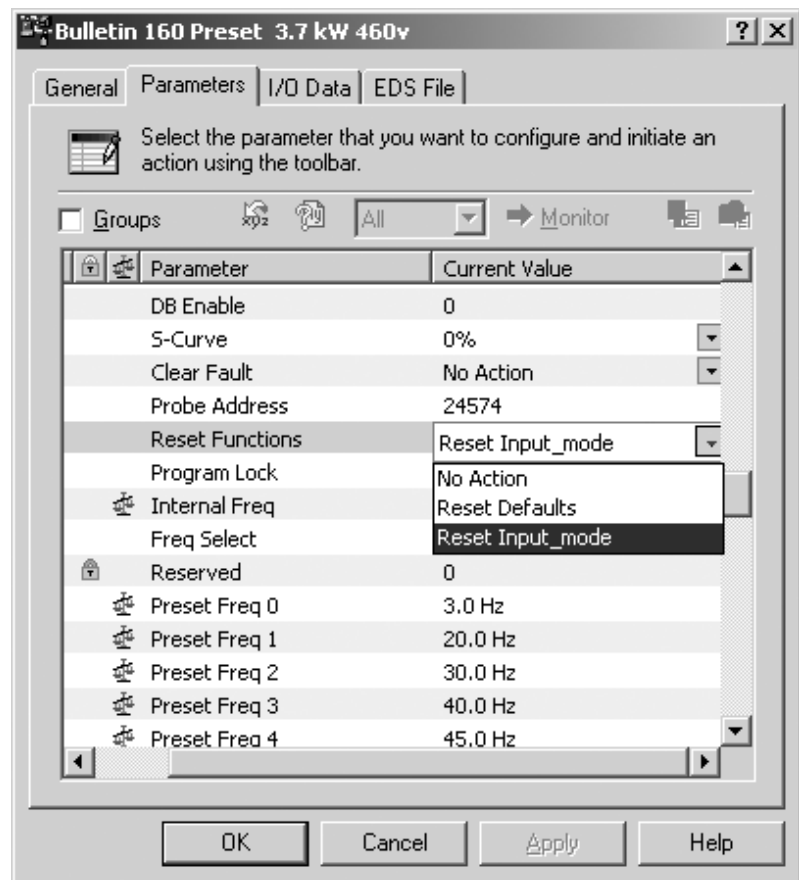

Configuring the 160 to Accept Speed Commands from the Network

The 160-DN2 module must be configured to accept its speed commands from the network. To do this, change the drive “Frequency Select” parameter ([Figure 6.7](#)).

1. In the Current Value column, click on the value for **P59 - [Frequency Select]** and select “Internal Freq” from the dropdown list.
2. Click **Apply** to save the changes.
3. Click **OK** to close the window.

Figure 6.7
Frequency Select Screen

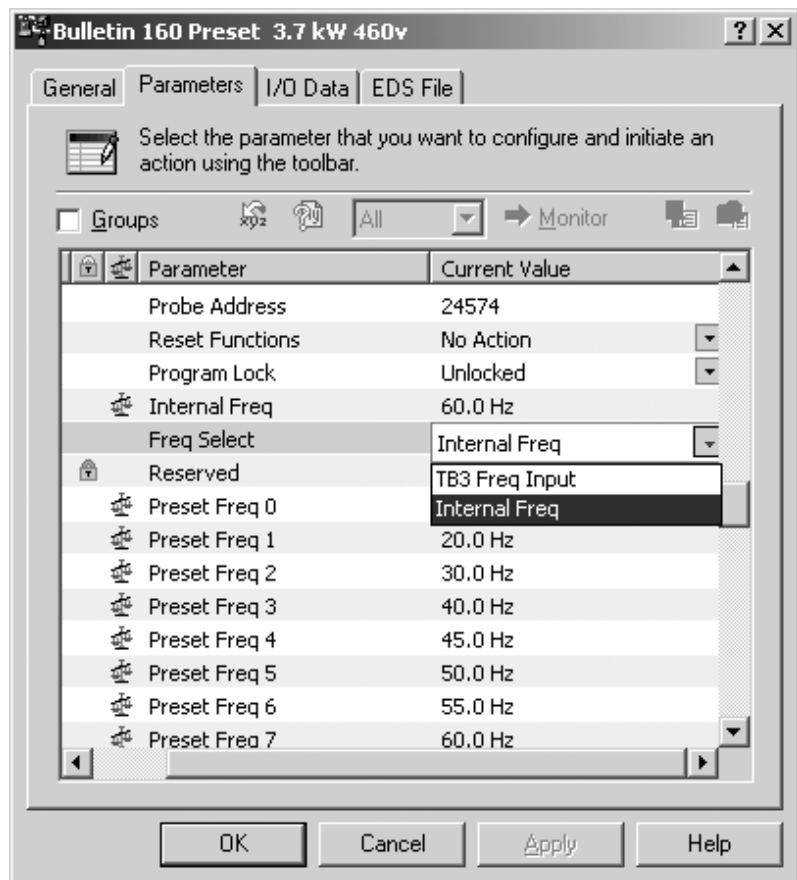

Configuring the Scanner

The scanner must be configured to communicate with the 160-DN2 module and connected Bulletin 160-SSC drive.

Example Network

After the module is configured, the connected drive and module become a single node on the network. This section provides a step-by-step procedure to configure the scanner in a network, such as the simple network example shown in [Figure 6.8](#). In our example, we will configure the drive for using the example Output Assembly 103 and Input Assembly 104.

Figure 6.8
Example DeviceNet Network

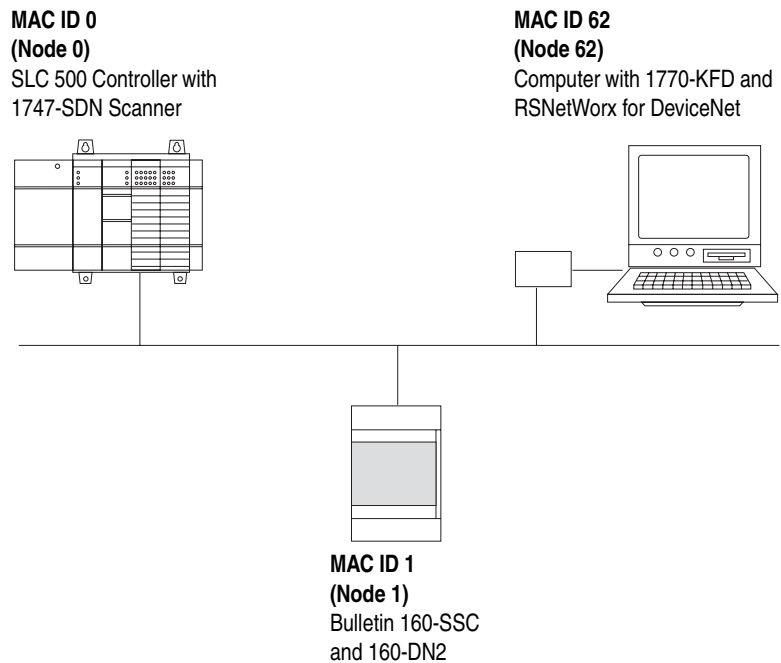

Configuring the Scanner (Continued)

Setting Up the Scan List

For the scanner to communicate with a drive, the scanner must be configured and the drive's node number must be added to its scan list.

1. Go online with RSNetWorx for DeviceNet. The devices on the network are displayed in the configuration view.

Figure 6.9
Configuration View (Graph)

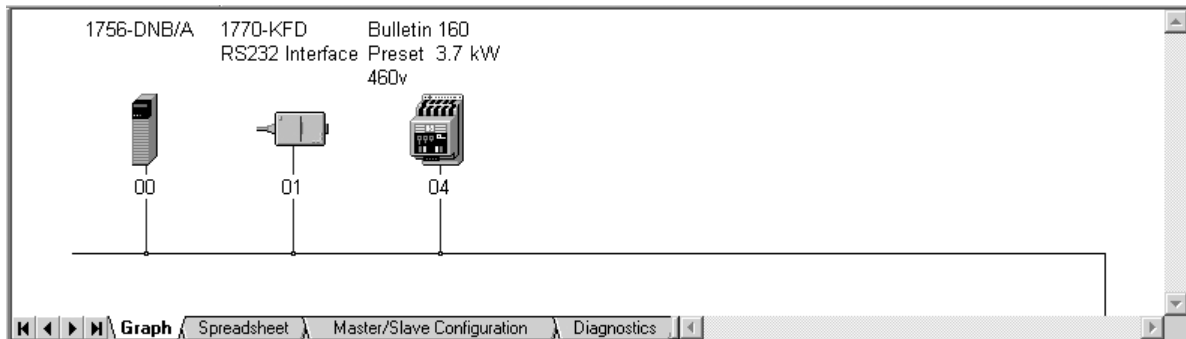

2. Right-click the DeviceNet scanner (MAC ID 00 in [Figure 6.9](#)) and select **Properties**. The Scanner Module dialog box appears.

Important: If your scanner is an unrecognized device, you must create an EDS file for it and then configure the scanner. Create an EDS file by following the instructions using the EDS Wizard (see [Page 6-3](#) for details). Configure the scanner using the General and Module tabs. If you need more information, click **Help** or refer to your scanner documentation.

3. Click the **Scanlist** tab. A message box prompts you to upload.
4. Click **Upload**. Data is uploaded from the scanner, and then the Scanlist page ([Figure 6.10](#)) appears.
5. Click the **Automap on Add** box (a check mark will appear).
6. In the “Available Devices” list, select the drive, and then click > (Right Arrow) to move it to the “Scanlist.”

Configuring the Scanner (Continued)

Figure 6.10
Scanlist Page in the Scanner Module Dialog Box

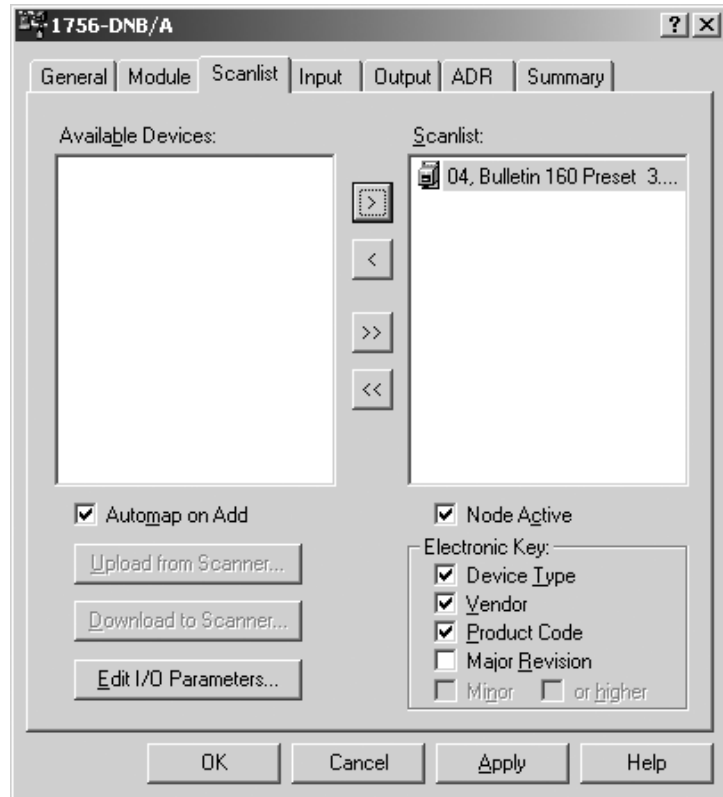

7. In the “Scanlist,” select the drive, and then click **Edit I/O Parameters**. The Edit I/O Parameters dialog box ([Figure 6.11](#)) appears.

Figure 6.11
Edit I/O Parameters Dialog Box

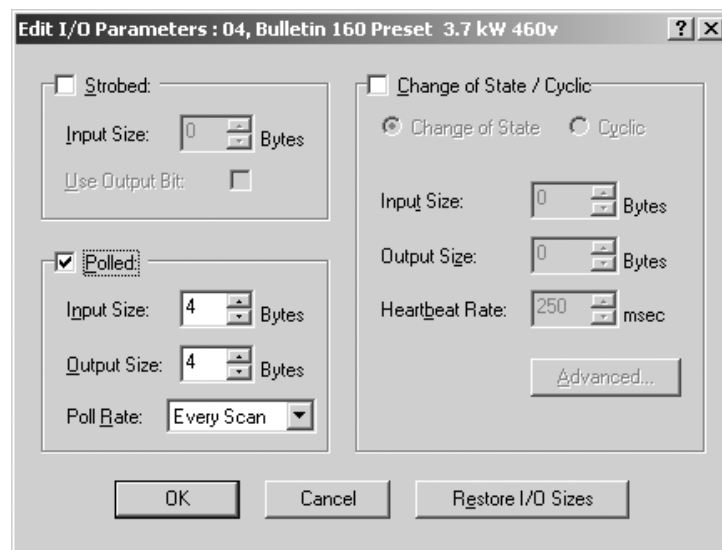

8. Select the type(s) of data exchange (Strobed, Polled, Change of State or Cyclic). In our example, we selected Polled.

Configuring the Scanner (Continued)

9. Type the number of bytes that are required for your I/O in the Input Size and Output Size boxes.

Refer to *Appendix B*, pages [B-23](#) to [B-28](#) for all Bulletin 160 Assemblies.

In our example, we typed “4” in the Input Size and Output Size boxes because we are using Output Assembly 21 and Input Assembly 71.

10. Set the required rate for the data exchange selected in step 8. (Click **Help** for more information.)

Data Exchange	Rate to Set
Strobed	N/A
Polled	Poll Rate
Change of State	Heartbeat Rate
Cyclic	Send Rate

In our example using Polled data exchange, we selected “Every Scan” for the Poll Rate.

11. Click **OK**. If you changed any settings, a Scanner Applet asks if it is OK to unmap the I/O. Click **Yes** to continue. The Edit I/O Parameters dialog box closes and then the Scanner Module dialog box ([Figure 6.10](#)) reappears. You will map the I/O in the next section in this chapter.

Mapping the Drive Data in the Scanner

Data from I/O messages must be mapped in the scanner. This mapping determines where a ladder logic program can find data that is passed over the network. You must map both the Input I/O and the Output I/O.

Mapping the Input I/O

1. In the Scanner Module dialog box, click the **Input** tab. (If necessary, right-click the scanner in the configuration view ([Figure 6.9](#)) to display this dialog box.)

Configuring the Scanner (Continued)

Figure 6.12
Input Page on the Scanner Module Dialog Box

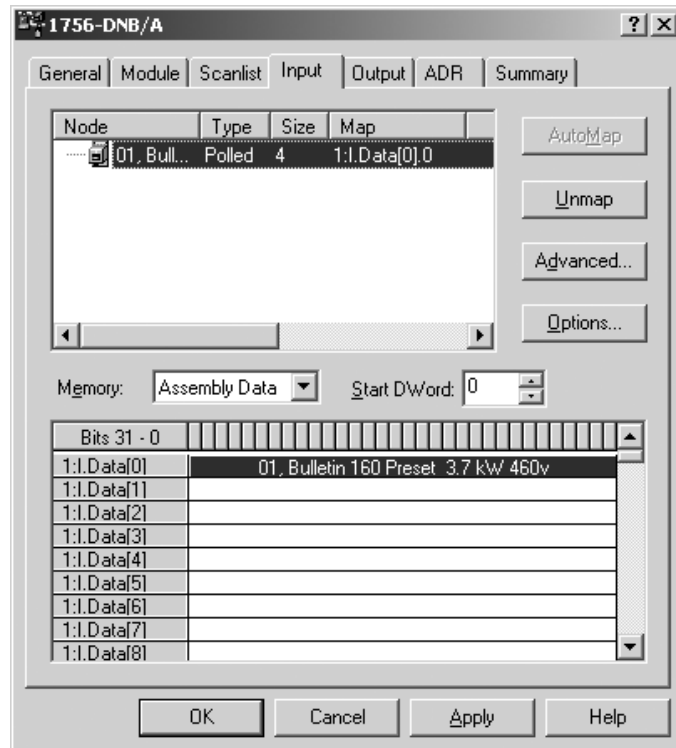

If you selected the **Automap on Add** box in the Scanlist tab (Figure 6.10), RSNetWorx has already mapped the I/O. If it is not mapped, click **Automap** to map it. If you need to change the mapping, click **Advanced** and change the settings. Click **Help** for assistance.

2. In the Memory box, select a location in scanner memory.

Scanner	Memory Locations
1747-SDN	Discrete or M-File
1756-DNB	Assembly Data
1771-SDN	Block Xfer 62 – 57

In our example, we are using a 1756-DNB scanner and selected Assembly Data.

3. In the Start DWord box, select the word in memory at which the data should start. In our example, we selected 0. Due to the 32-bit data used by the 1756-DNB scanner in our example, the Logic Status and Speed Feedback information are combined in address 1:I.Data[0], where 1 equals the slot number of the scanner. Therefore, the Logic Status is defined by bits 0-15 (least significant word), and the Speed Feedback is defined by bits 16-31 (most significant word).

Configuring the Scanner (Continued)

Mapping the Output I/O

1. In the Scanner Module dialog box, click the **Output** tab. To display this dialog box, right-click the scanner in the configuration view ([Figure 6.9](#)).

Figure 6.13
Output Page on the Scanner Module Dialog Box

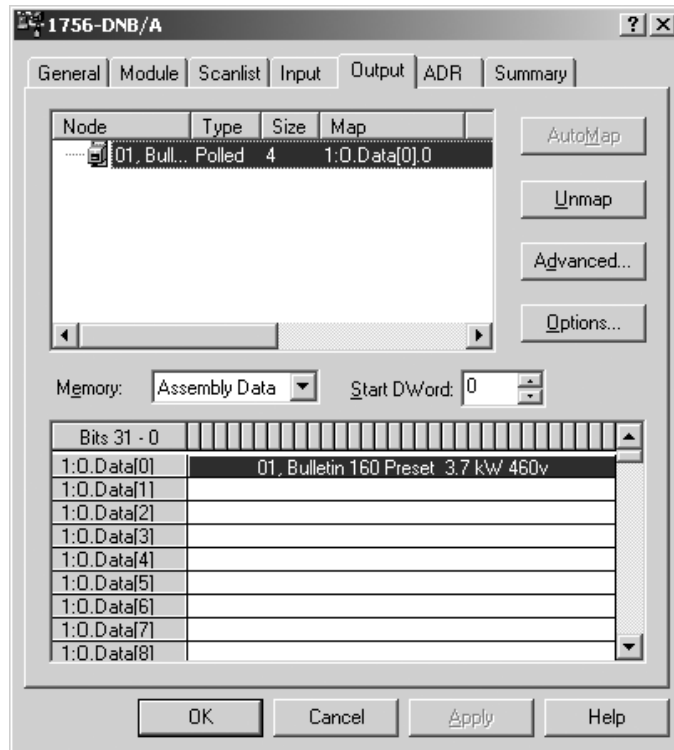

If you selected the **Automap on Add** box in the Scanlist tab ([Figure 6.10](#)), RSNetWorx has already mapped the I/O. If it is not mapped, click **Automap** to map it. If you need to change the mapping, click **Advanced** and change the settings. Click **Help** for assistance.

2. In the Memory box, select a location in scanner memory.

Scanner	Memory Locations
1747-SDN	Discrete or M-File
1756-DNB	Assembly Data
1771-SDN	Block Xfer 62 – 57

In our example, we are using a 1756-DNB scanner and selected Assembly Data.

Configuring the Scanner (Continued)

3. In the Start DWord box, select the word in memory at which the data should start. In our example, we selected 0. Due to the 32-bit data used by the 1756-DNB scanner in our example, the Logic Command and Speed Reference information are combined in address 1:O.Data[0], where 1 equals the slot number of the scanner. Therefore, the Logic Command is defined by bits 0-15 (least significant word), and the Speed Reference is defined by bits 16-31 (most significant word).

Saving the Configuration

After configuring a scanner, you must download it to the scanner. You should also save it to a file on your computer.

1. In the Scanner Module dialog box ([Figure 6.13](#)), click **Apply** to save the configuration to the scanner. A Scanner Configuration Applet appears and asks if it is OK to download the changes.
2. Click **Yes** to download the changes. The changes are downloaded and then the Scanner Module dialog box reappears.
3. Click **OK** to close the Scanner Module dialog box.
4. Select **File > Save**. If this is the first time that you saved the project, the Save As dialog box appears. Navigate to a folder, type a file name, and click **Save** to save the scanner configuration to a file.

Using I/O Messaging

This section discusses how to use I/O messaging after you have configured the 160-DN2 module and scanner.

Example Ladder Logic Programs

These example ladder logic programs ([Figure 6.14](#), [Figure 6.15](#), and [Figure 6.16](#)) work with the Bulletin 160 SSC drive.

Functions of the Example Programs

The example programs use an operator station wired to an I/O module in Slot 0, Module Group 0, Rack 0. The operator can perform these actions:

- Obtain status information from the drive.
- Use the Logic Command to control the drive (for example, start, stop).
- Send a Reference to the drive.

Using I/O Messaging (Continued)

ControlLogix Example

Table 6.C Tags for the Example Program

Tag Name	Type	Tag Name	Type
Local:1:I	DINT[]	DriveFeedback	INT
Local:1:O	DINT[]	DriveInputImage	INT[2]
DriveCommandClearFault	BOOL	DriveOutputImage	INT[2]
DriveCommandJog	BOOL	DriveReference	INT
DriveCommandStart	BOOL	DriveStatusFaulted	BOOL
DriveCommandStop	BOOL	DriveStatusRunning	BOOL

Figure 6.14
Example ControlLogix Ladder Logic Program

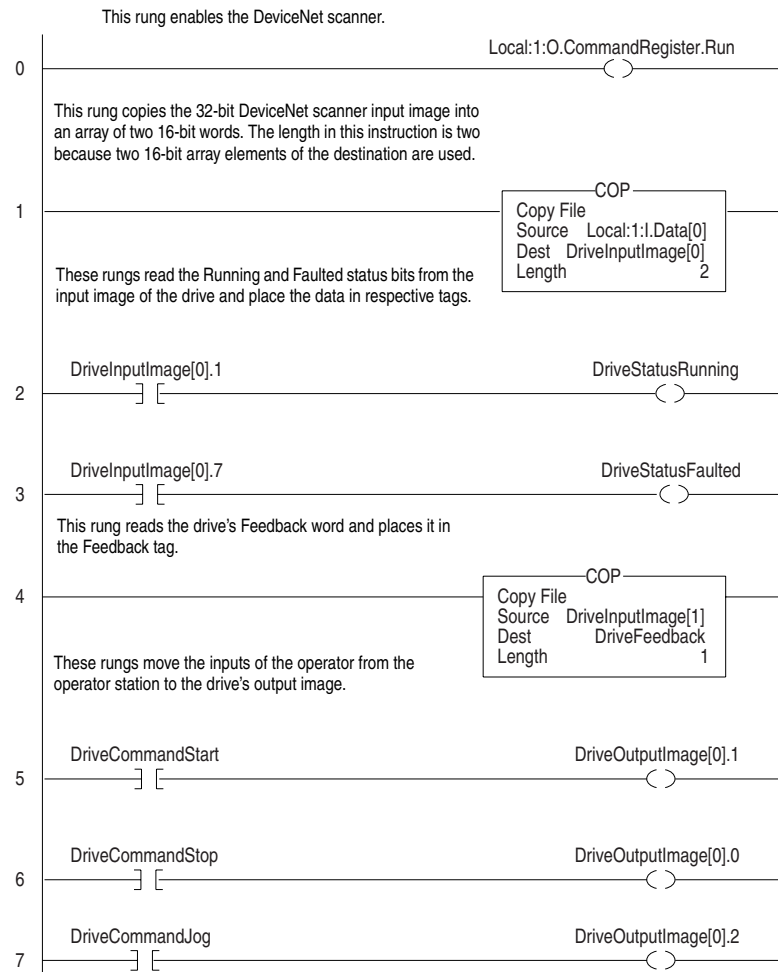

Using I/O Messaging (Continued)

Figure 6.14
Example ControlLogix Ladder Logic Program (Continued)

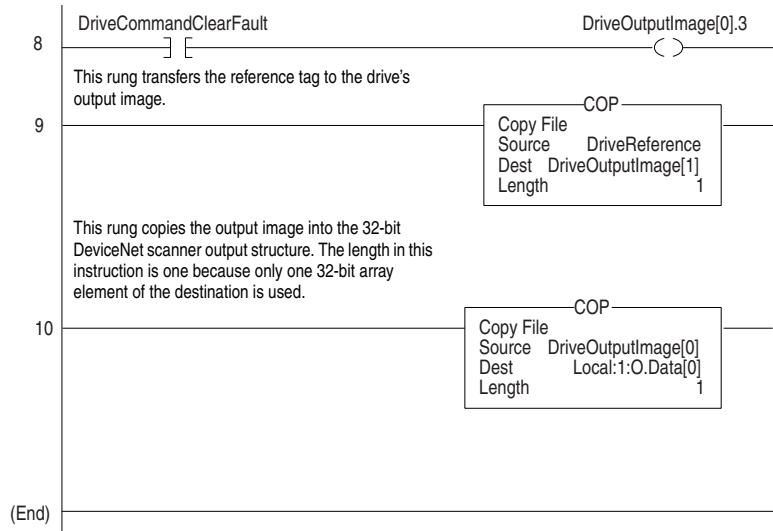

Using I/O Messaging (Continued) PLC-5 Example

Table 6.D Control File for Block Transfer

	EN	ST	DN	ER	CO	EW	NR	TO	RW	RLEN	DLEN	FILE	ELEM	R	G	S
BT20:0	0	0	0	0	0	0	0	0	0	62	0	9	0	00	0	0
BT20:1	0	0	0	0	0	0	0	0	0	62	0	10	0	00	0	0

Figure 6.15 Example PLC-5 Ladder Logic Program

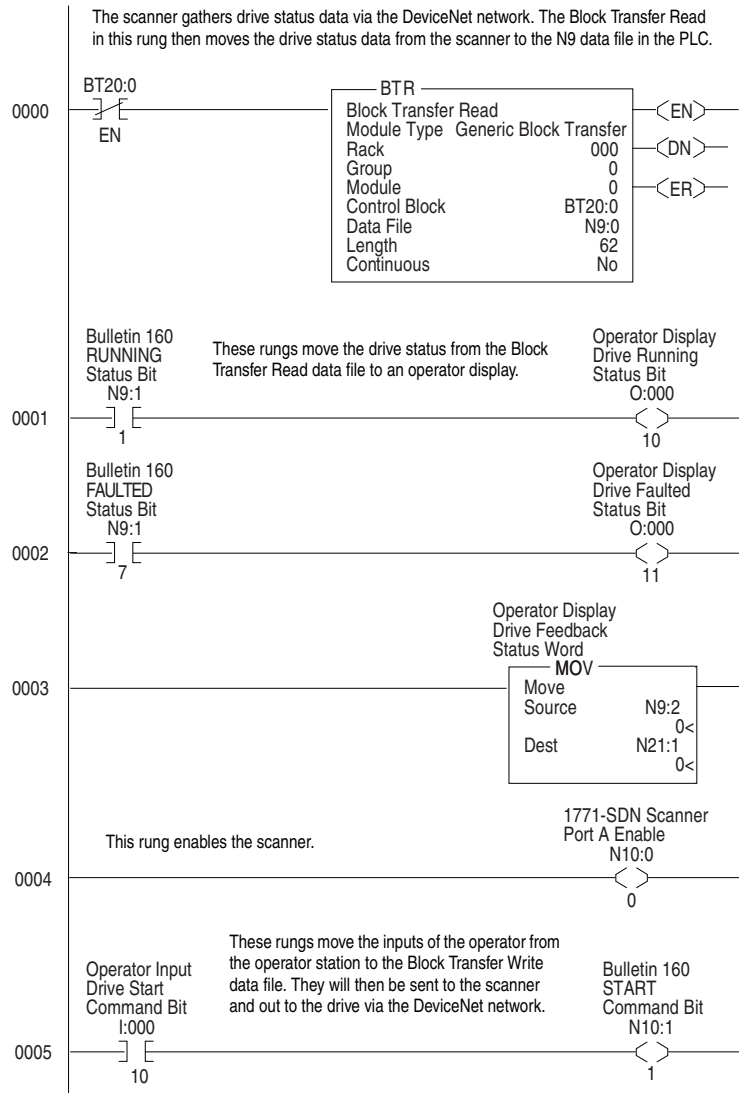

Using I/O Messaging (Continued)

Figure 6.15
Example PLC-5 Ladder Logic Program (Continued)

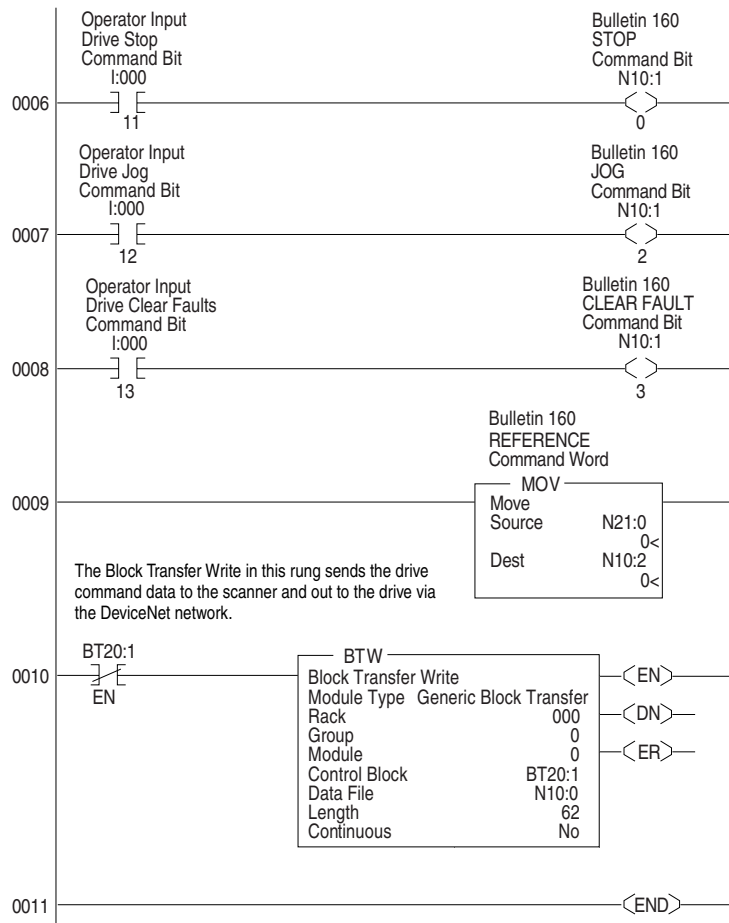

Using I/O Messaging (Continued)

SLC Example

Figure 6.16
Example SLC Ladder Logic Program

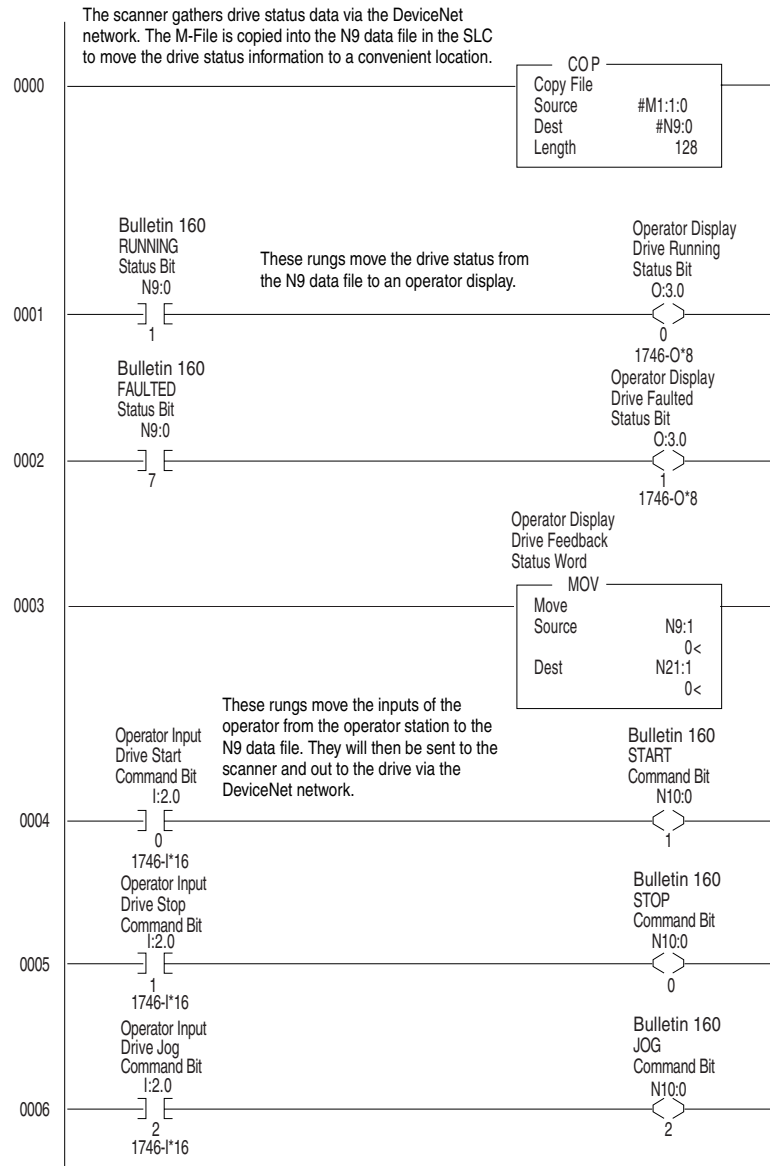

Using I/O Messaging (Continued)

Figure 6.16
Example SLC Ladder Logic Program (Continued)

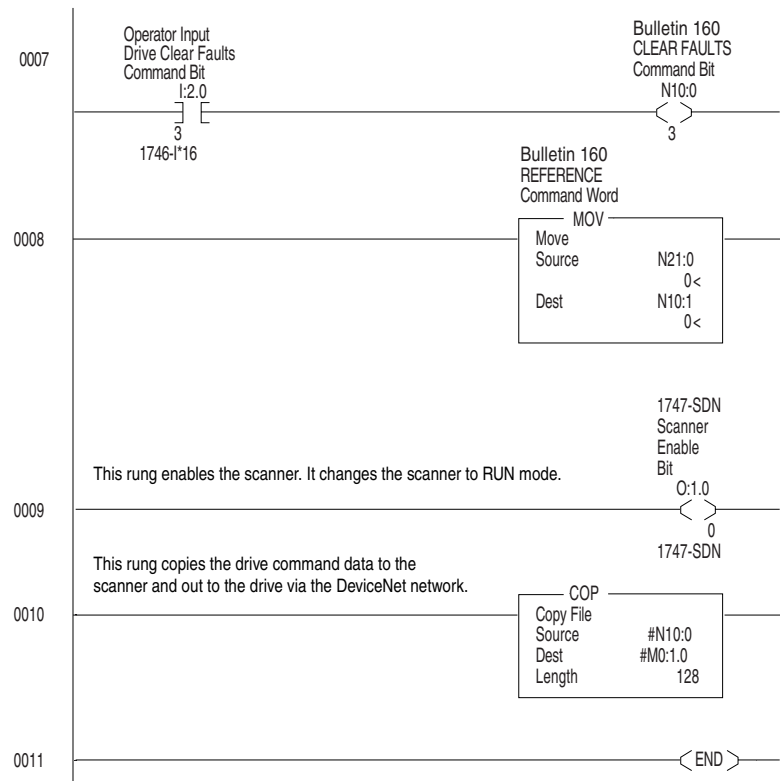

Using Explicit Messaging

This section provides information and examples that explain how to use Explicit Messaging to monitor and configure the 160-DN2 module and connected Bulletin 160-SSC drive.



ATTENTION: Hazard of injury or equipment damage exists. The examples in this publication are intended solely for purposes of example. There are many variables and requirements with any application. Rockwell Automation does not assume responsibility or liability (to include intellectual property liability) for actual use of the examples shown in this publication.



ATTENTION: Hazard of equipment damage exists. If Explicit Messages are programmed to write parameter data to Non-Volatile Storage (NVS) frequently, the NVS will quickly exceed its life cycle and cause the drive to malfunction. Do not create a program that frequently uses Explicit Messages to write parameter data to NVS.

About Explicit Messaging

Explicit Messaging is used to transfer data that does not require continuous updates. With Explicit Messaging, you can configure and monitor a slave device's parameters on the DeviceNet network.

Formatting Explicit Messages

Explicit Messages for a ControlLogix Controller

ControlLogix scanners accommodate both downloading Explicit Message Requests and uploading Explicit Message Responses. The scanner module can accommodate one request or response for each transaction block. Each transaction block must be formatted as shown in [Figure 6.17](#). For explicit message class codes and attribute information, refer to [Appendix B](#).

Using Explicit Messaging (Continued)

Figure 6.17
ControlLogix Message Format in RSLogix 5000

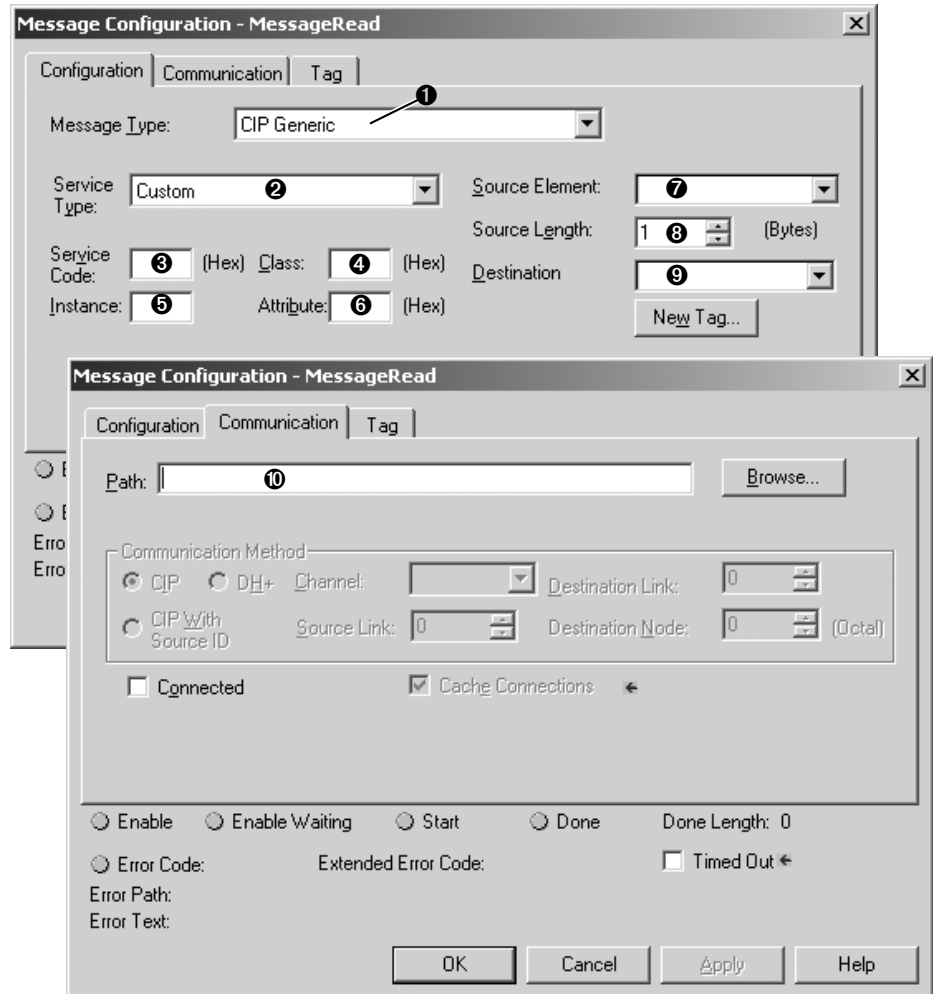

See [Page 6-25](#) for a description of the data required for each box (1 – 7).

- ▶ **TIP:** To display the Message Configuration dialog box in RSLogix 5000, add a message instruction, create a tag for the message (properties: base tag, MESSAGE data type, controller scope), and click the blue box inside the message.

Using Explicit Messaging (Continued)

The following table identifies the number of Explicit Messages that can be executed at a time.

Scanner	Messages at One Time	Refer To
1756-DNB	5	Figure 6.17

ControlLogix Message Requests and Responses

Box	Description
❶	Message Type The message type must be CIP Generic.
❷	Service Type This box contains the type of function that the message will perform. The default function is Custom.
❸	Service Code The service code is the requested DeviceNet service, entered as a hex value. Available services depend on the class and instance that you are using. Refer to Appendix B .
❹	Class The object class is a DeviceNet class, entered as a hex value. Refer to Appendix B for available classes.
❺	Instance The object instance is determined by the selected DeviceNet class. Refer to Appendix B for available instances.
❻	Attribute The object attribute is a class or instance attribute, entered as a hex value. Refer to Appendix B for available classes.
❼	Source Element This box contains the name of the tag for any service data to be sent from the scanner to the module and drive.
❽	Source Length This box contains the length (in bytes) of the tag used for the Source Element.
❾	Destination This box contains the name of the tag that will receive service response data from the module and drive.
❿	Path The path includes the following: <ul style="list-style-type: none"> • Name of the DeviceNet scanner. • Communication port on the front of the 1756-DNB scanner. Always 2. • Node address of the 160-DN2 module. This is set with switches or parameters in the module. Tip: Click Browse to find the path or type in the name of a module that you previously mapped. For proper set up, refer to ControlLogix online Help.

Using Explicit Messaging (Continued)

Explicit Messages for a PLC-5 or SLC Controller

Transaction blocks in PLC-5 and SLC scanners accommodate both downloading Explicit Message Requests and uploading Explicit Message Responses. The scanner module can accommodate one request or response for each transaction block. Each transaction block must be formatted as shown in [Figure 6.18](#) or [Figure 6.19](#).

Figure 6.18
PLC-5 Explicit Message Format

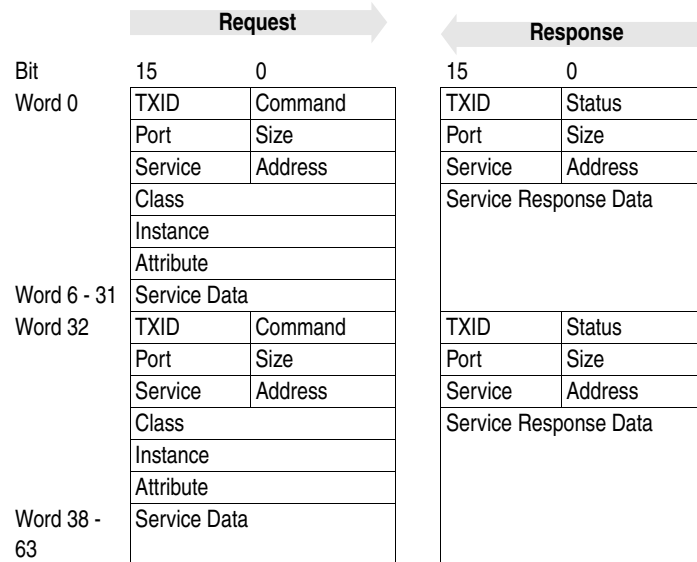
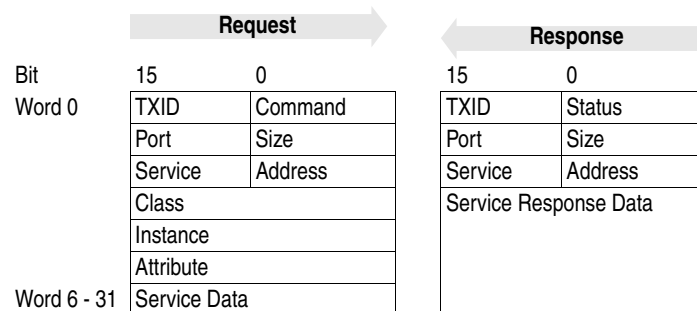

Figure 6.19
SLC Explicit Message Format



Refer to [Page 6-27](#) and [Page 6-28](#) for a description of the data that is required in each word.

The following table identifies the number of transaction blocks within a scanner that are reserved for Explicit Messaging.

Scanner	Number of Transaction Blocks	Words in Each Transaction Block	Refer to ...
1771-SDN	10	32 (two blocks can be moved at once)	Figure 6.18
1747-SDN	10	32	Figure 6.19

Using Explicit Messaging (Continued)

PLC-5 / SLC Explicit Message Requests

Word	Description
0	<p>Command (Least Significant Byte)</p> <p>The Command is a code that instructs the scanner how to administer the request during each download.</p> <p>00 = Ignore transaction block (empty)</p> <p>01 = Execute this transaction block</p> <p>02 = Get status of transaction TXID</p> <p>03 = Reset all client/server transactions</p> <p>04 = Delete this transaction block (available only for SLC)</p> <p>05 – 255 = Reserved</p> <p>TXID (Most Significant Byte)</p> <p>The Transaction ID is a 1-byte integer between 1 and 255. It is assigned in the ladder logic program when the processor creates and downloads a request to the scanner. The scanner uses it to track the transaction to completion. It returns this value with the response that matches the request downloaded by the processor.</p>
1	<p>Size (Least Significant Byte)</p> <p>The size of the service data is in bytes. Service data includes the words for the class, instance, attribute, and any data. The maximum size is 58 bytes (29 words).</p> <p>Port (Most Significant Byte)</p> <p>The port that is used by the message is always zero (Channel A) on an SLC scanner. It is zero (Channel A) or one (Channel B) for a PLC scanner.</p>
2	<p>Address (Least Significant Byte)</p> <p>The node address of the slave device to which the transaction is sent. For the Explicit Message to be successful, the slave device must be in the scanlist of the scanner, and it must be online.</p> <p>Service (Most Significant Byte)</p> <p>Available services depend on the class and instance that you are using. Refer to Appendix B for available service.</p>
3	<p>Class</p> <p>Refer to Appendix B for available classes.</p>
4	<p>Instance</p> <p>Refer to Appendix B for available instances.</p>
5	<p>Attribute</p> <p>Refer to Appendix B for available attributes.</p>
6 – 31	<p>Request Data</p> <p>This is data used for the message. For example, it may be the value written to a parameter.</p>

Using Explicit Messaging (Continued)

PLC-5 / SLC Explicit Message Responses

Word	Description
0	<p>Status (Least Significant Byte)</p> <p>One of the following status codes is provided during each upload:</p> <p>00 = Ignore transaction block (empty)</p> <p>01 = Transaction completed successfully</p> <p>02 = Transaction in progress (not ready)</p> <p>03 = Slave not in scan list</p> <p>04 = Slave offline</p> <p>05 = DeviceNet port disabled or offline</p> <p>06 = Transaction TXID unknown</p> <p>08 = Invalid command code</p> <p>09 = Scanner out of buffers</p> <p>10 = Other client/server transaction in progress</p> <p>11 = Could not connect to slave device</p> <p>12 = Response data too large for block</p> <p>13 = Invalid port</p> <p>14 = Invalid size specified</p> <p>15 = Connection busy</p> <p>16 – 255 = Reserved</p> <p>TXID (Most Significant Byte)</p> <p>The transaction ID is a 1-byte integer in word 31 with a range of 1 to 255. It is assigned in the ladder logic program when the processor creates and downloads a request to the scanner. The scanner uses it to track the transaction to completion. It returns this value with the response that matches the request downloaded by the processor.</p>
1	<p>Size (Least Significant Byte)</p> <p>The size of the service data is in bytes. The service data includes words used for the response data. The maximum size is 58 bytes (29 words).</p> <p>Port (Most Significant Byte)</p> <p>The port that is used by the message is always zero (Channel A) on an SLC scanner. It is zero (Channel A) or one (Channel B) for a PLC scanner.</p>
2	<p>Address (Least Significant Byte)</p> <p>The node address of the slave device to which the transaction is sent. For the Explicit Message to be successful, the slave device must be in the scanlist of the scanner, and it must be online.</p> <p>Service (Most Significant Byte)</p> <p>If the message was successful, 0x80 is added to the service. If it is unsuccessful, 0x94 is returned.</p>
3 – 31	<p>Response Data</p> <p>This is data used for the message. For example, it may be the value read from a parameter.</p>

Refer to [Page 6-27](#) for a description of the words in a PLC/SLC Explicit Message request.

Using Explicit Messaging (Continued)

Executing Explicit Messages

There are five basic events in the Explicit Messaging process. The details of each step will vary depending on the controller (ControlLogix, PLC-5, or SLC). Refer to the documentation for your controller.

Important: There must be a request message and an response message for all Explicit Messages, whether you are reading or writing data.

Figure 6.20
Explicit Message Process

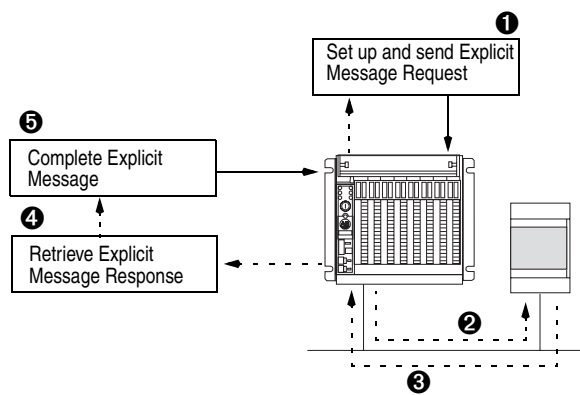

Event

1. You format the required data and set up the ladder logic program to send an Explicit Message request to the scanner module (download).
2. The scanner module transmits the Explicit Message Request to the slave device over the DeviceNet network.
3. The slave device transmits the Explicit Message Response back to the scanner. The data is stored in the scanner buffer.
4. The controller retrieves the Explicit Message Response from the scanner's buffer (upload).
5. The Explicit Message is complete. If you are using a PLC-5 or SLC, delete the transaction ID so that it can be reused.

Using Explicit Messaging (Continued)

ControlLogix Example

Data Format for a Read and Write Parameter

The data in this example is for a Bulletin 160-SSC drive at MAC ID 1.

For a description of the content in each box, refer to the “[Formatting Explicit Messages](#)” subsection starting on [Page 6-23](#).

Figure 6.21
ParameterReadMessage Screen

Box	Setting	Description	Refer to . . .
Message Type	CIP Generic	Must be CIP Generic	6-25
Service Type	Get Attribute Single	Defines Service Code as text message	6-25
Class	B3 (hex)	160 Parameter Table Object	B-18
Instance	1 (dec)	Number of Instances	B-18
Attribute	3 (hex)	Parameter Number ①	B-18
Destination	②	User-created tag for parameter data	6-25

① For this example screen, Parameter 3 - [Output Current] was selected.

② For this example screen, the tag Output_Current was created and assigned. To create a tag, click **New Tag**, enter tag name, select Data Type, and click **OK**. To assign this tag, click on the Destination dropdown arrow, select the defined tag, and click outside the dropdown list.

Using Explicit Messaging (Continued)

Figure 6.22
ParameterWriteMessage Screen

Box	Setting	Description	Refer to . . .
Message Type	CIP Generic	Must be CIP Generic	6-25
Service Type	Set Attribute Single	Defines Service Code as text message	6-25
Class	B3 (hex)	160 Parameter Table Object	B-18
Instance	1 (dec)	Number of Instances	B-18
Attribute	1E (hex)	Parameter Number ①	B-18
Source Element	②	User-created tag for parameter data	6-25
Source Length	2 (bytes)	Data Type	B-2

① For this example screen, Parameter 30 - [Accel Time 1] was selected.

② For this example screen, the tag Accel_Time_1 was created and assigned. To create a tag, click **New Tag**, enter tag name, select Data Type, and click **OK**. To assign this tag, click on the Source Element dropdown arrow, select the defined tag, and click outside the dropdown list.

Using Explicit Messaging (Continued)

**Table 6.E Tags for ControlLogix
Example Explicit Messaging Program**

Tag Names for Read Messages	Type	Tag Names for Write Messages	Type
StartParameterRead	BOOL	StartParameterWrite	BOOL
Output_Current	INT	ParameterWriteMessage	MESSAGE
ParameterReadMessage	MESSAGE	Accel_Time_1	INT

**Figure 6.23
ControlLogix Example Explicit Messaging Ladder Logic Program**

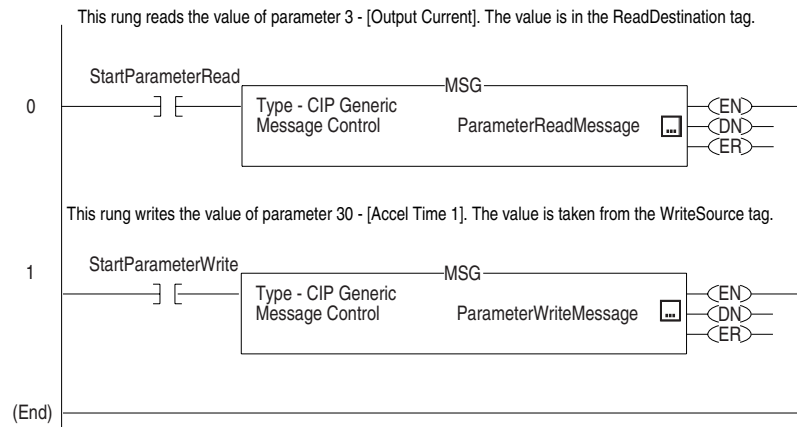

Using Explicit Messaging (Continued)

PLC-5 Example

Data Format for a Read and Write Parameter

The data in this example is for a Bulletin 160-SSC drive at MAC ID 1.

For a description of the content of the data file, refer to the “[Formatting Explicit Messages](#)” subsection starting on [Page 6-23](#).

Request Data for Read of Drive Parameter 3

Address	Value (hex)	Description	Refer to . . .
N30:0	0101	TXID = 01, Command = 01 (execute)	6-27
N30:1	0006	Port = 00, Size = 06 bytes	6-27
N30:2	0E01	Service = 0E (Get_Attribute_Single)	B-21
		Address = 01 (Drive Node Address)	6-27
N30:3	00B3	Class = B3 (160 Parameter Table Object)	6-27 , B-18
N30:4	0001	Instance = 1 (Number of Instances)	6-27 , B-18
N30:5	0003	Attribute = 03 (Parameter Number)	6-27 , B-18

Response Data for Read of Drive Parameter 3

Address	Value (hex)	Description	Refer to . . .
N30:70	0101	TXID = 01, Status = 01 (successful)	6-28
N30:71	0002	Port = 00, Size = 02 bytes	6-28
N30:72	8E01	Service = 8E (successful),	6-28
		Address = 01 (Drive Node Address)	
N30:73	0258	Response Data = 600 = 6.00 amperes	

Request Data for Write to Drive Parameter 30

Address	Value (hex)	Description	Refer to . . .
N30:0	0101	TXID = 01, Command = 01 (execute)	6-27
N30:1	0008	Port = 00, Size = 08 bytes	6-27
N30:2	1001	Service = 10 (Set_Attribute_Single)	B-21
		Address = 01 (Drive Node Address)	6-27
N30:3	00B3	Class = B3 (160 Parameter Table Object)	6-27 , B-18
N30:4	0001	Instance = 1 (Number of Instances)	6-27 , B-18
N30:5	001E	Attribute = 30 (Parameter Number)	6-27 , B-18
N30:6	07D0	Data = 2000 = 20.00 seconds	

Response Data for Write to Drive Parameter 30

Address	Value (hex)	Description	Refer to . . .
N30:70	0101	TXID = 01, Status = 01 (successful transaction)	6-28
N30:71	0000	Port = 00, Size = 00 bytes	6-28
N30:72	9001	Service = 90 (successful)	6-28
		Address = 01 (Drive Node Address)	

Using Explicit Messaging (Continued)

Figure 6.24
PLC-5 Example Explicit Messaging Ladder Logic Program

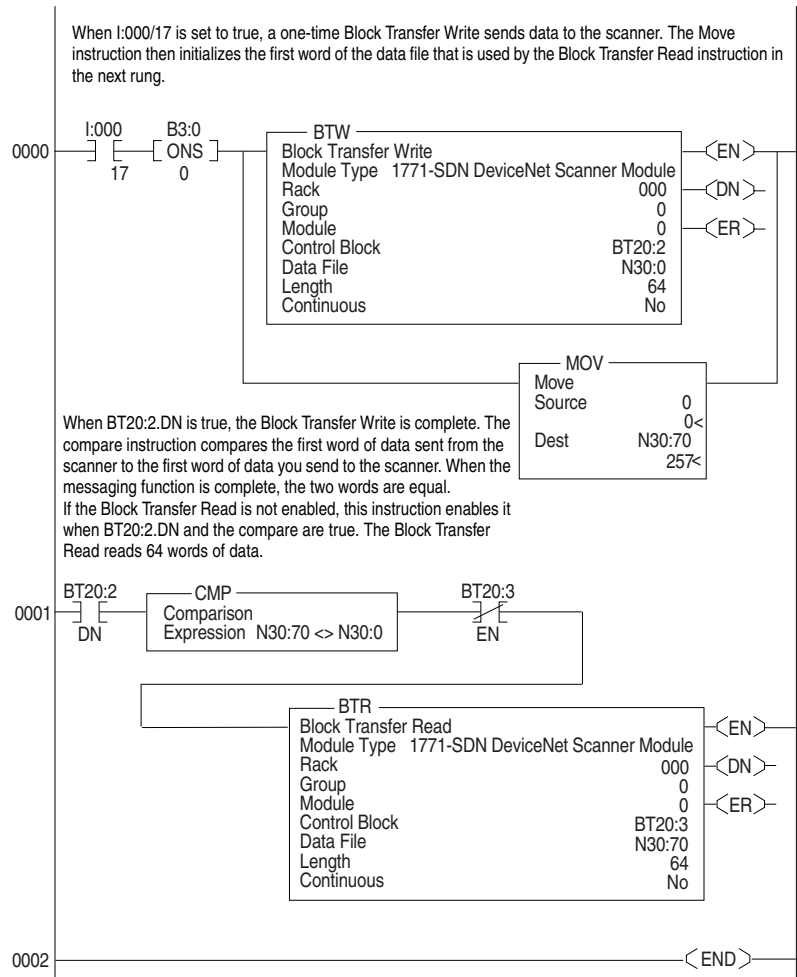

Using Explicit Messaging (Continued)

SLC Example

Data Format for a Read and Write Parameter

The data in this example is for a Bulletin 160-SSC drive at MAC ID 1.

For a description of the content of the data file, refer to the “[Formatting Explicit Messages](#)” subsection on [Page 6-23](#).

Request Data for Read of Drive Parameter 3

Address	Value (hex)	Description	Refer to . . .
N20:10	0101	TXID = 01, Command = 01 (execute)	6-27
N20:11	0006	Port = 00, Size = 06 bytes	6-27
N20:12	0E01	Service = 0E (Get_Attribute_Single)	B-21
		Address = 01 (Drive Node Address)	6-27
N20:13	00B3	Class = B3 (160 Parameter Table Object)	6-27 , B-18
N20:14	0001	Instance = 1 (Number of Instances)	6-27 , B-18
N20:15	0003	Attribute = 03 (Parameter Number)	6-27 , B-18

Response Data for Read of Drive Parameter 3

Address	Value (hex)	Description	Refer to . . .
N20:50	0101	TXID = 01, Status = 01 (successful)	6-28
N20:51	0002	Port = 00, Size = 02 bytes	6-28
N20:52	8E01	Service = 8E (successful)	6-28
		Address = 01 (Drive Node Address)	
N20:53	0258	Response Data = 600 = 6.00 amperes	—

Request Data for Write to Drive Parameter 30

Address	Value (hex)	Description	Refer to . . .
N20:10	0101	TXID = 01, Command = 01 (execute)	6-27
N20:11	0008	Port = 00, Size = 08 bytes	6-27
N20:12	1001	Service = 10 (Set_Attribute_Single)	B-21
		Address = 01 (Node Address)	6-27
N20:13	00B3	Class = B3 (160 Parameter Table Object)	6-27 , B-18
N20:14	0001	Instance = 1 (Number of Instances)	6-27 , B-18
N20:15	001E	Attribute = 30 (Parameter Number)	6-27 , B-18
N20:16	07D0	Data = 2000 = 20.00 seconds	—

Response Data for Write to Drive Parameter 30

Address	Value (hex)	Description	Refer to . . .
N20:50	0101	TXID = 01, Status = 01 (successful transaction)	6-28
N20:51	0000	Port = 00, Size = 00 bytes	6-28
N20:52	9001	Service = 90 (successful)	6-28
		Address = 01 (Drive Node Address)	

Using Explicit Messaging (Continued)

Important: To originate a scanner transaction, use a copy operation to M0:[slot number]:224. Then, use a copy operation to read M1:1.224 for the result. If more than one message is enabled, use the TXID to determine which message you are reading.

Figure 6.25
SLC Example Explicit Messaging Ladder Logic Program

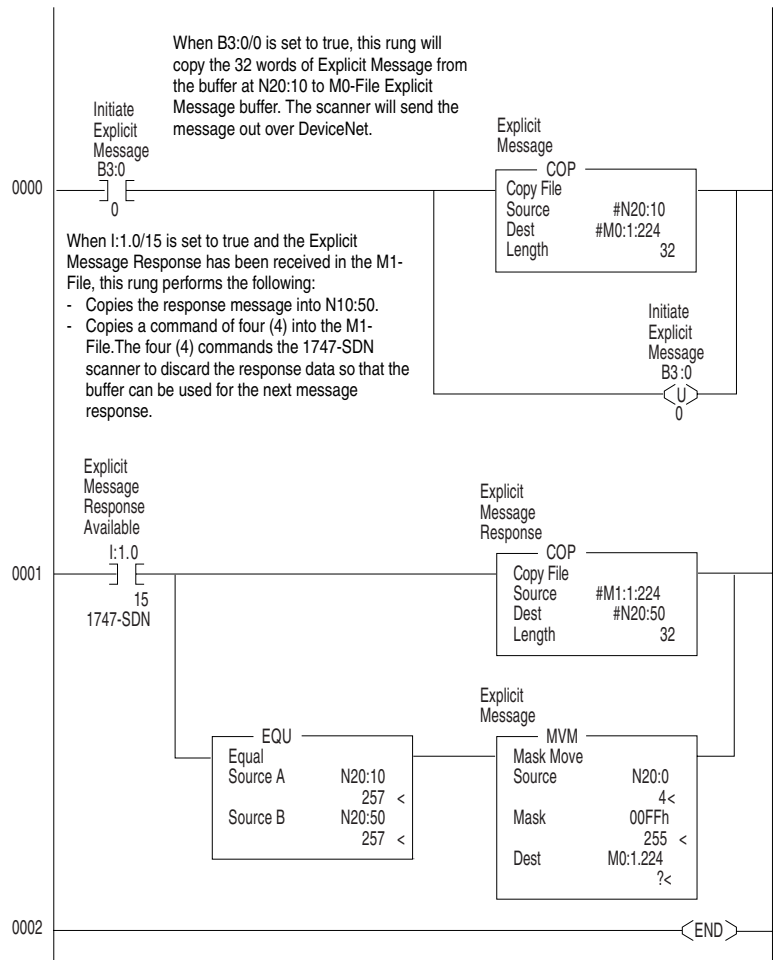

Troubleshooting

This chapter provides information for troubleshooting potential problems with the 160-DN2 DeviceNet Communication Module and network.

Figure 7.1
Module Front View

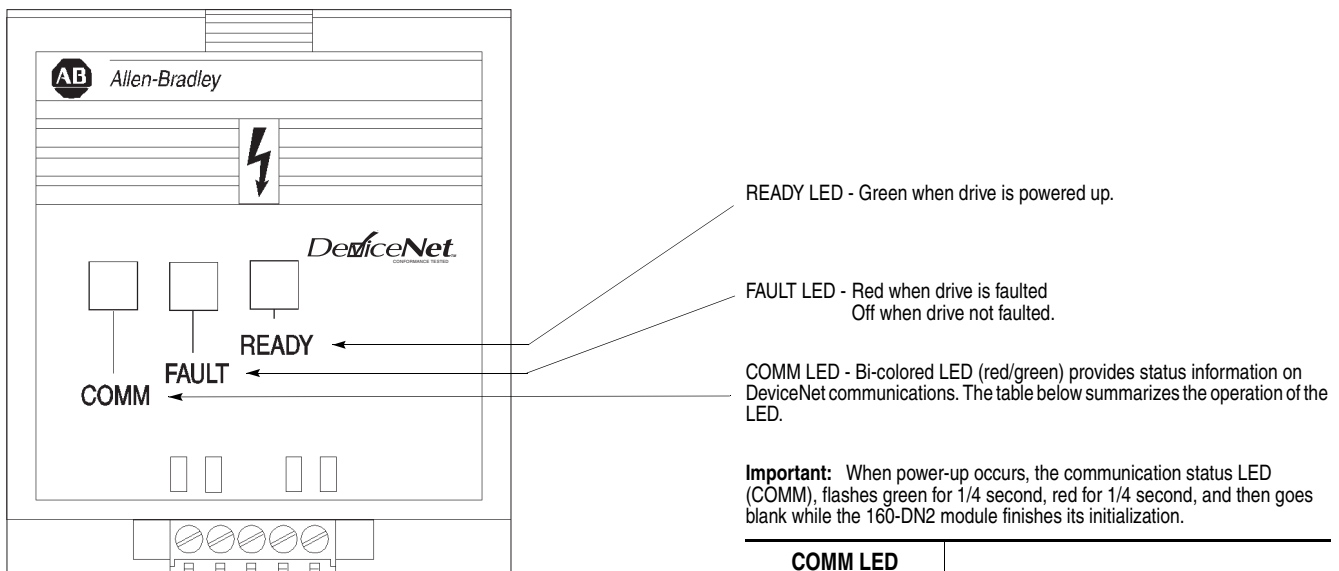

COMM LED		Description
Color	State	
None		No DeviceNet power or initializing.
Red	Solid	Unrecoverable fault.
Red	Flashing	I/O connection has timed out.
Green	Solid	Normal operating state. Device is allocated to a master.
Green	Flashing	Device is on-line but not allocated to a master.



ATTENTION: Servicing energized industrial control equipment can be hazardous. Electrical shock, burns, or unintentional actuation of controlled industrial equipment may cause death or serious injury. Follow the safety-related practices of NPFA 70E, *Electrical Safety for Employee Workplaces*, when working on or near energized equipment. Do not work alone on energized equipment.



ATTENTION: Do not attempt to defeat or override fault circuits. The cause of a fault indication must be determined and corrected before attempting operation. Failure to correct a drive or system malfunction may result in personal injury and/or equipment damage due to uncontrolled machine system operation.

Understanding the COMM LED

The COMM LED provides status information on 160-DN2 module operations. The table below shows how to use the LED to detect and correct common operation problems.

Important: When power up occurs, the COMM LED flashes green for 1/4 second, red for 1/4 second, and then goes blank while the module finishes its initialization.

Table 7.A COMM LED Indications

Color	State	What It Means:	What To Do:
None		The module is not receiving power from the network.	Check DeviceNet power and cable connections and the power connection on the DeviceNet terminal block.
Red	Solid	Diagnostics test failed on power-up/reset. Internal fault exists.	Cycle power to the drive and network. If the fault still exists, return the module for repair.
Red	Solid	There is a duplicate DeviceNet node address. Nodes cannot have the same address.	Reset DIP switches 1 through 6 using a valid address and reset the module. OR If DIP switches 7 and 8 are both set to ON, change the value of P103 - [Nonvolatile MAC ID] to a valid address and reset the module.
Red	Solid	Invalid data rate.	Reset DIP switches 7 and 8 to a valid data rate and reset the module. OR If DIP switches 7 and 8 are both set to ON, change value of P104 - [Nonvolatile Baud Rate] to a valid baud rate and reset the module.
Red	Flashing	I/O connection timed out.	Reset DeviceNet master device.
Green	Solid	Normal operating state and device is allocated to a master.	No action required.
Green	Flashing	Device is on-line but not allocated to a master.	Check DeviceNet master for correct 160-DN2 module configuration information (node address, input assembly, and output assembly).

Understanding the FAULT LED

When the FAULT LED is Red, a drive fault is present. To view the fault code, you must either view **P7 - [Present Fault]** or read the value of Class 0x29 (Control Supervisor Object) Instance 1 Attribute 13 (Fault Code).

If you view **P7 - [Present Fault]**, refer to [Table 7.B](#) for an explanation of each fault code. If you read the value of Attribute 13 (Fault Code), refer to [Table 7.C](#).

Table 7.B Bulletin 160 SSC Interface Fault Codes

Fault Code	Fault Indication	Description	Corrective Action
0	No Fault	The drive is currently not faulted.	No action required.
3	Power Loss	DC Bus voltage remains below 85% nominal on power up for longer than 5 seconds.	Monitor incoming AC line for low voltage or line power interruption.
4	Under Voltage	DC Bus voltage fell below the minimum value while the motor was running.	Monitor incoming AC line for low voltage or line power interruption.
5	Over Voltage	DC Bus maximum voltage exceeded.	Bus overvoltage caused by motor regeneration. Extend the decel time, or install dynamic brake option or external capacitor module. Check for high line voltage.
6	Motor Stalled	Motor has stalled. Motor load is excessive.	Longer accel time or reduced load required.
7	Motor Overload	Internal electronic overload trip. Excessive motor load exists.	Reduce motor load.
8	Over Temperature	Excessive heat detected.	Clear blocked or dirty heat sink fins. Check ambient temperature. Check for blocked or non-operating fan.
11	Operator Fault	The keypad has been removed while the drive is powered or there is excessive noise on the network.	Clear the fault. Do not remove the keypad under power. Eliminate excessive noise on the network.
12	Over Current	Overcurrent detected in hardware trip circuit.	Check short circuit at the drive output or excessive load conditions at the motor.
20	Drive Overload Fault	An internal electronic overload trip has occurred. The drive is over heating.	Clear blocked or dirty heat sink fins. Check ambient temperature. Check for blocked or non-operating fan. Reduce motor load current.
22	Drive Reset	Stop input not present.	Check stop input at TB3 terminal 8.
32	EEPROM Fault	EEPROM has invalid data.	Reset EEPROM using P56 - [Reset Functions] .
33	Max Retries Fault	Drive did not reset fault within the max retries specified.	Repair system fault.
36	Incompatible Fault	Incompatible communication module is installed.	Verify compatibility of communication module.
38	Phase U	Phase to ground fault detected between drive and motor phase U.	Check wiring between drive and motor. Check motor for grounded phase.
39	Phase V	Phase to ground fault detected between drive and motor phase V.	Check wiring between drive and motor. Check motor for grounded phase.
40	Phase W	Phase to ground fault detected between drive and motor phase W.	Check wiring between drive and motor. Check motor for grounded phase.
41	UV Short	Excessive current has been detected between these two drive output terminals.	Check the motor and external wiring to the drive output terminals for a shorted condition.
42	UW Short	Excessive current has been detected between these two drive output terminals.	Check the motor and external wiring to the drive output terminals for a shorted condition.

Understanding the FAULT LED (Continued)

Table 7.B Bulletin 160 SSC Interface Fault Codes (Continued)

Fault Code	Fault Indication	Description	Corrective Action
43	VW Short	Excessive current has been detected between these two drive output terminals.	Check the motor and external wiring to the drive output terminals for a shorted condition.
46	Intermittent Phase Fault	An external short occurred while running diagnostics.	Check wiring between the drive and the motor. Check for more than one shorted output.
48	Reprogramming Fault	Occurs when reset defaults is performed.	Clear fault.
50	No DeviceNet Power	24 volt network power is not detected.	Check DeviceNet connector at module. Also, check the network's power supply.
51	DeviceNet Module EEPROM Fault	DeviceNet 160-DN2 module EEPROM has invalid data.	Reset to factory defaults P56 - [Reset Functions] .
52	DeviceNet Lost I/O Connection	Polled I/O connection timed out.	Check DeviceNet Master for correct operation (i.e., powered up, scanner online, etc.).
53	DeviceNet Unrecoverable Fault	No communication is occurring. Fault occurs when duplicate node address exists or wrong baud rate is set.	Check DIP switch settings for proper baud rate and node address.
54	DeviceNet Transmit Fault	A transmit timeout occurred.	Power drive off and then cycle power on.
55	Forced Fault	Control Supervisor Object (Class Code 0x29) attribute 17 was set to 1.	Clear fault.
56	Drive Incompatibility Fault	The 160-DN2 module is not compatible with the 160 SSC drive firmware version (e.g., Series C FRN 7.02)	Replace the drive.

Table 7.C DeviceNet Fault Codes (Class 0x29, Instance 1, Attribute 13)

Fault Code (hex)	Fault Indication	Description	Corrective Action
1100	Max Retries Fault	Drive failed to reset fault within the maximum retries specified.	Repair system fault.
2213	Power Test	Fault detected during initial start sequence.	Check drive wiring. Check motor wiring. Reset drive to factory defaults.
2220	Over Current	Overcurrent detected in hardware trip circuit.	Check short circuit at the drive output or excessive load conditions at the motor.
2331	Phase U	Phase to ground fault detected between drive and motor phase U.	Check wiring between drive and motor. Check motor for grounded phase.
2332	Phase V	Phase to ground fault detected between drive and motor phase V.	Check wiring between drive and motor. Check motor for grounded phase.
2333	Phase W	Phase to ground fault detected between drive and motor phase W.	Check wiring between drive and motor. Check motor for grounded phase.
2341	UV Short	Excessive current has been detected between these two drive output terminals.	Check the motor and external wiring to the drive output terminals for a shorted condition.

Understanding the FAULT LED (Continued)

Table 7.C DeviceNet Fault Codes (Class 0x29, Instance 1, Attribute 13) (Continued)

Fault Code (hex)	Fault Indication	Description	Corrective Action
2342	UW Short	Excessive current has been detected between these two drive output terminals.	Check the motor and external wiring to the drive output terminals for a shorted condition.
2343	VW Short	Excessive current has been detected between these two drive output terminals.	Check the motor and external wiring to the drive output terminals for a shorted condition.
3120	Power Loss	DC Bus voltage remains below 85% nominal on power up for longer than 5 seconds.	Monitor incoming AC line for low voltage or line power interruption.
3210	Over Voltage	DC Bus maximum voltage exceeded.	Bus overvoltage caused by motor regeneration. Extend the decel time, or install dynamic brake option or external capacitor module. Check for high line voltage.
3220	Under Voltage	DC Bus voltage fell below the minimum value while the motor was running.	Monitor incoming AC line for low voltage or line power interruption.
4310	Over Temperature	Excessive heat detected.	Clear blocked or dirty heat sink fins. Check ambient temperature. Check for blocked or non-operating fan.
5300	Drive Reset	Stop input not present.	Check stop input at TB3 terminal 8.
6310	EEPROM Fault	EEPROM has invalid data.	Reset EEPROM.
6311	DeviceNet Module EEPROM Fault	DeviceNet 160-DN2 module EEPROM has invalid data.	Reset to factory defaults using P56 - [Reset Defaults] .
7121	Motor Stalled	Motor has stalled. Motor load is excessive.	Longer accel time or reduced load required.
7122	Motor Overload	Internal electronic overload trip. Excessive motor load exists.	Reduce motor load.
7421	Reprogramming Fault	Occurs when drive parameters are reset to defaults.	Clear fault.
7500	No DeviceNet Power	24 volt network power is not detected.	Check DeviceNet connector at module. Also, check the network's power supply.
7501	DeviceNet Lost I/O Connection	Polled I/O connection timed out.	Check DeviceNet Master for correct operation (i.e., powered up, scanner online, etc.).
7502	DeviceNet Unrecoverable Fault	No communication is occurring. Fault occurs when duplicate node address exists or wrong baud rate is set.	Check DIP switch settings for proper baud rate and node address.
7503	DeviceNet Transmit Fault	A transmit timeout occurred.	Power drive off, and then cycle power on.
7504	DN Forced Fault	DeviceNet module forced a fault.	Clear fault.

Notes:

Specifications

Electrical

Network Supply Voltage	11 to 25V dc
Node Current Consumption	40 mA maximum ^①
Power Consumption	1W maximum

Environmental

Ambient Temperature Operating Storage	0 to 50° C (32 to 122° F) -40 to 85° C (-40 to 185° F)
Relative Humidity	0 to 95% non-condensing
Vibration	1.0 G operational 2.5 G non-operational
Shock	15.0 G operational 30.0 G non-operational
Altitude	1,000 m (3,300 ft.) without derating

Communications

DeviceNet Baud Rates Distance maximum	125, 250 or 500 kbps 500 m (1640 ft.) @ 125 kbps 200 m (820 ft.) @ 250 kbps 100 m (328 ft.) @ 500 kbps
---	---

Mechanical

Dimensions Height Width Depth ^②	67.5 mm (2.68 in.) 70.0 mm (2.76 in.) 45.4 mm (1.79 in.)
---	--

^① Use this value to size the network current draw from the power supply.

^② When installed on the 160 SSC drive, the communication module adds approximately 21.4 mm (0.85 in.) to the overall depth.

Notes:

DeviceNet Information

The DeviceNet 160-DN2 module enables a Bulletin 160 SSC drive to operate as a slave device on a DeviceNet network. The module supports Explicit Messages and Polled or Change of State/Cyclic I/O Messages of the predefined master/slave connection set. A scanner must be used to properly route messages to a slave device. The 160-DN2 module *does not* support the Explicit Unconnected Message Manager (UCMM).

This appendix defines the DeviceNet Message Types, object classes, class services, and attributes that are supported by the 160-DN2 module.

DeviceNet Message Types

As a group 2 slave device, the module supports these message types:

CAN Identifier Field	Group 2 Message Type
10xxxxx111	Duplicate MAC ID Check Messages
10xxxxx110	Unconnected Explicit Request Messages
10xxxxx101	Master I/O Poll Command Messages
10xxxxx100	Master Explicit Request Messages
10xxxxx011	Slave Explicit Response Messages
01101xxxxx	Slave's I/O Change of State or Cyclic Message
10xxxxx010	Master's Change of State or Cyclic Acknowledge Message
01111xxxxx	Slave Poll Response Messages

xxxxxx = 160-DN2 Module Node Address

CAN Identifier Field	Group 4 Message Types ^①
1111101100	Communication Faulted Response Message
1111101101	Communication Faulted Request Message

^① Dip switches 7 and 8 must be set to "ON" position to enable Group 4 messaging (see pages [3-6](#) and [3-7](#)).

Object Classes

The 160-DN2 module supports these object classes:

Class	Object	Refer to . . .
0x01	Identity	B-3
0x03	DeviceNet	B-5
0x04	Assembly	B-23
0x05	Connection	B-6
0x0F	Parameter	B-9
0x10	Parameter Group	B-11
0x28	Motor Data	B-12
0x29	Control Supervisor	B-13
0x2A	AC Drive	B-16
0x2B	Acknowledge Handler	B-17
0xB3	160 Parameter Table	B-18
0xB4	DeviceNet Interface	B-22

Supported Data Types

The 160-DN2 module supports these data types:

Data Type	Description	Source Length
BYTE	8-bit unsigned integer	1 byte
WORD	16-bit unsigned integer	2 bytes
USINT	8-bit unsigned integer	1 byte
UINT	16-bit unsigned integer	2 bytes
UDINT	32-bit unsigned integer	4 bytes
BOOL	8-bit value -- low bit is true or false	2 bytes
STRING	Array of characters	①
SHORT_STRING	1-byte length indicator + that many characters	

① The source length is determined by the number of data types contained in the array, and the type of each data type.

Class Code 0x01 — Identity Object

Class Attributes

Attribute ID	Access Rule	Name	Data Type	Value
1	Get	Revision	UINT	1
2	Get	Max Instances	UINT	2
6	Get	Max ID Class	UINT	7
7	Get	Max ID Instance	UINT	7

Number of Instances: 2

Instance 1 Attributes: Drive Instance

Attribute ID	Access Rule	Name	Data Type	Value
1	Get	Vendor	UINT	1
2	Get	Product Type	UINT	2
3	Get	Product Code	UINT	—
4	Get	Revision Major Revision Minor Revision	Structure of: USINT USINT	xxxxxxxx X ① X ①
5	Get	Status	WORD	0 = Not owned 1 = Owned by master
6	Get	Serial Number	UDINT	unique number
7	Get	Product Name String Length ASCII String	Structure of: USINT STRING	32 "Bulletin 160 Preset 0.37kW 230V"
9	Get	Configuration Consistency	UINT	Checksum

① For example, firmware revision 5.01 has a major revision of "5" and a minor revision of "1."

Class Code 0x01— Identity Object (Continued)

Instance 2 Attributes: DeviceNet Instance

Attribute ID	Access ID	Name	Data Type	Value
1	Get	Vendor	UINT	1
2	Get	Product Type	UINT	105 = Subassembly
3	Get	Product Code	UINT	1
4	Get	Revision Major Minor	Structure of USINT USINT	3 1
5	Get	Status	WORD	0 = Not Owned 1 = Owned by Master
6	Get	Serial Number	UDINT	Unique 32 bit number
7	Get	Product Name String Length ASCII String	Structure of USINT STRING	16 "Bulletin 160 DN2"

Common Services

Service Code	Implemented for:		Service Name
	Class	Instance	
0x0E	Yes	Yes	Get_Attribute_Single
0x05	No	Yes	Reset

Class Code 0x03 — DeviceNet Object

Class Attributes: None Supported

Number of Instances: 1

Instance 1 Attributes

Attribute ID	Access Rule	Name	Data Type	Value
1	Get/Set	Node Address	USINT	0 to 63
2	Get/Set	Data Rate	USINT	0 to 2
3	Get/Set	BOI	BOOL	0 = Hold in error state on BOI error 1 = Reset CAN chip on BOI error
4	Get/Set	Bus-off Counter	USINT	0 to 255
5	Get	Allocation Info Allocation Choice Master Node Addr	Structure of: BYTE USINT	Allocation_byte ① 0 to 63 = Address 255 = Unallocated
8	Get	MAC ID switch value	USINT	0 to 63
9	Get	Baud Rate switch val	USINT	0 to 3

- ① Allocation_byte
 Bit 0 Explicit Messaging
 Bit 1 Polled I/O
 Bit 4 Change of state
 Bit 5 Cyclic

Common Services

Service Code	Implemented for:		Service Name
	Class	Instance	
0x0E	Yes	Yes	Get_Attribute_Single
0x10	No	Yes	Set_Attribute_Single
0x4B	No	Yes	Allocate_Master/Slave_Connection_Set
0x4C	No	Yes	Release_Master/Slave_Connection_Set

Class Code 0x05 — Connection Object

Class Attributes: None Supported

Number of Instances: 3

Instance 1 Attributes: Explicit Message Instance

Attribute ID	Access Rule	Name	Data Type	Value
1	Get	State	USINT	0 = Nonexistent 1 = Configuring 3 = Established 4 = Timed out 5 = Deferred delete
2	Get	Instance Type	USINT	0 = Explicit Message
3	Get	Transport Class Trigger	USINT	0x83
4	Get	Produced Connection ID	UINT	10xxxxxx100 where xxxxxx = Node address
5	Get	Consumed Connection ID	UINT	10xxxxxx100 where xxxxxx = Node address
6	Get	Initial Comm. Characteristics	USINT	0x22
7	Get	Produced Connection Size	UINT	7
8	Get	Consumed Connection Size	UINT	7
9	Get/Set	Expected Packet Rate	UINT	Timer resolution of 10 msec.
12	Get/Set	Watchdog Action	USINT	1 = Auto delete 3 = Deferred delete
13	Get	Produced Connection Path Length	UINT	0
14	Get	Produced Connection Path		Null (no data)
15	Get	Consumed Connection Path Length	UINT	0
16	Get	Consumed Connection Path		Null (no data)

Class Code 0x05 — Connection Object (Continued)

Instance 2 Attributes: Polled I/O Message Connection

Attribute ID	Access Rule	Name	Data Type	Value
1	Get	State	USINT	0 = Nonexistent 1 = Configuring 3 = Established 4 = Timed out
2	Get	Instance Type	USINT	1 = I/O Message
3	Get	Transport Class Trigger	USINT	0x82
4	Get	Produced Connection ID	UINT	10xxxxxx100 where xxxxxx = Node address
5	Get	Consumed Connection ID	UINT	10xxxxxx101 where xxxxxx = Node address
6	Get	Initial Comm Characteristics	USINT	0x21
7	Get	Produced Connection Size	UINT	0 to 8
8	Get	Consumed Connection Size	UINT	0 to 4
9	Get/Set	Expected Packet Rate	UINT	Timer resolution of 10 msec.
12	Get/Set	Watchdog Action	USINT	0 = Transition to timed out 1 = Auto delete 2 = Auto reset
13	Get	Produced Connection Path Length	UINT	3
14	Get/Set	Produced Connection Path		[63hex][hex string] where [hex string] is the input assembly number in hex
15	Get	Consumed Connection Path Length	UINT	3
16	Get/Set	Consumed Connection Path		[63hex][hex string] where [hex string] is the output assembly number in hex

Class Code 0x05 — Connection Object (Continued)

Instance 4 Attributes: Change of State/Cyclic Instance

Attribute ID	Access Rule	Name	Data Type	Value
1	Get	State	USINT	0 = Nonexistent 1 = Configuring 3 = Established 4 = Timed out
2	Get	Instance Type	USINT	1 = I/O Message
3	Get	Transport Class Trigger	USINT	0x82
4	Get	Produced Connection ID	UINT	10xxxxxx100 where xxxxxx = Node address
5	Get	Consumed Connection ID	UINT	10xxxxxx101 where xxxxxx = Node address
6	Get	Initial Comm Characteristics	USINT	0x21
7	Get	Produced Connection Size	UINT	0 to 8
8	Get	Consumed Connection Size	UINT	0 to 4
9	Get/Set	Expected Packet Rate	UINT	timer resolution of 10 msec.
12	Get/Set	Watchdog Action	USINT	0 = transition to timed out 1 = auto delete 2 = auto reset
13	Get	Produced Connection Path Length	UINT	3
14	Get/Set	Produced Connection Path		[63hex][hex string] where [hex string] is the input assembly number in hex
15	Get	Consumed Connection Path Length	UINT	3
16	Get/Set	Consumed Connection Path		[63hex][hex string] where [hex string] is the output assembly number in hex
17	Get/Set	Production Inhibit Time	UINT	0

Common Services

Service Code	Implemented for:		Service Name
	Class	Instance	
0x05	No	Yes	Reset
0x0E	Yes	Yes	Get_Attribute_Single
0x10	No	Yes	Set_Attribute_Single

Class Code 0x0F — Parameter Object

Class Attributes

Attribute ID	Access Rule	Name	Data Type	Value
1	Get	Revision	UINT	1
2	Get	Max Instance	UINT	118
8	Get	Parameter Class Descriptor	WORD	0x0B
9	Get	Configuration Assembly Instance	UINT	190
10	Get	Native Language	USINT	0 = English

Number of Instances: 118

Instance 1 through 118 Attributes

Attribute ID	Access Rule	Name	Data Type	Value
1	Set	Parameter Value	data type specified in Descriptor, Data Type and Data Size	①
2	Get	Link Path Size	USINT	①
3	Get	Link Path	ARRAY of DeviceNet path	6 "20 B3 24 01 30 01" ①
		Segment type/port	BYTE	
		Segment Address	path	
4	Get	Descriptor	WORD	①
5	Get	Data Type	USINT	①
6	Get	Data Size	USINT	①
7	Get	Parameter Name String	SHORT_STRING	①
8	Get	Units String	SHORT_STRING	①
9	Get	Help String	SHORT_STRING	①
10	Get	Minimum Value	data type	①
11	Get	Maximum Value	data type	①
12	Get	Default Value	data type	①
13	Get	Scaling Multiplier	UINT	①
14	Get	Scaling Divisor	UINT	①
15	Get	Scaling Base	UINT	①
16	Get	Scaling Offset	INT	①
17	Get	Multiplier Link	UINT	①

① Value varies based on parameter instance.

Class Code 0x0F — Parameter Object (Continued)

Instance 1 through 118 Attributes (Continued)

Attribute ID	Access Rule	Name	Data Type	Value
18	Get	Divisor Link	UINT	①
19	Get	Base Link	UINT	①
20	Get	Offset Link	UINT	①
21	Get	Decimal Precision	USINT	①

① Value varies based on parameter instance.

Common Services

Service Code	Implemented for:		Service Name
	Class	Instance	
0x0E	Yes	Yes	Get_Attribute_Single
0x10	No	Yes	Set_Attribute_Single
0x01	Yes	Yes	Get_Attributes_All
0x4B	No	Yes	Get_Enum_String

Class Code 0x10 — Parameter Group Object

Class Attributes

Attribute ID	Access Rule	Name	Data Type	Value
1	Get	Revision	UINT	1
2	Get	Max Instance	UINT	3
8	Get	Native Language	USINT	0 = English

Number of Instances: 3

Instance 1 through 3 Attributes

Attribute ID	Access Rule	Name	Data Type	Value
1	Get	Group Name String	SHORT_STRING	①
2	Get	Number of members in group	UINT	①
3	Get	1st Parameter Number in Group	UINT	①
4	Get	2nd Parameter Number in Group	UINT	①
n	Get	(n-2)th Parameter Number in Group	UINT	①

① Value varies based on parameter group instance.

Common Services

Service Code	Implemented for:		Service Name
	Class	Instance	
0x0E	Yes	Yes	Get_Attribute_Single
0x01	Yes	Yes	Get_Attributes_All

Class Code 0x28 — Motor Data Object

Class Attributes: None Supported

Number of Instances: 1

Instance 1 Attributes

Attribute ID	Access Rule	Name	Data Type	Min/Max	Units	Default	Description
6	Get/Set	Rated Current	UINT	0 to 100.00	0.01 Amps	115% of Drive Rating	Rated Stator Current (from motor nameplate)
7	Get/Set	Rated Voltage	UINT	110 to 460	1 Volt	Drive Rating	Rated Base Voltage (from motor nameplate)
9	Get/Set	RatedFreq	UINT	10 to 240	1 Hz	60 Hz	Rated Electrical Frequency (from motor nameplate)
15	Get/Set	BaseSpeed	UINT	200 to 32000	1 RPM	1800 RPM	Nominal Speed at Rated Frequency (from motor nameplate)

Common Services

Service Code	Implemented for:		Service Name
	Class	Instance	
0x0E	No	Yes	Get_Attribute_Single
0x10	No	Yes	Set_Attribute_Single

Class Code 0x29 — Control Supervisor Object

Class Attributes: None Supported

Number of Instances: 1

Instance 1 Attributes

Attribute ID	Access Rule	Name	Data Type	Min/Max	Default	Description
3	Get/Set	RunFwd	BOOL	0 to 1	0	See page B-15 .
4	Get/Set	RunRev	BOOL	0 to 1	0	See page B-15 .
5	Get/Set	NetCtrl	BOOL	0 to 1	0	See page B-15 .
6	Get	State	USINT	0 to 7		3 = Ready 4 = Enabled 7 = Faulted (See Figure B.1 on page B-14 .)
7	Get	RunningFwd	BOOL	0 to 1	0	1 = (Enabled and RunFwd) 0 = Other State
8	Get	RunningRev	BOOL	0 to 1	0	1 = (Enabled and RunRev) 0 = Other State
9	Get	Ready	BOOL	0 to 1		1 = Ready or Enabled 0 = Other State
10	Get	Faulted	BOOL	0 to 1		1 = Fault Latched 0 = No faults present
12	Get/Set	FaultRst	BOOL	0 to 1	0	0 -> 1 = Fault Reset 0 = No Action
13	Get	FaultCode	UINT	0 to 7504hex	0	In Faulted state, FaultCode indicates the fault that caused the transition to Faulted . If not in Faulted state, FaultCode indicates the fault that caused the last transition to the Faulted state. Fault codes are listed in <i>Chapter 7, Table 7.B</i> .
15	Get	CtrlFromNet	USINT	0 to 1	0	Status of Run/Stop control source. 0 = Control is Local 1 = Control is from the network
16	Get/Set	DNFaultMode	USINT	0 to 1	0	Mode that determines the drive's behavior when a communication fault such as loss of DeviceNet power occurs. 0 = Fault the drive and issue a stop command 1 = Ignore the communication fault
17	Get/Set	Force Fault/Trip	BOOL	0 to 1	0	0 to 1 transition forces fault.
100 ①②	Get/Set	OutputAssembly	USINT	0 to 103	20	Output Assembly instance that is currently active.
101 ①②	Get/Set	InputAssembly	USINT	0 to 105	70	Input Assembly instance that is currently active.
102 ①	Get/Set	DNPreSetCmd	USINT	0 to 7	0	DeviceNet Preset command. (Preset Speed Units Only.)

① Bulletin 160 specific instance attributes.

② Setting Attribute *ID 100* to "0" will cause the slave to expect no control information from the master. Likewise, setting Attribute *ID 101* to "0" will cause the master to expect no status information from the slave.

**Class Code 0x29 —
Control Supervisor Object
(Continued)**

Common Services

Service Code	Implemented for:		Service Name
	Class	Instance	
0x0E	No	Yes	Get_Attribute_Single
0x10	No	Yes	Set_Attribute_Single

State Transition Diagram

The following State Transition Diagram provides a graphical description of the states and state transitions that are described for attribute 6 on page [B-13](#).

**Figure B.1
State Transition Diagram**

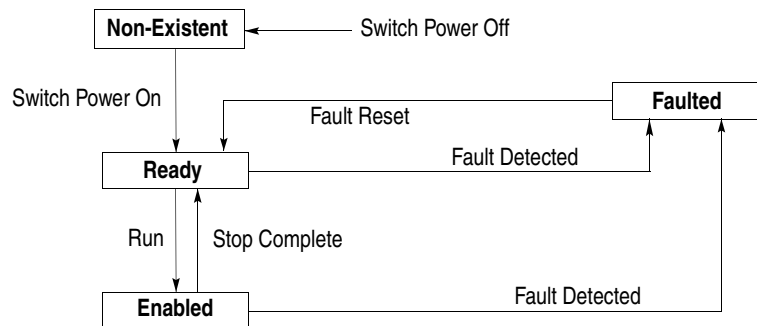

**Class Code 0x29 —
Control Supervisor Object
(Continued)**

Run/Stop Event Matrix

Attribute 5, NetCtrl is used to request that Run/Stop events be controlled from the network. However, before Run/Stop control is accomplished from the network, these things must occur:

- Attribute 15, CtrlFromNet is set to 1 by the device in response to a NetCtrl request.
- Power is cycled.

If attribute 15, CtrlFromNet is set to 1, the events Run and Stop are triggered by a combination of the RunFwd and RunRev attributes as shown in this table:

RunFwd	RunRev	Trigger Event	Run Type
0	0	Stop	NA
0 -> 1	0	Run	RunFwd
0	0 -> 1	Run	RunRev
0 -> 1	0 -> 1	No Action	NA
1	1	No Action	NA
1->0	1	Run	RunRev
1	1->0	Run	RunFwd

Important: Local Stop commands from the TB3 terminal block on the drive override Run/Stop control through the DeviceNet network.

Important: When attempting to use attribute 3 or 4 to start the drive, the Explicit Message connection (Class 5, instance 1) attribute 9, Expected Packet Rate must be set to greater than zero.

Class Code 0x2A — AC Drive Object

Class Attributes: None Supported

Number of Instances: 1

Instance 1 Attributes

Attribute ID	Access Rule	Name	Data Type	Min/Max	Units	Default	Description
3	Get	AtReference	BOOL	0 to 1		0	Set to 1 when SpeedActual is equal to SpeedRef.
4	Get/Set	NetRef	BOOL	0 to 1		0	1 = Drive uses SpeedRef (attribute 8) as its speed reference. 0 = Drive gets its speed reference from local terminal block 3.
6	Get	Drive Mode	USINT	1		1	1 = Open Loop Frequency control.
7	Get	SpeedActual	INT	0 to 32000	1 RPM	0	Actual speed command in RPM.
8	Get/Set	SpeedRef	INT	0 to 32000	1 RPM	1800 RPM	Speed reference in RPM.
9	Get	CurrentActual	INT	0 to 32000	0.01 Amp		Actual motor phase current in amperes.
10	Get/Set	CurrentLimit	INT	0 to 32000	0.01 Amp	180% of rating	Motor phase current limit in amperes.
15	Get	PowerActual	INT	0 to 32000	1 Watt		Actual drive output power in Watts.
16	Get	InputVoltage	INT	0 to 460	1 Volt	230V or 460V	Input voltage rating.
17	Get	OutputVoltage	INT	0 to 460	1 Volt		Output voltage to the motor.
18	Get/Set	AccelTime	UINT	100 to 65500	1 mSec	10000	Time to accelerate from 0 to HighSpeed Limit.
19	Get/Set	DecelTime	UINT	100 to 65500	1 mSec	10000	Time to decelerate from HighSpeed Limit to 0.
20	Get/Set	LowSpeed Limit	UINT	0 to 32000	1 RPM	0 RPM	Minimum Speed Limit in RPM.
21	Get/Set	HighSpeed Limit	UINT	0 to 32000	1 RPM	1800 RPM	Maximum Speed Limit in RPM.
29	Get	RefFromNet	BOOL	0 to 1		0	Status of Network Speed Reference. 1 = Drive uses SpeedRef. 0 = Drive uses local reference.
Bulletin 160 SSC Specific Extensions	The AC Drive Object includes in its implementation a variable number of 160 SSC specific instance attributes. By adding the number 100 to any parameter number in the Bulletin 160 parameter table, the resulting number will be a 160 SSC specific instance attribute in the AC Drive Object. For example, in the 160 SSC drive, parameter 5 displays Bus Voltage. Therefore, attribute # 105 of the AC Drive Object returns Bus Voltage. This method of extending the AC Drive Object allows for an ODVA compliant implementation of the Drive Profile, and accommodates all Bulletin 160 SSC models (both analog and preset speed models). Refer to the <i>Bulletin 160 SSC User Manual, Chapter 5</i> .						

Common Services

Service Code	Implemented for:		Service Name
	Class	Instance	
0x0E	No	Yes	Get_Attribute_Single
0x10	No	Yes	Set_Attribute_Single

Class Code 0x2B — Acknowledge Handler Object

Class Attributes: None Supported	Number of Instances: 1
---	-------------------------------

Instance 1 Attributes

Attribute ID	Access Rule	Name	Data Type	Min/Max	Default
1	Get/Set	Acknowledge Timer	UINT	1 to 65,535	16 ms
2	Get/Set	Retry Limit	USINT	0 to 255	1
3	Get/Set	COS Producing Connection Instance	UINT		4

Common Services

Service Code	Implemented for:		Service Name
	Class	Instance	
0x0E	No	Yes	Get_Attribute_Single
0x10	No	Yes	Set_Attribute_Single

Class Code 0xB3 — 160 Parameter Table Object

Class Attributes: None Supported

Number of Instances: 1

Instance 1 Attributes

Attribute ID	Access Rule	Parameter Name	Data Type	Units	Description
This Bulletin 160 SSC specific object implements all of the parameters in the 160 SSC parameter table as instance attributes of the object. For example, attribute #1 corresponds to P01 - [Output Frequency] . This enables you to configure a drive via DeviceNet using attribute numbers that are published as parameter numbers in the <i>Bulletin 160 SSC User Manual</i> .					
Important: Attributes 9 and 12 shown below <i>do not</i> match what is published in the <i>Bulletin 160 SSC User Manual</i> .					
01	Get	[Output Frequency]	UINT	0.1 Hz	Frequency at TB2 terminals T1, T2, T3.
02	Get	[Output Voltage]	UINT	1 Volt	Voltage at TB2 terminals T1, T2, T3.
03	Get	[Output Current]	UINT	0.01 Amperes	Current at TB2 terminals T1, T2, T3.
04	Get	[Output Power]	UINT	0.01 kW	Power at TB2 terminals T1, T2, T3.
05	Get	[Bus Voltage]	UINT	1 Volt	DC Bus voltage level.
06	Get	[Cmd Frequency]	UINT	0.1 Hz	Commanded frequency.
07	Get	[Present Fault]	USINT	Numeric Value	Coded last fault number.
08	Get	[Heatsink Temp]	USINT	1 C	Temperature of the drive heatsink.
09	Get	[Drive Status]	WORD	Binary Number	Status of drive in binary coded format.
10	Get	[Drive Type]	USINT	Numeric Value	Used by Allen-Bradley field service personnel.
11	Get	[Control Version]	UINT	Numeric Value	version of drive firmware used.
12	Get	[Input Status]	WORD	Binary Number	Open (0) Closed (1) state of drive's discrete inputs.
13	Get	[Power Factor Ang]	UINT	0.1	Angle (electrical degrees) between V and I.
14	Get	[Memory Probe]	UINT	Numeric Value	Used by Allen-Bradley service personnel.
15	Get	[Preset Status]	WORD	Binary Number	Displays state of TB3 inputs.
16	Get	[Analog Input]	INT	0.1%	The analog input as a percent of full scale.
17	Get	[Fault Buffer 0]	USINT	Numeric Value	Stores the most recent fault.
18	Get	[Fault Buffer 1]	USINT	Numeric Value	Stores the second most recent fault.
19	Get	[Fault Buffer 2]	USINT	Numeric Value	Stores the third most recent fault.
30	Get/Set	[Accel Time 1]	UINT	0.1 Seconds	Time to ramp from 0 Hz to maximum frequency.
31	Get/Set	[Decel Time 1]	UINT	0.1 Seconds	Time to ramp from maximum frequency to 0 Hz.
32	Get/Set	[Minimum Freq]	USINT	1 Hz	Lowest continuous output frequency.
33	Get/Set	[Maximum Freq]	UINT	1 Hz	Highest continuous output frequency.
34	Get/Set	[Stop Mode Select]	USINT	Numeric Value	Determines stop mode used.
					 <p>ATTENTION: Changing this parameter value may cause unpredictable network conditions, resulting in equipment damage, personal injury, or death. Make sure that you understand how changing this parameter affects your application.</p>

Class Code 0xB3 — 160 Parameter Table Object (Continued)

Attribute ID	Access Rule	Parameter Name	Data Type	Units	Description
35	Get/Set	[Base Frequency]	UINT	1 Hz	Set to motor's nameplate frequency.
36	Get/Set	[Base Voltage]	UINT	1 Volt	Set to motor's nameplate voltage.
37	Get/Set	[Maximum Voltage]	UINT	1 Volt	Highest voltage the drive will output.
38	Get/Set	[Boost Select]	USINT	Numeric Value	Sets the volts/Hz relationship.
39	Get/Set	[Skip Frequency]	UINT	1 Hz	Frequency at which drive will not run continuously.
40	Get/Set	[Skip Freq Band]	USINT	1 Hz	Used with P39 - [Skip Frequency] to create skip band.
41	Get/Set	[Overload Select]	USINT	Numeric Value	Selects derating factor for motor overload.
42	Get/Set	[Motor Overload]	UINT	0.01 Amperes	Set to nameplate full load Amperes.
43	Get/Set	[Current Limit]	USINT	% I rating	Max output current allowed before limiting.
44	Get/Set	[DC Hold Time]	USINT	0.1 Seconds	DC Injection Braking duration.
45	Get/Set	[DC Hold Voltage]	USINT	1 Volt	Voltage level for DC Injection Braking.
46	Get/Set	[Input Mode]	USINT	Numeric Value	Type of START, STOP and REV commands. <div style="border: 1px solid black; padding: 5px; display: inline-block;">  <p>ATTENTION: Changing this parameter value may cause unpredictable network conditions, resulting in equipment damage, personal injury, or death. Make sure that you understand how changing this parameter affects your application.</p> </div>
47	Get/Set	[Output Configure]	USINT	Numeric Value	Configures TB3 output relay functionality.
48	Get/Set	[Output Threshold]	UINT	Numeric Value	Used in conjunction with P47 - [Output Configure].
49	Get/Set	[PWM Frequency]	USINT	0.1 kHz	Carrier Frequency for PWM output waveform.
50	Get/Set	[Restart Tries]	USINT	Numeric Value	Times drive will attempt to reset a fault.
51	Get/Set	[Restart Time]	UINT	0.1 Seconds	Time between restart attempts.
52	Get/Set	[DB Enable]	USINT	Numeric Value	Enables/Disables dynamic braking.
53	Get/Set	[S-Curve]	USINT	Numeric Value	Enables a fixed shape S-curve.
54	Get/Set	[Clear Fault]	BOOL	Numeric Value	Setting to 1 performs a fault reset.
55	Get/Set	[Probe Address]	UINT	Numeric Value	Used by Allen-Bradley service personnel.
56	Get/Set	[Reset Functions]	USINT	Numeric Value	Sets all parameters to their factory default.
57	Get/Set	[Program Lock]	BOOL	Numeric Value	Locks all program group parameters.
58	Get/Set	[Internal Freq]	UINT	0.1 Hz	Digital Frequency setpoint.
59	Get/Set	[Freq Select]	BOOL	Numeric Value	Selects source of frequency command.

Class Code 0xB3 — 160 Parameter Table Object (Continued)

Attribute ID	Access Rule	Parameter Name	Data Type	Units	Description
60	Get/Set	[Zero Offset]	INT	Numeric Value	Add or subtracts an offset to the analog input.
60	Get/Set	[DN Preset Cmd]	USINT	Numeric Value	Network preset command.
61	Get/Set	[Preset Freq 0]	UINT	0.1 Hz	Sets command frequency when selected.
62	Get/Set	[Preset Freq 1]	UINT	0.1 Hz	Sets command frequency when selected.
63	Get/Set	[Preset Freq 2]	UINT	0.1 Hz	Sets command frequency when selected.
64	Get/Set	[Preset Freq 3]	UINT	0.1 Hz	Sets command frequency when selected.
65	Get/Set	[Preset Freq 4]	UINT	0.1 Hz	Sets command frequency when selected.
66	Get/Set	[Preset Freq 5]	UINT	0.1 Hz	Sets command frequency when selected.
67	Get/Set	[Preset Freq 6]	UINT	0.1 Hz	Sets command frequency when selected.
68	Get/Set	[Preset Freq 7]	UINT	0.1 Hz	Sets command frequency when selected.
69	Get/Set	[Accel Time 2]	UINT	0.1 Seconds	Sets acceleration rate for presets 4 to 7.
70	Get/Set	[Decel Time 2]	UINT	0.1 Seconds	Sets deceleration rate for presets 4 to 7.
71	Get/Set	[IR Compensation]	USINT	1%	Adds a voltage to the output based on the torque current.
72	Get/Set	[Slip Comp]	USINT	0.1 Hz	Compensates for the inherent slip of the motor.
73	Get/Set	[Reverse Disable]	BOOL	Numeric Value	Setting to 1 disables the reverse.
74	Get/Set	[Analog Select]	BOOL	Numeric Value	Selects between unipolar and bipolar analog input.
75	Get/Set	[Analog Minimum]	INT	0.1%	Sets the percent of the analog input used to represent P32 - [Minimum Freq] .
76	Get/Set	[Analog Maximum]	INT	0.1%	Sets the percent of the analog input used to represent P33 - [Maximum Freq] .
78	Get/Set	[Compensation]	BOOL	Numeric Value	Setting to 1 enables the compensation.
79	Get/Set	[Current Trip]	USINT	1%	Percent above P43 - [Current Limit] at which the drive trips immediately.
80	Get/Set	[Stall Disable]	USINT	Numeric Value	Time drive is in stall condition before causing a stall fault.
81	Get/Set	[Proc Kp Gain]	UINT	Numeric Value	Proportional gain used by the PI regulator.
82	Get/Set	[Proc Ki Gain]	UINT	Numeric Value	Integral gain used by the PI regulator.
83	Get/Set	[Proc Reference]	UINT	Numeric Value	Set point value to which PI control will regulate.
84	Get/Set	[Proc Invert]	USINT	Numeric Value	The PI control will ignore errors less than this value.

This parameter applies only to the Analog Signal Follower model.

This parameter applies only to the Preset Speed model.

**Class Code 0xB3 —
160 Parameter Table Object
(Continued)**

Common Services

Service Code	Implemented for:		Service Name
	Class	Instance	
0x0E	No	Yes	Get_Attribute_Single
0x10	No	Yes	Set_Attribute_Single

Class Code 0xB4 — DN Interface Object

Class Attributes: None Supported

Number of Instances: 1

Instance 1 Attributes

Attribute ID	Access Rule	Name	Data Type	Min/Max	Default	Description
1	Get	Zero	USINT	0	0	Returns zero.
2	Get	Interface Select	USINT	0	0	0 = <i>Bulletin 160 SSC Interface</i> .
3	Get	MAC ID Switches	USINT	0 to 63		Reflects the state of the MAC ID switches.
4	Get	Baud Switches	USINT	0 to 3		Reflects the state of the Baud Rate switches.
5	Get/Set	Nonvolatile MAC ID	USINT	0 to 63	63	Stored value of the MAC ID. This value is used when Baud Rate Switches 7 and 8 are ON.
6	Get/Set	Nonvolatile Baud	USINT	0 to 2	0	Stored value of Baud Rate. This value is used when Baud Rate Switches 7 and 8 are ON.
7 ①	Get/Set	Assembly Word 0 Param	USINT	0 to 88	9	<i>Bulletin 160 SSC Interface</i> parameter number whose value is used as the first word in Input Assembly 102.
8 ①	Get/Set	Assembly Word 1 Param	USINT	0 to 88	0	<i>Bulletin 160 SSC Interface</i> parameter number whose value is used as the second word in Input Assembly 102.
9 ①	Get/Set	Assembly Word 2 Param	USINT	0 to 88	0	<i>Bulletin 160 SSC Interface</i> parameter number whose value is used as the third word in Input Assembly 102.
10 ①	Get/Set	Assembly Word 3 Param	USINT	0 to 88	0	<i>Bulletin 160 SSC Interface</i> parameter number whose value is used as the fourth word in Input Assembly 102.
11	Get/Set	DN Idle Mode	BOOL	0 to 1	0	0 = Stop, 1 = Hold Last State.
12	Get	DN Software Version	WORD	0.00 to 10.00	2.00	Indicates the software version of the DeviceNet option.
13	Get/Set	DN Change of State Mask	WORD	0 to 0xFFFF	0xFFFF	A 16 bit mask used to enable automatic change of state messages.
14	Get/Set	Local Return Mode	BYTE	0 to 5	0	Sets the input mode the drive will use when transitioning from network to local control.
15	Get	DeviceNet DIP Switches	BYTE	0 to 255		Current DIP switch settings on the 160-DN2 module.

- ① If set to a "9," **P9 - [Drive Status]** (of the SSC Interface Profile) goes in the low byte of the assembly field, and **P12 - [Input Status]** (of the SSC Interface Profile) goes in the high byte of the assembly field.

Common Services

Service Code	Implemented for:		Service Name
	Class	Instance	
0x0E	No	Yes	Get_Attribute_Single
0x10	No	Yes	Set_Attribute_Single

Class Code 0x04 — Assembly Objects

Class Attributes: None Supported	Number of Instances: 19
---	--------------------------------

Instance 1 to 105 Attributes: I/O Instances

Attribute ID	Access Rule	Name	Data Type	Min/Max	Default	Description
3	Get	Data				See instance data format for individual I/O assemblies on pages B-24 through B-28 .

Instance 191 to 193 Attributes: Configuration Instances

Attribute ID	Access Rule	Name	Data Type	Min/Max	Default	Description
3	Get/Set	Data				See configuration assembly data formats for individual configuration assemblies on pages B-29 and B-30 .

Common Services

Service Code	Implemented for:		Service Name
	Class	Instance	
0x0E	No	Yes	Get_Attribute_Single
0x10	No	Yes	Set_Attribute_Single

Class Code 0x04 — Assembly Objects (Continued)

Instance Data Format: Output Assemblies

Instance 1 Data Format (Basic Contactor Output Assembly)								
Byte	Bit 7	Bit 6	Bit 5	Bit 4	Bit 3	Bit 2	Bit 1	Bit 0
0								Run

Instance 2 Data Format (Basic Overload Output Assembly)								
Byte	Bit 7	Bit 6	Bit 5	Bit 4	Bit 3	Bit 2	Bit 1	Bit 0
0						Fault Reset		

Instance 3 Data Format (Basic Motor Starter Output Assembly)								
Byte	Bit 7	Bit 6	Bit 5	Bit 4	Bit 3	Bit 2	Bit 1	Bit 0
0						Fault Reset		Run

Instance 4 Data Format (Extended Contactor Output Assembly)								
Byte	Bit 7	Bit 6	Bit 5	Bit 4	Bit 3	Bit 2	Bit 1	Bit 0
0							RunRev	RunFwd

Instance 5 Data Format (Extended Motor Starter Output Assembly)								
Byte	Bit 7	Bit 6	Bit 5	Bit 4	Bit 3	Bit 2	Bit 1	Bit 0
0						Fault Reset	RunRev	RunFwd

Instance 20 Data Format (Basic Speed Control Output Assembly)								
Byte	Bit 7	Bit 6	Bit 5	Bit 4	Bit 3	Bit 2	Bit 1	Bit 0
0						Fault Reset		RunFwd
1								
2 ①								Speed Reference RPM (Low Byte) ②
3 ①								Speed Reference RPM (High Byte) ②

Instance 21 Data Format (Reversing Speed Control Output Assembly)								
Byte	Bit 7	Bit 6	Bit 5	Bit 4	Bit 3	Bit 2	Bit 1	Bit 0
0		NetRef ③④	Net Control ③⑤			Fault Reset	RunRev	RunFwd
1								
2 ①								Speed Reference RPM (Low Byte) ②
3 ①								Speed Reference RPM (High Byte) ②

Instance 100 Data Format (Reversing Speed Control Output Assembly (Hz))								
Byte	Bit 7	Bit 6	Bit 5	Bit 4	Bit 3	Bit 2	Bit 1	Bit 0
0						Fault Reset	RunRev	RunFwd
1								
2 ①								Internal Frequency (0.1 Hz) (Low Byte) ⑥
3 ①								Internal Frequency (0.1 Hz) (High Byte) ⑥

① If speed references are outside of their min/max limits, the drive ignores them and previous speed references will be maintained.

② 0 – 32000 RPM. The RPM value is limited by the value programmed into P33 - [Maximum Frequency].

③ Must set bit 5 and bit 6 high before issuing bit 0 or bit 1.

④ If bit is set to a 0, the drive looks to TB2 for speed reference control. If bit is set to 1, the drive looks to the network for speed reference control.

⑤ If bit is set to 0 (low), parameter 118 will pass its value to parameter 46. If bit is set to 1 (high), parameter 118 will be ignored, and parameter 46 will stay “network control.”

⑥ 0 = 0 Hz, 2400 = 240.0 Hz. The frequency value is limited by the value programmed into P33 - [Maximum Frequency].

Class Code 0x04 — Instance Data Format: Output Assemblies (Continued) Assembly Objects (Continued)

Instance 101 Data Format (Preset Control) (Preset Speed Units Only) ^①								
This output assembly type is only available for use with Preset Speed Units.								
Byte	Bit 7	Bit 6	Bit 5	Bit 4	Bit 3	Bit 2	Bit 1	Bit 0
0						Fault Reset	RunRev	RunFwd
1	DN Preset Cmd							
	(DN Preset Cmd contains these three bits)					Preset 2 ^{②③} (acts like TB2-4 or SW3)	Preset 1 ^{②③} (acts like TB2-2 or SW2)	Preset 0 ^{②③} (acts like TB2-1 or SW1)

Instance 103 Allen-Bradley Drive Output Assembly								
This output assembly mirrors the 1305/1336 IO format.								
Byte	Bit 7	Bit 6	Bit 5	Bit 4	Bit 3	Bit 2	Bit 1	Bit 0
0	N/A	N/A	Direction ^④	Direction ^④	Clear Faults	N/A	Start	Stop
1	N/A	Reference Select ^⑤	Reference Select ^⑤	Reference Select ^⑤	N/A	N/A	N/A	N/A
2	Scale Speed Reference (Low Byte) ^⑥							
3	Scale Speed Reference (High Byte) ^⑥							

① Net Ref has higher priority than Net Control. Therefore, if Net Ref is set, presets are ignored.

② For Preset Speed Units: Net Ref determines if speed reference comes from the network or preset speeds.

③ Preset Speed

TB3-4 (SW3)	TB3-2 (SW2)	TB3-1 (SW1)	
0	0	0	Preset 0
0	0	1	Preset 1
0	1	0	Preset 2
0	1	1	Preset 3
1	0	0	Preset 4
1	0	1	Preset 5
1	1	0	Preset 6
1	1	1	Preset 7

④ Direction

Bit 5	Bit 4	
0	0	No Command
0	1	Forward Command
1	0	Reverse Command
1	1	Hold Direction Cmd

⑤ Reference Select

Bit 14	Bit 13	Bit 12	
0	0	0	No Command Select
0	0	1	TB3 Control
0	1	0	Network Control
0	1	1	Preset 3
1	0	0	Preset 4
1	0	1	Preset 5
1	1	0	Preset 6
1	1	1	Preset 7

⑥ 0 = 0 Hz, 32767 = Maximum Frequency (Hz)

The following table indicates the I/O Assembly Data Attribute mapping for Output Assemblies.

Data Component Name	Class		Instance	Attribute	
	Name	Number	Number	Name	Number
RunFwd	Supervisor	29hex	1	RunFwd	3
RunRev	Supervisor	29hex	1	RunRev	4
Fault Reset	Supervisor	29hex	1	FaultRst	11
NetCtrl	Supervisor	29hex	1	NetCtrl	5
DN Preset Cmd	Supervisor	29hex	1	DNPresetCmd	102
NetRef	AC Drive	2Ahex	1	NetRef	4
Speed Reference	AC Drive	2Ahex	1	SpeedRef	8
Internal Frequency	160 Param	B3	1	Internal Freq	58

**Class Code 0x04 —
Assembly Objects (Continued)**

Instance Data Format: Input Assemblies

Instance 50 Data Format (Basic Overload/Contactor Input Assembly)								
Byte	Bit 7	Bit 6	Bit 5	Bit 4	Bit 3	Bit 2	Bit 1	Bit 0
0								Faulted

Instance 51 Data Format (Extended Overload/Contactor Input Assembly)								
Byte	Bit 7	Bit 6	Bit 5	Bit 4	Bit 3	Bit 2	Bit 1	Bit 0
0			CtrlFrom Net					Faulted

Instance 52 Basic Motor Control								
Byte	Bit 7	Bit 6	Bit 5	Bit 4	Bit 3	Bit 2	Bit 1	Bit 0
0						Running1		Faulted/Trip

Instance 53 Extended Motor Control 1 (see table for functional assignments)								
Byte	Bit 7	Bit 6	Bit 5	Bit 4	Bit 3	Bit 2	Bit 1	Bit 0
0			CtrlFrom Net	Ready		Running1		Faulted/Trip

Instance 54 Extended Motor Control 2 (see table for functional assignments)								
Byte	Bit 7	Bit 6	Bit 5	Bit 4	Bit 3	Bit 2	Bit 1	Bit 0
0			CtrlFrom Net	Ready	Running2	Running1		Faulted/Trip

Instance 70 Data Format (Basic Speed Control Input Assembly)								
Byte	Bit 7	Bit 6	Bit 5	Bit 4	Bit 3	Bit 2	Bit 1	Bit 0
0						Running1		Faulted
1								
2					Speed Actual RPM (Low Byte)			
3					Speed Actual RPM (High Byte)			

Instance 71 Data Format (Extended Speed Control Input Assembly)								
Byte	Bit 7	Bit 6	Bit 5	Bit 4	Bit 3	Bit 2	Bit 1	Bit 0
0	At Reference	RefFrom Net	CtrlFrom Net	Ready	Running Reverse	Running Forward		Faulted
1								
2					Speed Actual RPM (Low Byte)			
3					Speed Actual RPM (High Byte)			

Class Code 0x04 — Assembly Objects (Continued)

Instance Data Format: Input Assemblies (Continued)

Instance 102 Attributes (Custom Parameter Based Input Assembly)

160 SSC Display parameter values are used to form the Output_Data structure for this assembly. Parameters 109, 110, 111, and 112 contain numbers of the parameter values that form this assembly. A value of 0 in any of the parameters 109 through 112 means end of assembly. For example, a value of 0 in parameter 110 means that the assembly will only be two bytes long, with parameter 109 containing the parameter number of the parameter whose value is placed in word 0 of the assembly.

Important: Setting Parameters 109, 110, 111, or 112 to a "9" causes the drive status to be mapped to the low byte and input status to be mapped to the high byte.

Word	Byte	
0	0	Value of parameter pointed to by Parameter Number 109 (Low Byte)
	1	Value of parameter pointed to by Parameter Number 109 (High Byte)
1	2	Value of parameter pointed to by Parameter Number 110 (Low Byte)
	3	Value of parameter pointed to by Parameter Number 110 (High Byte)
2	4	Value of parameter pointed to by Parameter Number 111 (Low Byte)
	5	Value of parameter pointed to by Parameter Number 111 (High Byte)
3	6	Value of parameter pointed to by Parameter Number 112 (Low Byte)
	7	Value of parameter pointed to by Parameter Number 112 (High Byte)

Instance 104: Allen-Bradley Input Assembly

This input assembly mirrors the Bulletin 1305 I/O Format.

Byte	Bit 7	Bit 6	Bit 5	Bit 4	Bit 3	Bit 2	Bit 1	Bit 0
0	Fault	N/A	Decel	Accel	Rot Dir ①	Cmd Dir ①	Running	Enabled
1	Freq Source ③	Freq Source ③	Freq Source ③	Freq Source ③	Local ②	Local ②	Local ②	At Speed
2	Actual Speed Scale 0-32767 ④							
3	Actual Speed Scale 0-32767 ④							

① 1 = forward, 0 = reverse

② Local

Bit 11	Bit 10	Bit 9	Definition
0	0	0	TB3 Control
0	0	1	Network Control

③ Frequency Source

Bit 15	Bit 14	Bit 13	Bit 12	Definition
0	0	0	0	Preset 0
0	0	0	1	Preset 1
0	0	1	0	Preset 2
0	0	1	1	Preset 3
0	1	0	0	Preset 4
0	1	0	1	Preset 5
0	1	1	0	Preset 6
0	1	1	1	Preset 7
1	0	0	0	TB3
1	0	0	1	Network
1	0	1	0	Not defined
1	1	1	1	Not defined

④ 0 = 0 Hz, 32767 = Maximum Frequency

**Class Code 0x04 —
Assembly Objects (Continued)**

Instance Data Format: Input Assemblies (Continued)

Instance 105: Allen-Bradley Drive Input Assembly with Parameters

160 SSC parameter values are used to form the Output_Data structure for this assembly. Parameters 111 and 112 contain numbers of the display parameter values that form this assembly. A value of 0 in either parameter 111 or 112 means end of assembly. For example, a value of 0 in parameter 112 means that the assembly will only be six bytes long, with parameter 111 containing the parameter number of the parameter whose value is placed in word 3 of the assembly.

Word	Byte	Bit 7	Bit 6	Bit 5	Bit 4	Bit 3	Bit 2	Bit 1	Bit 0
1	0	Fault	N/A	Decel	Accel	Rot Dir ①	Cmd Dir ①	Running	Enabled
	1	Freq Source ③	Freq Source ③	Freq Source ③	Freq Source ③	Local ②	Local ②	Local ②	At Speed
2	2	Actual Speed Scale 0-32767 ④							
	3	Actual Speed Scale 0-32767 ④							
3	4	Value of parameter pointed to by Parameter Number 111 (Low Byte)							
	5	Value of parameter pointed to by Parameter Number 111 (High Byte)							
4	6	Value of parameter pointed to by Parameter Number 112 (Low Byte)							
	7	Value of parameter pointed to by Parameter Number 112 (High Byte)							

① 1 = forward, 0 = reverse

② Local

Bit 11	Bit 10	Bit 9	Definition
0	0	0	TB3 Control
0	0	1	Network Control

③ Frequency Source

Bit 15	Bit 14	Bit 13	Bit 12	Definition
0	0	0	0	Preset 0
0	0	0	1	Preset 1
0	0	1	0	Preset 2
0	0	1	1	Preset 3
0	1	0	0	Preset 4
0	1	0	1	Preset 5
0	1	1	0	Preset 6
0	1	1	1	Preset 7
1	0	0	0	TB3
1	0	0	1	Network
1	0	1	0	Not defined
1	1	1	1	Not defined



④ 0 = 0 Hz, 32767 = Maximum Frequency

The following table indicates the I/O Assembly Data Attribute mapping for Input Assemblies.



Data Component Name	Class		Instance Number	Attribute	
	Name	Number		Name	Number
Faulted	Supervisor	29hex	1	Faulted	9
Running 1 (Fwd)	Supervisor	29hex	1	RunningFwd	7
Running 2 (Rev)	Supervisor	29hex	1	RunningRev	8
Ready	Supervisor	29hex	1	Ready	9
CtrlFromNet	Supervisor	29hex	1	CtrlFromNet	15
CtrlFromNet	AC Drive	2Ahex	1	RefFromNet	29
At Reference	AC Drive	2Ahex	1	AtReference	3
Speed Actual	AC Drive	B3hex	1	SpeedActual	7

Class Code 0x04 — Configuration Assembly Data Formats Assembly Objects (Continued)

Instance 191 Data Format (Fixed Configuration Assembly – All Preset Speed Models)

Config Num.	Parameter Number	Description	Size	Config Num.	Parameter Number	Description	Size
1	30	Accel Time 1	2	17	46	Input Mode 	1
2	31	Decel Time 1	2	18	47	Output Configuration	1
3	32	Minimum Freq	1	19	48	Output Threshold	2
4	33	Maximum Freq	2	20	49	PWM Frequency	1
5	34	Stop Mode Select 	1	21	50	Restart Tries	1
6	35	Base Frequency	2	22	51	Restart Time	2
7	36	Base Voltage	2	23	61	Preset Freq 0	2
8	37	Maximum Voltage	2	24	62	Preset Freq 1	2
9	38	Boost Select	1	25	63	Preset Freq 2	2
10	39	Skip Frequency	2	26	64	Preset Freq 3	2
11	40	Skip Freq Band	1	27	65	Preset Freq 4	2
12	41	Overload Select	1	28	66	Preset Freq 5	2
13	42	Motor Overload	2	29	67	Preset Freq 6	2
14	43	Current Limit	1	30	68	Preset Freq 7	2
15	44	DC Hold Time	1	31	69	Accel Time 2	2
16	45	DC Hold Voltage	1	32	70	Decel Time 2	2

Instance 192 Data Format (Fixed Configuration Assembly – All Signal Follower Models)

Config Num.	Parameter Number	Description	Size	Config Num.	Parameter Number	Description	Size
1	30	Accel Time 1	2	13	42	Motor Overload	2
2	31	Decel Time 1	2	14	43	Current Limit	1
3	32	Minimum Frequency	1	15	44	DC Hold Time	1
4	33	Maximum Frequency	2	16	45	DC Hold Voltage	1
5	34	Stop Mode Select 	1	17	46	Input Mode 	1
6	35	Base Frequency	2	18	47	Output Configuration	1
7	36	Base Voltage	2	19	48	Output Threshold	2
8	37	Maximum Voltage	2	20	49	PWM frequency	1
9	38	Boost Select	1	21	50	Restart Tries	1
10	39	Skip Frequency	2	22	51	Restart Time	2
11	40	Skip Freq Band	1	23	53	S-Curve	1
12	41	Overload Select	1				



ATTENTION: Changing this parameter value may cause unpredictable network conditions, resulting in equipment damage, personal injury, or death. Ensure that you understand how changing this parameter affects your application.

**Class Code 0x04 —
Assembly Objects (Continued)**

Configuration Assembly Data Formats (Continued)

Instance 193 Data Format (Fixed Configuration Assembly – DeviceNet Module)			
Config Num.	Parameter Number	Description	Size
1	None	Reserved	1
2	114	Motor Base RPM	2
3	113	DN Fault Mode	1
4	107	Output Assembly	1
5	108	Input Assembly	1
6	103	NV MAC ID	1
7	104	NV Baud	1
8	109	Assembly Word 0	1
9	110	Assembly Word 1	1
10	111	Assembly Word 2	1
11	112	Assembly Word 3	1
12	115	DN Idle Mode	1
13	117	COS	2
14	118	Local Return Md	1
15	105	Bus Off Error	1

B

baud rate (data rate)
factory default, **3-7**
settings, **3-7**

C

Change of State (COS) data exchange
configuring scanner for, **6-12**

COMM LED

locating, **7-1**
troubleshooting with, **7-2**

common mode noise reduction, **3-4**

communication module

installing, **3-8**
powering up, **4-1**
removing from drive, **3-10**
wiring, **3-9**

configuration switches, **3-5**

configuring drive input mode, **6-7**

ControlLogix

example I/O messaging program, **6-17**
formatting Explicit Messages, **6-23**

Cyclic data exchange

configuring scanner for, **6-12**

D

data rate, *see* **baud rate**

DeviceNet wiring, **3-9**

DIP switches

baud rate (data rate), **3-7**
DeviceNet node address, **3-6**
locating, **3-5**

drive output disconnect guidelines, **3-4**

E

EDS files

creating, **6-3**
description, **5-1**

Electronic Data Sheets, *see* **EDS files**

equipment required, **3-1**

error mode, **4-2**

Explicit Messages

example for ControlLogix, **6-30**
example for PLC-5, **6-33**
example for SLC, **6-35**
using ControlLogix, **6-23**
using PLC-5, **6-26**
using SLC, **6-26**

F

factory default

baud rate (data rate), **3-7**
DeviceNet node address, **3-6**

FAULT LED

locating, **7-1**
troubleshooting with, **7-3**

G

getting started

overview for experienced users, **2-1**
Quick Start procedures, **2-2**

I

I/O

configuring scanner for, **6-13**
mapping the input, **6-13**
mapping the output, **6-15**
messaging example for ControlLogix, **6-17**
messaging example for PLC-5, **6-19**
messaging example for SLC, **6-21**

input assemblies

Instance Data Format for, **B-26 to B-28**
selecting, **6-5**

installing communication module, **3-8**

L

LEDs, *see* **COMM LED**, **FAULT LED** or **READY LED**

M

modes of operation

error mode, **4-2**

power-up reset mode, **4-1**

run mode, **4-2**

modifying drive reset functions, **6-8**

module installation, **3-1**

N

Non-Volatile Storage (NVS), **6-23**

O

output assemblies

Instance Data Format for, **B-24 to B-25**

selecting, **6-5**

P

parameters, **5-3 to 5-10**

PLC-5

example I/O messaging program, **6-19**

formatting Explicit Messages, **6-26**

Polled data exchange

configuring scanner for, **6-12**

power-up reset mode, **4-1**

Q

quick start

for experienced users, **2-1**

R

READY LED

locating and description, **7-1**

removing communication module, **3-10**

removing keypad, **3-5**

removing Read/Fault panel, **3-5**

required equipment, **3-1**

run mode, **4-2**

S

scanner

configuring for Polled, COS or Cyclic, **6-12**

mapping the drive data, **6-13**

setting up the scan list, **6-11**

SLC

example I/O messaging program, **6-21**

formatting Explicit Messages, **6-26**

specifications, **A-1**

start-up instructions, **2-1**

status LEDs, *see* **COMM LED**, **FAULT LED** or **READY LED**

surge suppression, **3-2**

switches

locating and factory settings, **3-5**

T

tools required, **3-1**

troubleshooting, **7-1**

W

wiring

communication module, **3-9**

DeviceNet connector, **3-9**

www.rockwellautomation.com

Power, Control and Information Solutions Headquarters

Americas: Rockwell Automation, 1201 South Second Street, Milwaukee, WI 53204-2496 USA, Tel: (1) 414.382.2000, Fax: (1) 414.382.4444

Europe/Middle East/Africa: Rockwell Automation, Vorstlaan/Boulevard du Souverain 36, 1170 Brussels, Belgium, Tel: (32) 2 663 0600, Fax: (32) 2 663 0640

Asia Pacific: Rockwell Automation, Level 14, Core F, Cyberport 3, 100 Cyberport Road, Hong Kong, Tel: (852) 2887 4788, Fax: (852) 2508 1846

Publication 0160-5.18 – June, 2003
Supersedes 0160-5.18 – March, 1999

P/N 193557-P02
Copyright © 2003 Rockwell Automation, Inc. All rights reserved. Printed in USA.