

Miniature Guide Rod Cylinder

MGJ Series

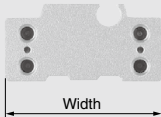

Non-rotating accuracy: $\pm 0.1^\circ$



- Mounting from 2 directions

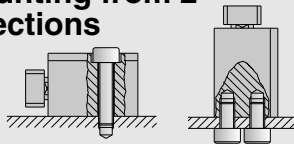

- Two auto switches can be mounted even for 5 mm strokes
- Integral wiring/piping to one direction



Dimensions

Unit: mm

Bore size	Overall length	Width	Height
6	23 + Stroke	29	14.5
10	25 + Stroke	33	17

Weight

Unit: g

Bore size (mm)	Standard stroke (mm)			
	5	10	15	20
6	27.3	33.0	38.4	—
10	40.6	48.0	55.6	63.2

Series Variations

Series	Bore size (mm)	Guide rod size (mm)	Standard stroke (mm)				Cushion	Auto switch
			5	10	15	20		
MGJ	6	5	●	●	●	—	Rubber bumper (Both sides)	D-F8□
	10	6	●	●	●	●		

MGJ

JMGP

MGP

MGPW

MGQ

MGG

MGC

MGF

MGZ

MGT

D-□

-X□

Miniature Guide Rod Cylinder

MGJ Series

ø6, ø10

How to Order

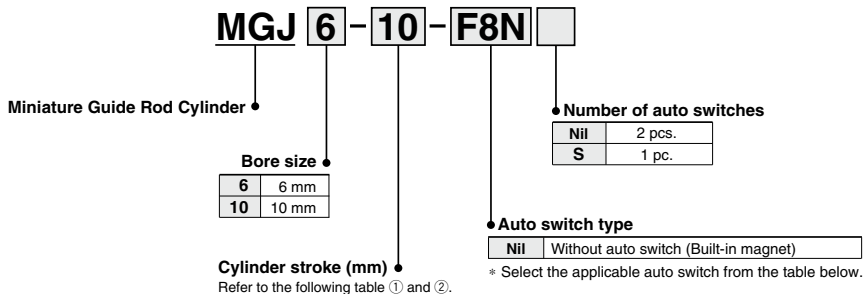

Table ① Standard Strokes

Bore size (mm)	Standard stroke (mm)
6	5, 10, 15
10	5, 10, 15, 20

Table ② Intermediate Stroke (by the 1 mm stroke)

Bore size (mm)	Applicable stroke (mm)
6	1 to 15 (Spacer type)
10	1 to 20 (Spacer type)
Example	Model no.: MGJ6-9 Installing a 1 mm width spacer for MGJ6-10 External size: same as MGJ6-10

* The minimum auto switch mounting stroke is 4 mm.

Applicable Auto Switches/Refer to pages 1119 to 1245 for detailed auto switch specifications.

Type	Special function	Electrical entry	Indicator light	Wiring (output)	Load voltage		Auto switch part no.			Applicable load		
							Direct mounting	Lead wire length (m)				
					DC	5 V		12 V	0.5 (Nil)	3 (L)	5 (Z)	
Solid state auto switch	-	Grommet (Perpendicular)	Yes	3-wire (NPN)	24 V	5 V	F8N	●	●	○	IC circuit	Relay PLC
				3-wire (PNP)		12 V	F8P	●	●	○		
				2-wire		12 V	F8B	●	●	○	-	

* Lead wire length symbols: 0.5 m Nil (Example) F8N
 3 m L (Example) F8NL
 5 m Z (Example) F8NZ

* Auto switches marked with ○ are produced upon receipt of order.
 * When using non-applicable auto switches, please consult with SMC.
 * Auto switch is shipped together (not assembled).



Caution

This product should not be used as a stopper.

Symbol

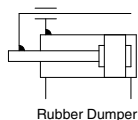

Specifications

Bore size (mm)	6	10
Action	Double acting	
Fluid	Air	
Proof pressure	1.05 MPa	
Maximum operating pressure	0.7 MPa	
Minimum operating pressure	0.15 MPa	
Ambient and fluid temperature	-10 to 60°C (No freezing)	
Cushion	Rubber bumper at both ends	
Lubrication	Non-lube	
Piston speed	50 to 500 mm/s ^(Note)	
Stroke length tolerance	+1.0 0 mm	
Port size	M3 x 0.5	
Guide size	ø5	ø6

(Note) Within allowable kinetic energy use only

Theoretical Output

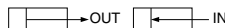

Unit: N

Bore size (mm)	Rod size (mm)	Operating direction	Piston area (mm ²)	Operating pressure (MPa)			
				0.15	0.3	0.5	0.7
6	3	OUT	28.3	4.24	8.48	14.15	19.81
		IN	21.2	3.18	6.36	10.60	14.84
10	5	OUT	78.5	11.77	23.55	39.25	54.95
		IN	58.9	8.83	17.67	29.45	41.23

Weight

Unit: g

Bore size (mm)	Standard stroke (mm)			
	5	10	15	20
6	27.3	33.0	38.4	—
10	40.6	48.0	55.6	63.2

Allowable Rotational Torque of Plate

For the rotational torque (T) added to the plate (rod end), use a value no more than the values in the table. Operation outside of this range may cause excessive impact, which may result in the damage to the devices.

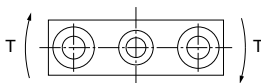

Unit: cN·m

Bore size (mm)	Stroke (mm)			
	5	10	15	20
6	0.92	0.73	0.61	—
10	4.75	3.96	3.36	2.87

Plate Non-rotating Accuracy

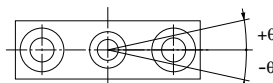

Bore size (mm)	Non-rotating accuracy θ
6	$\pm 0.1^\circ$
10	

* When extending the cylinder (initial value), non-rotating accuracy θ , without loads and deflection of guide rods, it should be a value no more than the value in the table as a guide.

Moisture Control Tube IDK Series



When operating an actuator with a small diameter and a short stroke at a high frequency, the dew condensation (water droplet) may occur inside the piping depending on the conditions.

Simply connecting the moisture control tube to the actuator will prevent dew condensation from occurring. For details, refer to [the IDK series in the Best Pneumatics No. 6](#).

MGJ

JMGP

MGP

MGPW

MGQ

MGG

MGC

MGF

MGZ

MGT

D-□

-X□

Allowable Kinetic Energy

When driving the cylinder with inertial load, keep kinetic energy no more than the allowable value. The area between bold lines in the below graphic shows the relation between load mass and maximum speed.

Bore size (mm)	6	10
Operating piston speed (m/s)	0.05 to 0.5	
Allowable kinetic energy (J)	0.012	0.035

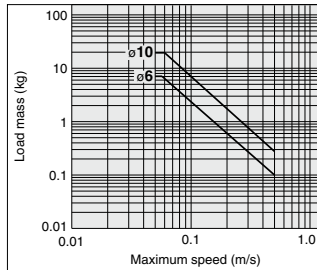

Allowable Eccentric Load

Make sure that the load mass (W) is within the range in the graph below when there is an eccentric distance (L) from the center of the cylinder. Using cylinders are beyond the limit may shorten the product service life or cause damage.

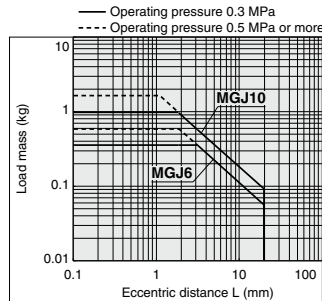
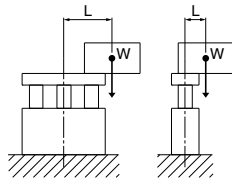

Construction

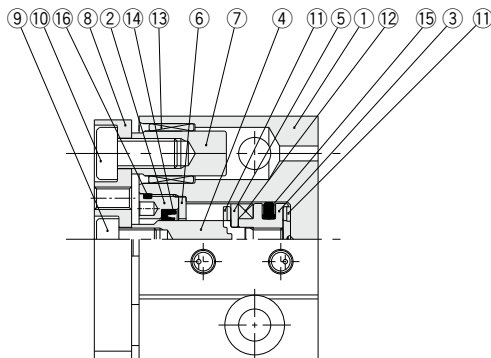
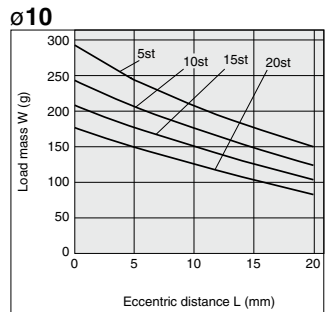
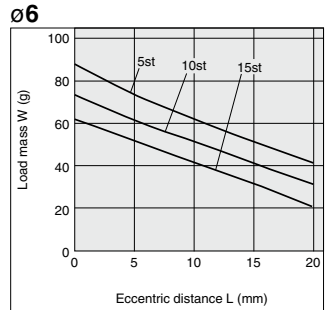
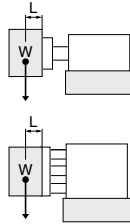

Plate Allowable Lateral Load

When the eccentric distance (L) generates from the plate (rod end), be sure to keep the load mass (W) no more than a value in the below graphic. Operation outside of this range may cause excessive impact, which may result in the damage to the devices.



Parts list

No.	Description	Material	Note
1	Body	Aluminum alloy	Hard anodized
2	Rod cover	Aluminum alloy	Chromated
3	Piston	Aluminum alloy	Chromated
4	Piston rod	Stainless steel	
5	Magnet retainer	Aluminum alloy	Chromated, in case of ø6
		Stainless steel	In case of ø10
6	Seal retainer	Aluminum alloy	Chromated, in case of ø6
		Stainless steel	In case of ø10
7	Guide rod	Carbon steel	Hard chromium electroplated
8	Plate	Aluminum alloy	Hard anodized
9	Torque socket head bolt	Carbon steel	Nickel plated, in case of ø6
	Hexagon socket head cap screw	Carbon steel	Nickel plated, in case of ø10
10	Brazer head hexagon socket bolt	Carbon steel	Nickel plated
11	Bumper	Resin	
12	Magnet	—	
13	Bushing	Bearing alloy	
14	Rod seal	NBR	
15	Piston seal	NBR	
16	O-ring	NBR	

Dimensions

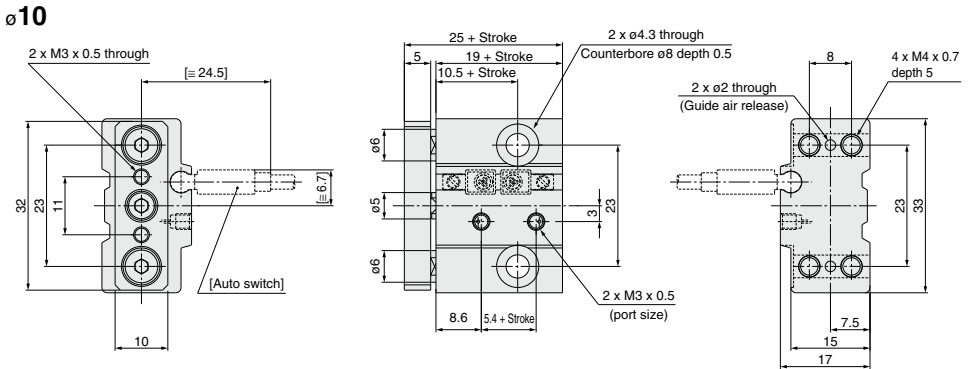
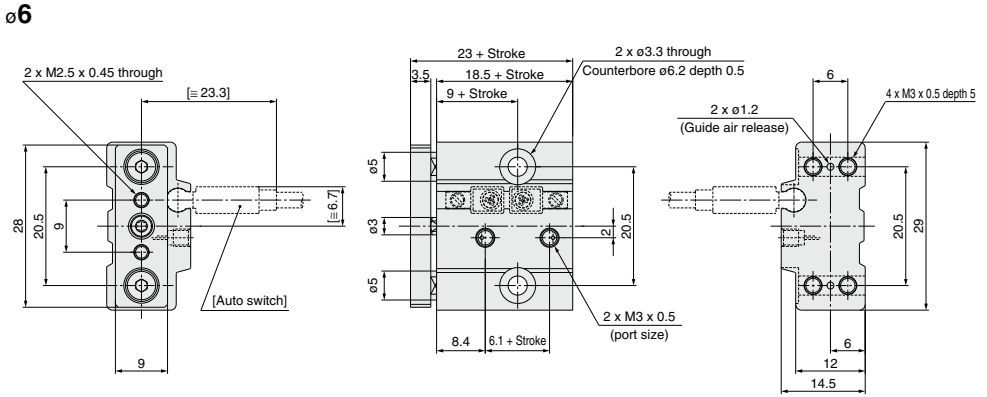

* For intermediate strokes other than standard strokes, refer to the Manufacture of Intermediate Stroke on page 402.

MGJ

JMGP

MGP

MGPW

MGQ

MGG

MGC

MGF

MGZ

MGT

D-□

-X□

MGJ Series Auto Switch Mounting

Auto Switch Proper Mounting Position (Detection at Stroke End)

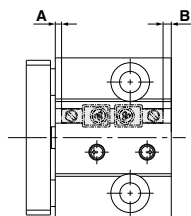

Bore size	A	B	Operating range
ø6	1.6	0.9	3
ø10	1.3	1.7	4

(mm)

Auto Switch Mounting

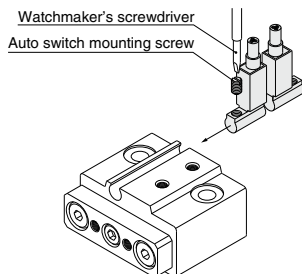

- Use a watchmaker's screwdriver with a handle about 5 to 6 mm in diameter when tightening the auto switch mounting screw.
- Tightening torque of auto switch mounting screw should be set 0.10 to 0.20 N·m.



MGJ Series

Specific Product Precautions

Be sure to read this before handling the products.

Refer to back page 50 Safety Instructions and pages 3 to 12 for Actuator and Auto Switch Precautions.

Mounting

⚠ Warning

1. Do not put hands or fingers, etc. between the plate and body.

Care should be taken that hands or fingers do not get caught in between the cylinder body and the plate when air pressure is applied.

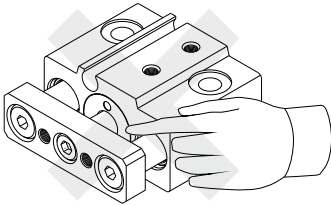

⚠ Caution

1. Do not scratch or dent the sliding parts of the piston rod and guide rods.

Damage to seals can cause air leakage or malfunction, etc.

2. When mounting the miniature guide rod cylinder with screws, do not exceed the maximum tightening torque.

(The torque may vary depending on the material of the mounting side.)

Model	Bolt	Maximum tightening torque (N·m)	
		Top mounting	Bottom mounting
MGJ6	M3 x 0.5	1.2	0.3
MGJ10	M4 x 0.7	2.7	0.7

Top mounting

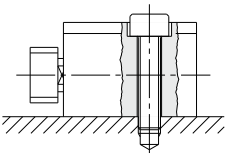

Bottom mounting

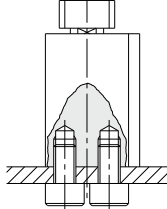

Lubrication

⚠ Caution

1. Lubricating the non-lube type cylinder

The cylinder has been lubricated for life at the factory and can be used without any further lubrication.

When lubricating the cylinder, apply the polyalphaolefin oil or its equivalent.

Stopping lubrication later may lead to malfunction because the new lubricant will displace the original lubricant. Therefore, lubrication must be continued once it has been started.

Mounting

⚠ Caution

3. Flatness of mounting surface should be less than 0.02 mm.

When mounting Miniature Guide Rod Cylinder, or mounting plate to work piece, sideling mounting surface may cause malfunction.

4. Be sure that the piston rod is extended before mounting loads.

If loads are mounted to the plate when the piston rods are retracted, it can lead to distortion of the guides resulting in malfunction.

5. When mounting the load with screws, do not exceed the maximum tightening torque.

(The torque may vary depending on the material of the load.)

Model	Bolt	Maximum tightening torque (N·m)
MGJ6	M2.5 x 0.45	0.5
MGJ10	M3 x 0.5	1.0

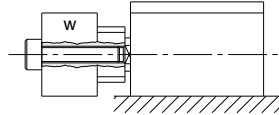

6. When the cylinder output is directly applied to the moving parts of the cylinder, such as when clamping a workpiece, be sure to apply the cylinder output to the center of the cylinder (along the rod axial line).

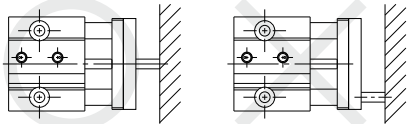

Others

⚠ Caution

1. This product should not be used as a stopper.

MGJ

JMGP

MGP

MGPW

MGQ

MGG

MGC

MGF

MGZ

MGT

D-□

-X□